



walther
präzision

WalCoDo®

WALTHER CONNECTING & DOCKING

H₂

Hydrogen Refueling System



Series HG



The WALTHER **high pressure refueling system** of the HG series is developed for safe and fast refueling with gaseous hydrogen. The usual application is the refueling of vehicles with fuel cell drive up to an operating pressure of 87.5 MPa / 12,688 psi.

The refueling nozzles are tested and validated according to SAE J2600 and ISO 17268, the worldwide standards for refueling interfaces.

Since 2006 WALTHER-PRÄZISION has significantly contributed to set the standards for high-pressure hydrogen technology, offering today validated systems for the mobility of the future.



Hydrogen Refueling System

Product finder

Image*	Description	Feature + Options	Max. Operating Pressures [MPa / psi]	Operating Temperatures [°C / F]	WALTHER Types	Page
	Refueling Nozzle for gaseous hydrogen acc. to SAE J2600, SAE J2799, ISO 19880, ISO 17268 and HGV 4.1	<ul style="list-style-type: none"> • With or without IR module • Easy push / pull technology • Pressure enabled unlocking system for highest safety 	87.5 12,688	-40 to +85 -40 to +185	(up to 87,5 MPa) HG-004-0 (up to 43,8 MPa) HG-008-0	4 - 6
	Breakaway Coupling for non-destructive emergency separation between dispenser and hose set / nozzle acc. to ISO 19880 and HGV 4.4	<ul style="list-style-type: none"> • Safe removal of residual pressure with venting tool • 600 N (approx) separation force • Shut of valves 	87.5 12,688	-40 to +85 -40 to +185	HG-008-B	8 - 11
	Parking Station / Holster for safe parking of the refueling nozzle	<ul style="list-style-type: none"> • Integrated purging system „Dry Connect“ and actuation system • Housing: stainless steel 		-40 to +85 -40 to +185	HG-004-B-0006-AAAV-Y14	12 - 13
	Hose Set for the reliable connection between refuelling nozzle and breakaway coupling acc. to ISO 19880	<ul style="list-style-type: none"> • Hose length 4000 mm • Including IR connection cable and protection hose 	87.5 12,688	-40 to +85 -40 to +185	HG-004-B	14
	Special Tool Venting Tool for a safe pressure relief after separation	<ul style="list-style-type: none"> • Easy to operate • Safe removal of residual pressure between nozzle and breakaway coupling 	87.5 12,688	-40 to +85 -40 to +185	HG-008-9	15
	Special Tool IR exchange tool	<ul style="list-style-type: none"> • Easy to operate 			HG-004-550-0GAA-Y18	15
	Refueling Receptacle for gaseous hydrogen acc. to SAE J2600, suitable for bulkhead connection	<ul style="list-style-type: none"> • Connection 9/16-18 UNF 2B (inner thread) • Dust cap included 	87.5 12,688	-40 to +85 -40 to +185	HG-004-9 HG-008-9	16

*All illustrations subject to technical changes

We would be happy to provide you with support and advice. Please contact us:



+49 (0) 2129 / 567-402



info@walther-praezision.de





Refueling Nozzle Series HG



Characteristics:

- Double locking technology
- Pressure-active locking system (form fit)
- IR module exchangeable on-site
- Ergonomic design with push-pull technology
- Correctly coupled indication

Benefits:

- Locking before valve opens
- Disconnecting under pressure safely prevented
- Maintenance and service friendly = low service costs
- Simple and reliable operation = high customer acceptance
- Visual check "safely connected"

Available nozzle	Flow rates [g/s]	Operating pressure max. [MPa]	Nominal pressure [MPa]	Cv value
35 MPa / NF*	30	43,8	35	0,55
35 MPa / HF*	120	43,8	35	0,55
70 MPa / NF*	60	87,5	70	0,2

* NF = Normal flow / HF = High flow



Refueling Nozzle Series HG

Feature chart | Refueling Nozzle

Technical features	Construction / Materials	Options
<ul style="list-style-type: none"> High safety by double locking technology and pressure-active locking system Light weight for easy handling Suitable for ultra-cold refueling until -40°C gas temperature With IR technology according to SAE J2601 including ATEX (or KTL / NEC / CCC) IR module can be exchanged on-site Tested and validated according to SAE J2600, SAE J2799, ISO 19880, ISO 17268 and HG V 4.1 Manufactured according to DIN EN 10204-3.1 	<p>Material Stainless steel, POM black/blue</p> <p>Seals PEEK / NBR / HNBR / TPU</p>	<ul style="list-style-type: none"> Other pressure ratings on request Without IR module

High pressure refueling nozzle

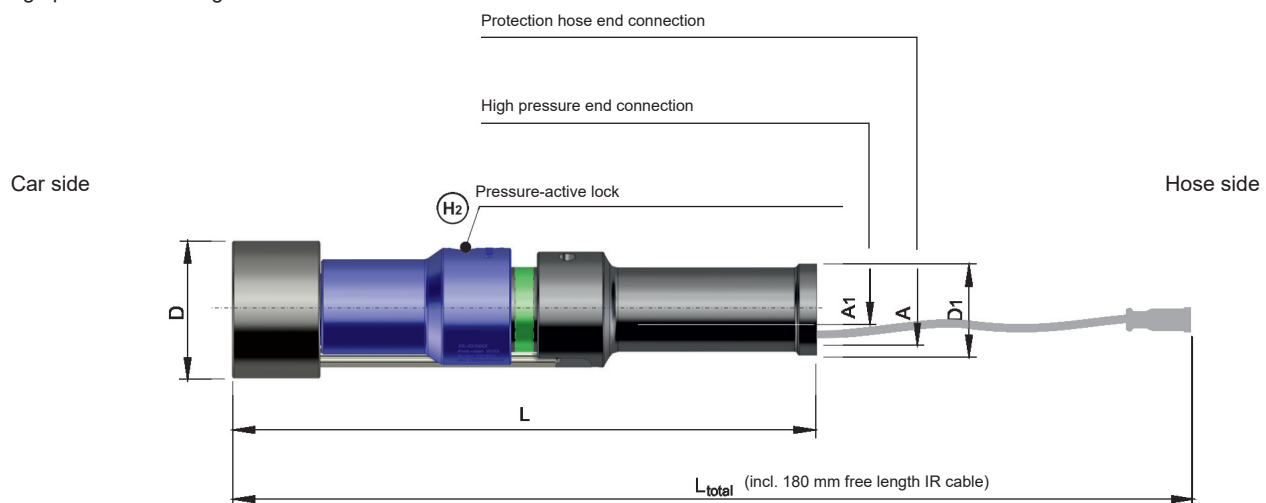

NB	Product type	A	A1	D / D ₁ [mm]	L / L _{total} [mm]	Nominal / maximal-pressure [MPa]	Weight [kg]	ID	Part number	Cable length [mm]
4	70 MPa - NF* Refueling Nozzle (ATEX, NEC)	M40x1,5	9/16-18 UNF with sealing cone 60°	75 / 50	319 / 500	70 / 87,5	1,82	227960	HG-004-0-XX004- AABA-Y016-BB- S070	500
4	70 MPa - NF* Refueling Nozzle (KTL)	M40x1,5	9/16-18 UNF with sealing cone 60°	75 / 50	319 / 500	70 / 87,5	1,82	237580	HG-004-0-XX004- NBAD-Y016-BB- S070-A0086	500
4	70 MPa - NF* Refueling Nozzle (KTL)	M40x1,5	9/16-18 UNF with sealing cone 60°	75 / 50	319 / 500	70 / 87,5	1,88	238258	HG-004-0-XX004- NBAD-Y019-BB- A0086-S070	6000
4	70 MPa - NF* Refueling Nozzle (CCC)	M40x1,5	9/16-18 UNF with sealing cone 60°	75 / 50	319 / 500	70 / 87,5	1,82	238259	HG-004-0-XX004- NBAA-Y016-BB- A0151-S070	500
4	70 MPa - NF* Refueling Nozzle (without IR Module)	M40x1,5	9/16-18 UNF with sealing cone 60°	75 / 50	319 / 500	70 / 87,5	1,72	237583	HG-004-0-XX004- NBAB-Y017-BB- S070	500

* NF = Normal flow / HF = High flow



Refueling Nozzle Series HG

Feature chart | Refueling Nozzle

NB	Product type	A	A ₁	D / D ₁ [mm]	L [mm]	Nominal / maximal- pressure [MPa]	Weight [kg]	ID	Part number	Cable length [mm]
8	35 MPa - NF* Refueling Nozzle (ATEX, NEC)	M40 x 1,5	9/16-18 UNF with sealing cone 60°	75 / 50	319	35 / 43,8	1,82	227979	HG-008-0-XX002- NBAA-Y016-BB-S035	500
8	35 MPa - NF* Refueling Nozzle (ATEX, NEC)	M40 x 1,5	9/16-18 UNF with sealing cone 37°	75 / 50	319	35 / 43,8	1,82	237912	HG-008-0-XX005- NBAA-Y016-BB-S035	500
8	35 MPa - NF* Refueling Nozzle (ATEX, NEC)	M40 x 1,5	7/16-20 UNF with sealing cone 37°	75 / 50	319	35 / 43,8	1,82	238811	HG-008-0-XX010- NBAA-Y016-BB-S035	500
8	35 MPa - NF* Refueling Nozzle (KTL)	M40 x 1,5	9/16-18 UNF with sealing cone 37°	75 / 50	319	35 / 43,8	1,82	237783	HG-008-0-XX005- NBAA-Y016-BB- A0086-S035	500
8	35 MPa - NF* Refueling Nozzle (KTL)	M40 x 1,5	7/16-20 UNF with sealing cone 37°	75 / 50	319	35 / 43,8	1,82	238813	HG-008-0-XX010- NBAA-Y016-BB- A0086-S035	500
8	35 MPa - NF* Refueling Nozzle (KTL)	M40 x 1,5	9/16-18 UNF with sealing cone 37°	75 / 50	319	35 / 43,8	1,88	238260	HG-008-0-XX005- NBAA-Y019-BB- A0086-S035	6000
8	35 MPa - NF* Refueling Nozzle (KTL)	M40 x 1,5	7/16-20 UNF with sealing cone 37°	75 / 50	319	35 / 43,8	1,88	238814	HG-008-0-XX010- NBAA-Y019-BB- A0086-S035	6000
8	35 MPa - NF* Refueling Nozzle (CCC)	M40 x 1,5	9/16-18 UNF with sealing cone 37°	75 / 50	319	35 / 43,8	1,82	238272	HG-008-0-XX005- NBAA-Y016-BB- A0151-S035	500
8	35 MPa - NF* Refueling Nozzle (CCC)	M40 x 1,5	7/16-20 UNF with sealing cone 37°	75 / 50	319	35 / 43,8	1,82	238815	HG-008-0-XX010- NBAA-Y016-BB- A0151-S035	500
8	35 MPa - NF* Refueling Nozzle (without IR Module)	M40 x 1,5	9/16-18 UNF with sealing cone 37°	75 / 50	319	35 / 43,8	1,72	238271	HG-008-0-XX005- NBAA-Y017-BB-S035	500
8	35 MPa - NF* Refueling Nozzle (without IR Module)	M40 x 1,5	7/16-20 UNF with sealing cone 37°	75 / 50	319	35 / 43,8	1,72	238812	HG-008-0-XX010- NBAA-Y017-BB-S035	500
8	35 MPa - HF* Refueling Nozzle (ATEX, NEC)	M40 x 1,5	9/16-18 UNF with sealing cone 60°	75 / 50	319	35 / 43,8	1,82	233430	HG-008-0-XX005- NBAA-Y016-BB- THF-S035	500
8	35 MPa - HF* Refueling Nozzle (ATEX, NEC)	M40 x 1,5	3/4-16 UNF with sealing cone 37°	75 / 50	319	35 / 43,8	1,82	238817	HG-008-0-XX012- NBAA-Y016-BB- THF-S035	500
8	35 MPa - HF* Refueling Nozzle (KTL)	M40 x 1,5	9/16-18 UNF with sealing cone 37°	75 / 50	319	35 / 43,8	1,82	238274	HG-008-0-XX005- NBAA-Y016-BB- THP-A0086-S035	500
8	35 MPa - HF* Refueling Nozzle (KTL)	M40 x 1,5	9/16-18 UNF with sealing cone 37°	75 / 50	319	35 / 43,8	1,88	238275	HG-008-0-XX005- NBAA-Y019-BB- THF-A0086-S035	6000

*NF = Normal flow / HF = High flow



Refueling Nozzle Series HG

Feature chart | Refueling Nozzle

NB	Product type	A	A1	D / D ₁ [mm]	L [mm]	Nominal / maximal- pressure [MPa]	Weight [kg]	ID	Part number	Cable length [mm]
8	35 MPa - HF* Refueling Nozzle (KTL)	M40 x 1,5	3/4-16 UNF with sealing cone 37°	75 / 50	319	35 / 43,8	1,88	238819	HG-008-0-XX012- NBAA-Y016-BB- THF-A0086-S035	500
8	35 MPa - HF* Refueling Nozzle (KTL)	M40 x 1,5	3/4-16 UNF with sealing cone 37°	75 / 50	319	35 / 43,8	1,88	238820	HG-008-0-XX012- NBAA-Y019-BB- THF-A0086-S035	6000
8	35 MPa - HF* Refueling Nozzle (CCC)	M40 x 1,5	9/16-18 UNF with sealing cone 37°	75 / 50	319	35 / 43,8	1,82	238276	HG-008-0-XX005- NBAA-Y016-BB- THF-A0151-S035	500
8	35 MPa - HF* Refueling Nozzle (CCC)	M40 x 1,5	3/4-16 UNF with sealing cone 37°	75 / 50	319	35 / 43,8	1,82	238821	HG-008-0-XX012- NBAA-Y016-BB- THF-A0151-S035	500
8	35 MPa - HF* Refueling Nozzle (without IR Module)	M40 x 1,5	9/16-18 UNF with sealing cone 37°	75 / 50	319	35 / 43,8	1,72	238273	HG-008-0-XX005- NBAA-Y017-BB- THF-S035	500
8	35 MPa - HF* Refueling Nozzle (without IR Module)	M40 x 1,5	3/4-16 UNF with sealing cone 37°	75 / 50	319	35 / 43,8	1,72	238818	HG-008-0-XX012- NBAA-Y017-BB- THF-S035	500

*NF = Normal flow / HF = High flow





Breakaway Coupling Series HG



Characteristics:

- Unique and IP protected system with integrated pressure compensation
- Unlimited release angles in all directions due to flexible suspension
- Non-destructive emergency release
- After release venting of high pressure line with special tool possible (see page 15)

Benefits:

- Blow-back proven design for near-to-pressure-neutral emergency release
- Constant and fixed level of required emergency release forces
- Highest level of safety while and directly after an emergency event
- Quick and easy restoring of the operational readiness on site



Breakaway Coupling Series HG

Feature chart | Breakaway Coupling

Technical features	Construction / Materials	Options
<ul style="list-style-type: none"> Suitable for ultra-cold refueling until -40°C gas temperature in connection with WALTHER refueling system For operating pressures 43,8 MPa or 87.5 MPa Electrical plug for emergency separation (IR signals) Impact protection ring Fixed emergency separation force (approx. 600 N) Safe initiation of emergency separation by reliable deviation of suspension and automatic shut-off of hydrogen flow After emergency separation, simple and onside recovery by manual connection Tested and validated acc. to ISO 19880 and HGV 4.4 Manufactured according to DIN EN 10204-3.1 	<p>Material Stainless steel, PUR</p> <p>Seals PEEK / NBR / HNBR / TPU</p>	<ul style="list-style-type: none"> Other pressure ratings on request Venting tool (see page 15)

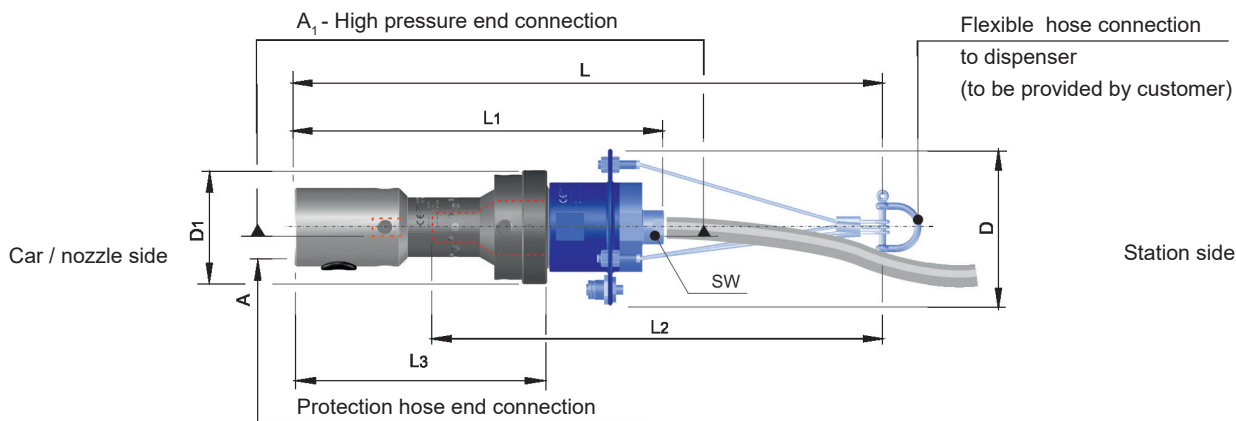

Product chart | Breakaway Coupling Sets

NB	Product type	A	A ₁	SW	D / D ₁ [mm]	L / L ₁ [mm]	Nominal / maxial-pressure [MPa]	Weight [kg]	ID	Part number	Cable
8	70 MPa - NF* Breakaway coupling complete	M40 x 1,5 (female)	9/16-18 UNF with sealing cone 60°	21	127 / 76	440 / 260	70 / 87,5	4,8	233433	HG-008-B-02000-ACFA-Y216-BB-S070	LEMO
8	35 MPa - NF* Breakaway coupling complete	M40 x 1,5 (female)	9/16-18 UNF with sealing cone 37°	21	127 / 76	440 / 260	35 / 43,8	4,8	233434	HG-008-B-02001-ACFA-Y216-BB-S035	LEMO
8	35 MPa - NF* Breakaway coupling complete	M40 x 1,5 (female)	7/16-20 UNF with sealing cone 37°	21	127 / 76	440 / 260	35 / 43,8	4,8	238822	HG-008-B-02010-ACFA-Y216-BB-S035	LEMO
8	35 MPa - HF* Breakaway coupling complete	M40 x 1,5 (female)	9/16-18 UNF with sealing cone 37°	21	127 / 76	440 / 260	35 / 43,8	4,8	233437	HG-008-B-02001s-ACFA-Y216-BB-THF S035	LEMO
8	35 MPa - HF* Breakaway coupling complete	M40 x 1,5 (female)	3/4-16 UNF with sealing cone 37°	21	127 / 76	440 / 260	35 / 43,8	4,8	238823	HG-008-B-02020-ACFA-Y216-BB-THF S035	LEMO

* NF = Normal flow / HF = High flow



Product Chart Breakaway Coupling (Station side)

NB	Product type	A	A ₁	SW [mm]	D / D ₁ [mm]	L ₂ [mm]	Nominal / maximal-pressure [MPa]	Weight [kg]	ID	Part number	Cable
8	70 MPa - NF* Breakaway coupling	-	9/16-18 UNF-2B 3/8" with sealing cone 60°	21	115 / 127	340	70 / 87,5	1,9	229923	HG-008-0-XX004- ACAA-Y216-BB-S070	LEMO
8	35 MPa - NF* Breakaway coupling	-	9/16-18 UNF-2B Nova Swiss 3/8" with sealing cone 60°	21	115 / 127	340	35 / 43,8	1,9	227754	HG-008-0-XX004- ABAA-Y216-BB-S035	LEMO
8	35 MPa - NF* Breakaway coupling	-	9/16-18 UNF-2B with sealing cone 37°	21	115 / 127	340	35 / 43,8	1,9	229919	HG-008-0-XX008- ACAA-Y216-BB-S035	LEMO
8	35 MPa - NF* Breakaway coupling	-	7/16-20 UNF-2B with sealing cone 37°	21	115 / 127	340	35 / 43,8	1,9	238825	HG-008-0-XX011- ACAA-Y216-BB-S035	LEMO
8	35 MPa - HF* Breakaway coupling	-	9/16-18 UNF-2B with sealing cone 37°	21	115 / 127	340	35 / 43,8	1,9	229938	HG-008-0-XX008- ACAA-Y216-BB-THF-S035	LEMO
8	35 MPa - HF* Breakaway coupling	-	3/4-16 UNF-2B with sealing cone 37°-	21	115 / 127	340	35 / 43,8	1,9	238826	HG-008-0-XX013- ACAA-Y216-BB-THF-S035	LEMO

* NF = Normal flow / HF = High flow



Product Chart Breakaway Coupling (Nozzle side)

NB	Product type	A	A ₁	SW ₁ [mm]	D / D ₁ [mm]	L ₃ [mm]	Nominal / maximal- pressure [MPa]	Weight [kg]	ID	Part number	Cable
8	70 MPa - NF* Breakaway Nipple	M40 x 1,5 (female)	9/16-18 UNF-2B with sealing cone 60°	21	115 / 127	190	70 / 87,5	2,9	229924	HG-008-2-XX002- ACAB-Y216-BB- S070	LEMO
8	35 MPa - NF* Breakaway Nipple	M40 x 1,5 (female)	9/16-18 UNF-2Bs with sealing cone 60°	21	115 / 127	190	35 / 43,8	2,9	227755	HG-008-2-XX002- ABAB-Y216-BB- S035	LEMO
8	35 MPa - NF* Breakaway Nipple	M40 x 1,5 (female)	9/16-18 UNF-2B with sealing cone 37°	21	115 / 127	190	35 / 43,8	2,9	229920	HG-008-2-XX007- ACAA-Y216-BB- S035	LEMO
8	35 MPa - NF* Breakaway Nipple	M40 x 1,5 (female)	7/16-20 UNF-2B with sealing cone 37°	21	115 / 127	190	35 / 43,8	2,9	238828	HG-008-2-XX010- ACAA-Y216-BB- S035	LEMO
8	35 MPa - HF* Breakaway Nipple	M40 x 1,5 (female)	9/16-18 UNF-2B with sealing cone 37°	21	115 / 127	190	35 / 43,8	2,9	229939	HG-008-2-XX007- ACAA-Y216-BB- THF-S035	LEMO
8	35 MPa - HF* Breakaway Nipple	M40 x 1,5 (female)	3/4-16 UNF-2B with sealing cone 37°	21	115 / 127	190	35 / 43,8	2,9	238829	HG-008-2-XX012- ACAA-Y216-BB- THF-S035	LEMO

* NF = Normal flow / HF = High flow



Parking Station / Holster Series HG



Characteristics:

- Integrated connection for purging system with dry air
- High operating comfort and safe locking system
- Robust mechanical actuation to detect the correct parking of the refueling nozzle
- Reliable protection of the refueling nozzle with front-side sealing
- Multiple mounting angles possible

Benefits:

- Natural freezing of the refueling nozzle prevented
- Incorrect usage excluded, damages avoided
- Simple installation of proximity switch by customer
- Low service costs, penetration of air, water or other-pollution prevented
- Adaptable design of the dispenser



Parking Station / Holster Series HG

Feature chart | Parking station

Technical features	Construction / Materials	Options
<ul style="list-style-type: none"> End connection BSPP 1/4 female thread as interface to connect gas with nitrogen or dry air supply Mounting plate provided for easy assembly Multiple mounting angles Suitable both for 35 MPa - 70 MPa WALTHER refueling nozzles <p>Remark: Actuator for refueling nozzle detection provided by customer</p>	<p>Material Stainless steel, POM-C, black</p> <p>Seals FKM</p>	<p>Material Aluminium, in colours of choice</p>

Parking station with stainless steel plate housing

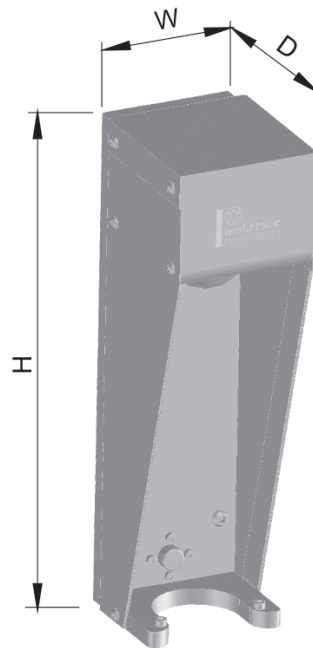

Product chart | Parking station

Product type	A (not shown)	W [mm]	H [mm]	D [mm]	ID	Part number
Parking station 35 MPa - NF	BSPP 1/4 for gas supply	92	306	109	227963	HG-004-B-00006-AAAV-Y14
Parking station 35 MPa - HF	BSPP 1/4 for gas supply	92	306	109	227963	HG-004-B-00006-AAAV-Y14
Parking station 70 MPa - NF	BSPP 1/4 for gas supply	92	306	109	227963	HG-004-B-00006-AAAV-Y14

* NF = Normal flow / HF = High flow



Hose Set Series HG

Feature chart | Hose set



- Description:**
- 70 MPa hose set, L = 4,000 mm, for the connection of refueling nozzle with breakaway coupling
 - High pressure hose with stainless steel wire reinforcement
 - Protection hose pricked to allow drainage of condensation water
 - Protection hose electrically conductive
 - Protection hose made of high-quality PUR

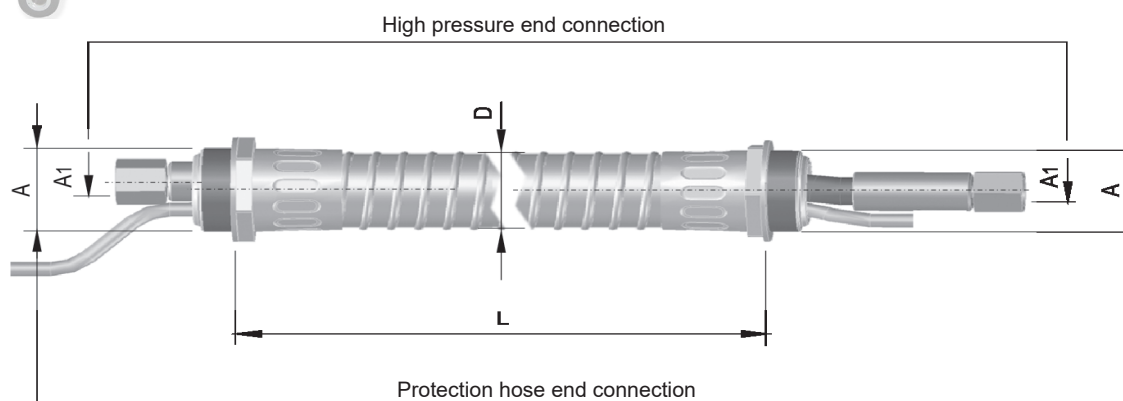

Product chart | Hose set

NB	Product type	A	A1	Cable	L [mm]	D [mm]	Weight [kg]	ID	Part number
4	Hose set with IR cable 70 MPa - NF*	M40 x 1,5	High pressure hose: (Spir Star)** 9/16-18 UNF M-Swivel*	Escha 5 wasy double sided with M12 E Plug/emergency seperation plug	4000	ca.40	k.A.	121137	95721-B-00007-AAAC-BB
4	Hose set with IR cable 70 MPa - NF*	M40 x 1,5	High pressure hose: (Spir Star)** 9/16-18 UNF M-Swivel*	LEMO 5 wasy double sided with M12 E Plug/emergency seperation plug	4000	ca.40	k.A.	237764	HG-004-B-00018-SBBA-Y116-S070
4	Hose set without IR cable 70 MPa - NF*	M40 x 1,5	High pressure hose: (Spir Star)** 9/16-18 UNF M-Swivel*	without cable	4000	ca.40	k.A.	141099	95721-B-00008-AAAD-BB
4	Hose set with IR cable 70 MPa - NF*	M40 x 1,5	High pressure hose: (Parker)** 9/16-18 UNF M-Swivel*	Escha 5 wasy double sided with M12 E Plug/emergency seperation plug	4000	ca.40	k.A.	223031	95721-B-00011-AAAG-BB
4	Hose set with IR cable 70 MPa - NF*	M40 x 1,5	High pressure hose: (Parker)** 9/16-18 UNF M-Swivel*	LEMO 5 wasy double sided with M12 E Plug/emergency seperation plug	4000	ca.40	k.A.	237766	HG-004-B-00018-SBBB-Y156-S070
4	Hose set without IR cable 70 MPa - NF*	M40 x 1,5	High pressure hose: (Parker)** 9/16-18 UNF M-Swivel*	without cable	4000	ca.40	k.A.	238277	HG-004-B-00021-SBBD-Y136-S070

* NF = Normal flow / HF = High flow | **Included in scope of delivery, other lengths on request



Special Tools Series HG

Feature chart | Venting tool



Description:

- Safe ventilation of breakaway coupling (car / nozzle side) after an emergency separation
- Easy to operate

Material: Stainless steel, bronze

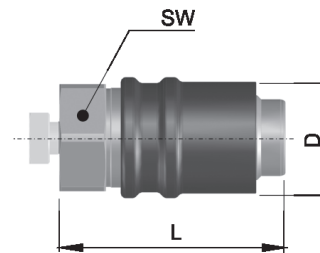

Product chart | Venting tool

NB	Product type	L [mm]	D [mm]	SW [mm]	ID	Part number
8	Venting tool	97,5	52	46	227964	HG-008-9-00002-AAAZ-Y216

Feature chart | IR exchange tool

Description:

- For changing the IR device

Material: Stainless steel

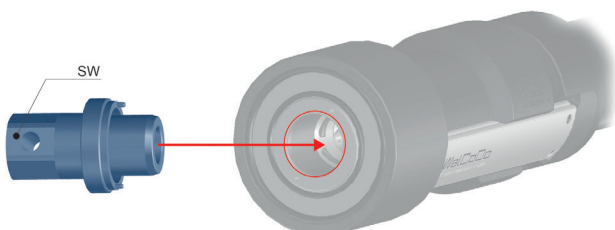

Product chart | IR exchange tool

Product type	SW [mm]	ID	Part number
IR exchange tool	24	214864	HG-004-550-0GAA-Y18



Refueling Receptacle Series HG

Feature chart | Receptacle



- Description:**
- Suitable for Ultra-coldfill until -40°C gas temperature
 - Interfaces to the vehicle for bulkhead 2 - 4 mm and reception IR module (car side)
 - Available with different high pressure end connections
 - Tested quality according to:
 - TRANS/WP.29/GRPE/2004/3 Part 1 resp. EIHP 12B
 - SAE J2600 - 70 MPa
 - Manufactured according to DIN EN 10204-3.1
 - Dust cap made of PUR included

Material: Stainless steel

Receptacle acc. to. SAE J2600 - 70 MPa

High pressure end connection

Car side

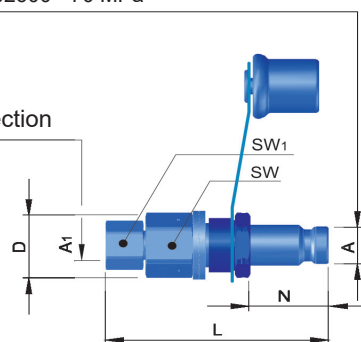

Supply side

Product chart | Receptacle

NB	Product type	A [mm]	A ₁	SW [mm]	SW ₁ [mm]	D [mm]	L [mm]	N [mm]	ID No.	Part number
4	Refueling receptacle 70 MPa - NF*	23	9/16-18 UNF 2B (inner thread)	36	32	42	121	40	98432	HG-004-9-SA514-AAAL-Y07-BB

* NF = Normal flow / HF = High flow



Description of the Refueling Process

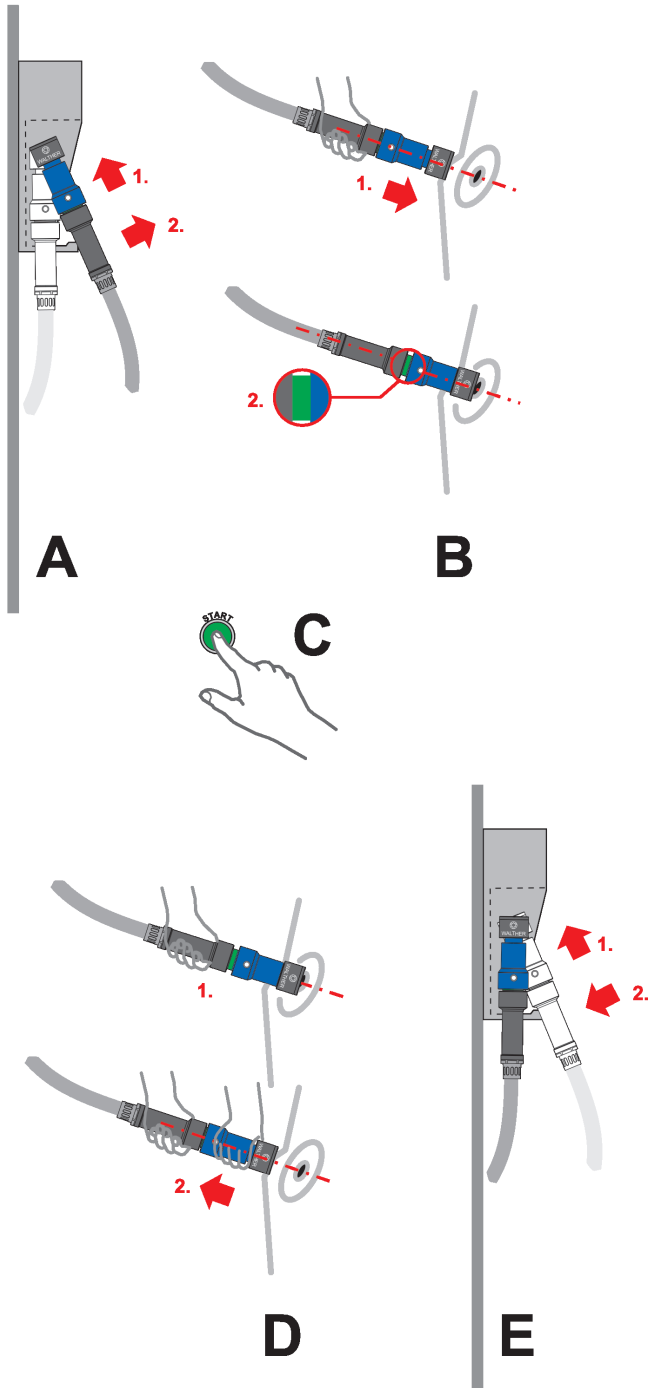

Step A - Start refueling process

1. Hold on to the black grip and push the Refueling Nozzle upwards.
2. Remove the Refueling Nozzle out of the Parking Station / Holster.

Step B - Engage nozzle with receptacle

1. To connect push the Refueling Nozzle straight onto the Receptacle.
2. A green ring signals a successful locking. The Refueling Nozzle is ready for refueling the fuel cell car!

Step C - Start refueling

Start the refueling process at the dispenser and wait 3-5 minutes to fully load

Step D - Disengage Refueling Nozzle from Receptable

1. Hold on to the black grip.
2. Pull the blue sleeve backwards over the green ring with the free hand.

Step E - Finish refueling process

1. Push the Refueling Nozzle upwards to the Parking Station/Holster counterpart.
2. Push the Refueling Nozzle into the locking mechanism inside the holster and double check that the nozzle is placed correctly.

The refueling process has finished successfully!



Worldwide in Operation for Our Customers

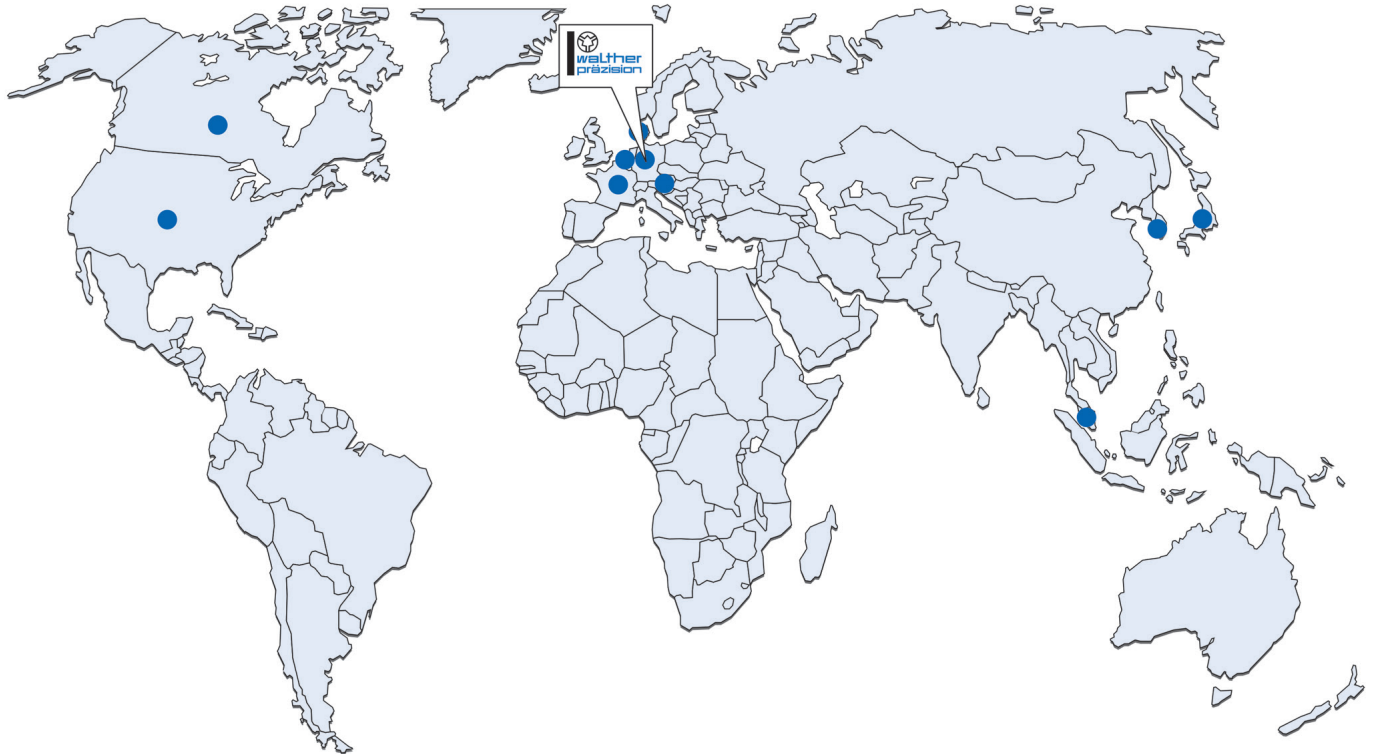

Head office: Haan | North Rhine-Westphalia | Germany



Safety Instructions and Liability



Liability

WALTHER-PRÄZISION assumes no liability and makes no guarantees for the completeness, accuracy and topicality of the information made available in its print media, Internet presence and operating manuals. All specifications in the catalogue are subject to change. Changes and errors excepted. The same applies to images.

Due to the different working modes and the versatile applications of quick coupling systems, WALTHER-PRÄZISION cannot guarantee with its dealership network that a particular quick coupling system is suitable for each specific application. Not all technical details to be considered during the selection of a quick coupling system are analysed. The user is personally responsible for the following after conducting their own analyses.

- For the safe operation and the observance of maintenance and servicing.
- The selection of their quick coupling system.
- Meeting the end user requirements.
- The safety precautions that are necessary during the use of quick coupling systems to prevent personal injury and property damage.
- Independent technical alterations.

Safety Instructions

Our extensive safety instructions can be found on our website under „Service“ or by using the provided QR code.



Pressure Equipment Directive

In accordance with the Pressure Equipment Directive 2014/68/EU of the European Union the series HG is classified as pressure-maintaining component. The member of the series HG (excluding hose, tools and accessory) are in conformance to the classification of the Pressure Equipment Directive and are delivered with CE marking.

WALTHER-PRÄZISION

Schnellkupplungssysteme / Quick Coupling Systems

Carl Kurt Walther GmbH & Co. KG

Hausadresse / Head office:

Westfalenstrasse 2
42781 Haan, Germany

T +49 (0) 2129 / 567-0
F +49 (0) 2129 / 567-450

Postadresse / Postal address:

PF / P.O. Box 420444
42404 Haan, Germany

W www.walther-praezision.de
E info@walther-praezision.de

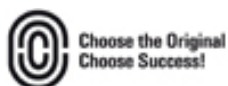

WalCoDo[®]
WALTHER CONNECTING & DOCKING