

ENGINEERING  
YOUR SPRAY SOLUTION



➤➤ AIR QUALITY  
CONTROL SYSTEMS  
for waste-to-energy plants

AIR QUALITY CONTROL SYSTEMS





# ENVIRONMENTAL SOLUTIONS FOR WASTE-TO-ENERGY PLANTS FROM EUROPE'S NO. 1 IN NOZZLE TECHNOLOGY

**For over 140 years, we have pioneered numerous groundbreaking developments in the field of nozzle technology. For this, we combine our comprehensive know-how in the field of nozzle engineering with an in-depth understanding of process and plant requirements. This means that we can provide solutions for the important challenges of waste-to-energy plants, such as:**

- Emission reduction (NO<sub>x</sub>, SO<sub>x</sub>, fine dust)
- Cost reduction through energy-optimized processes
- Adapted plant technology with customized solutions

## The temperature in the market is rising

For some years now, thermal waste treatment has been confronted with a whole series of complex challenges. In Europe, increasing recycling rates are leading to a general reduction of waste. Additionally, other industries such as the cement industry are showing increasing interest in secondary fuels. While at the same time, temporary environmental influences are increasing waste volumes, e.g. bulky waste due to pandemics or natural disasters. So while demand for incineration capacity is fluctuating, the existing plants still have to be operated economically.

On the other hand, the industry is a global growing market, with new waste incineration plants being built with a particular focus on Asian countries. Furthermore, ever stricter emissions directives are creating constant pressure to invest and innovate.

The answer to these challenges lies in more economical processes. Modern, high-performance gas treatment offers a variety of approaches for reducing costs while increasing efficiency. A prerequisite is that the upstream and downstream processes are thoroughly understood and the gas treatment is coordinated accordingly.

## We are on fire for thermal waste utilization

Our wide range of nozzles and gas treatment systems provides a solid basis for every application.

We work together with you to develop the optimum solution for your application. From beginning until end we will support you with comprehensive consulting services ranging from process analysis to turnkey solutions.

## Much more than just nozzles

At Lechler, we know the processes and requirements in waste-to-energy plants. In addition, we can simulate gas treatment and spraying processes using Computational Fluid Dynamics (CFD). Different parameters can be simulated and optimized. The end result is a model that exactly reflects your on-site conditions, but significantly increases efficiency by using optimized injection points and suitable nozzles.

That the solution actually works as calculated is checked in our own measurement laboratory. We verify the solution by simulating and calculating it in our own measurement laboratory. There, the individual nozzles and system solutions developed have to prove themselves on state-of-the-art test rigs.

# COMPETENCE – THE ADVANTAGE OF MULTIPLE PERSPECTIVES

## Worldwide presence

To provide you with local support, we are represented all around the globe – with locations in the USA, Great Britain, India, China, ASEAN, France, Belgium, Italy, Finland, Hungary, Spain and Sweden, as well as sales partners in almost every country.

Thanks to our decades of experience in many different industrial sectors, we approach your challenges by viewing the overall process rather than just the individual steps. We will gladly advise you on this.

### OUR PRODUCTS

### CUSTOMER ADVANTAGES



Wide product range



Service



Experience



Customer-specific solutions



Process optimization



Process reliability



Process guarantee



Cost savings

## CONTENTS

<b>Overview of Lechler applications in waste-to-energy plants</b>	<b>4</b>
<b>Choosing the right nozzle</b>	<b>6</b>
<i>VarioJet</i> nozzles	8
Laval nozzles	10
Special twin-fluid nozzles	12
1SR nozzles	13
Spillback nozzles	14
Standard nozzles	15
Nozzle lances	16
<i>VarioCool</i> and <i>VarioClean</i> systems	18
Option packages for our <i>VarioCool</i> and <i>VarioClean</i> systems	19
Lechler Online Cleaning (LOC)	22
TwinAbsorbPRO	24
TwinAbsorb	26
Additional services and products	27
<b>Droplet separator systems</b>	<b>28</b>
<b>CFD Analysis</b>	<b>32</b>
<b>Measuring technology</b>	<b>34</b>
<b>Engineering and service</b>	<b>35</b>

# OVERVIEW OF LECHLER APPLICATIONS IN WASTE-TO-ENERGY PLANTS

## LECHLER PRODUCT PORTFOLIO



Nozzles



Nozzle lances



Valve skid units



Droplet separators

### DeNOx SNCR

Laval or *VarioJet* twin-fluid nozzle lances spray fine droplets of aqueous ammonia for non-catalytic reduction of NOx.

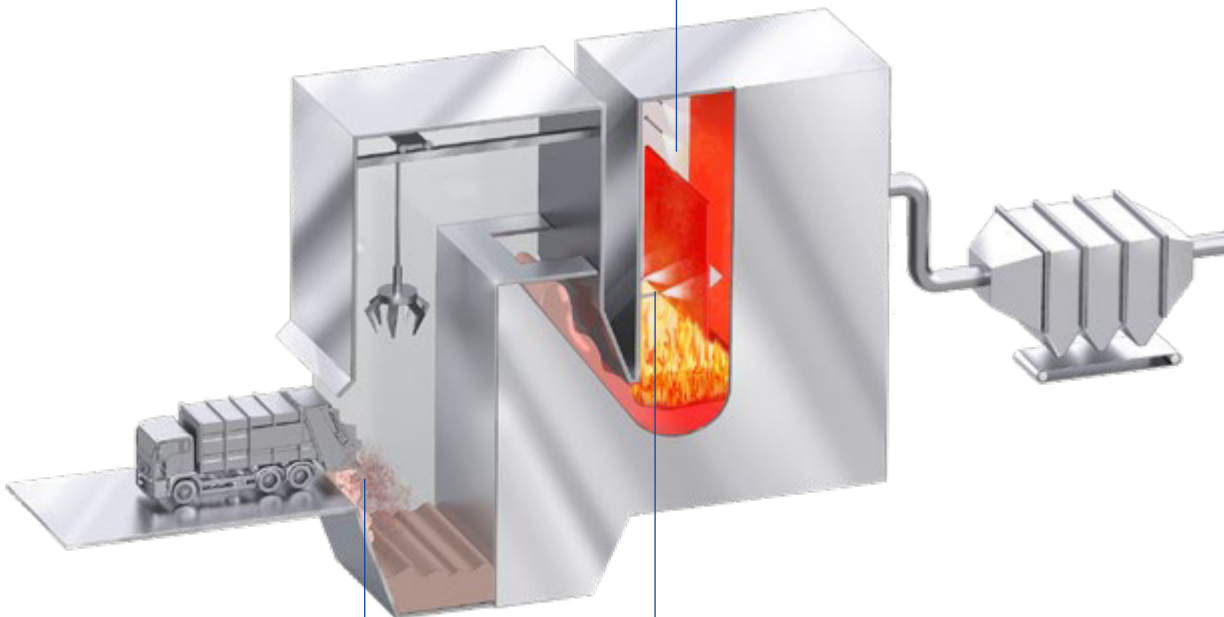

### Dust suppression

Injection with cluster head nozzles to significantly reduce dust turbulence during unloading and handling.

### Waste bunker drain

Disposal of highly corrosive water collected in the waste bunker by atomization with Laval or 1SR twin-fluid nozzle lances.

## DeSOx wet process

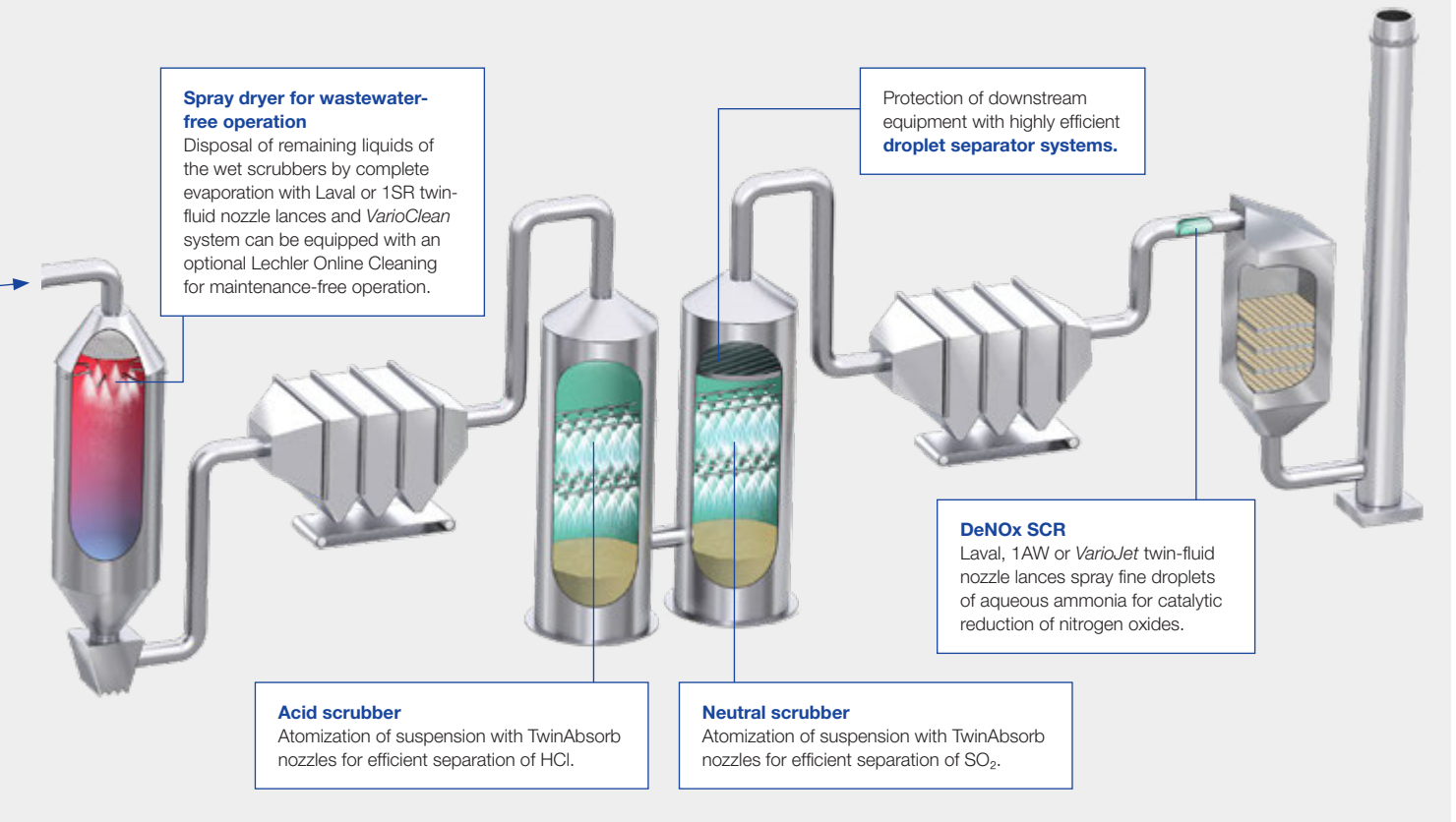

## DeSOx conditioned dry processes

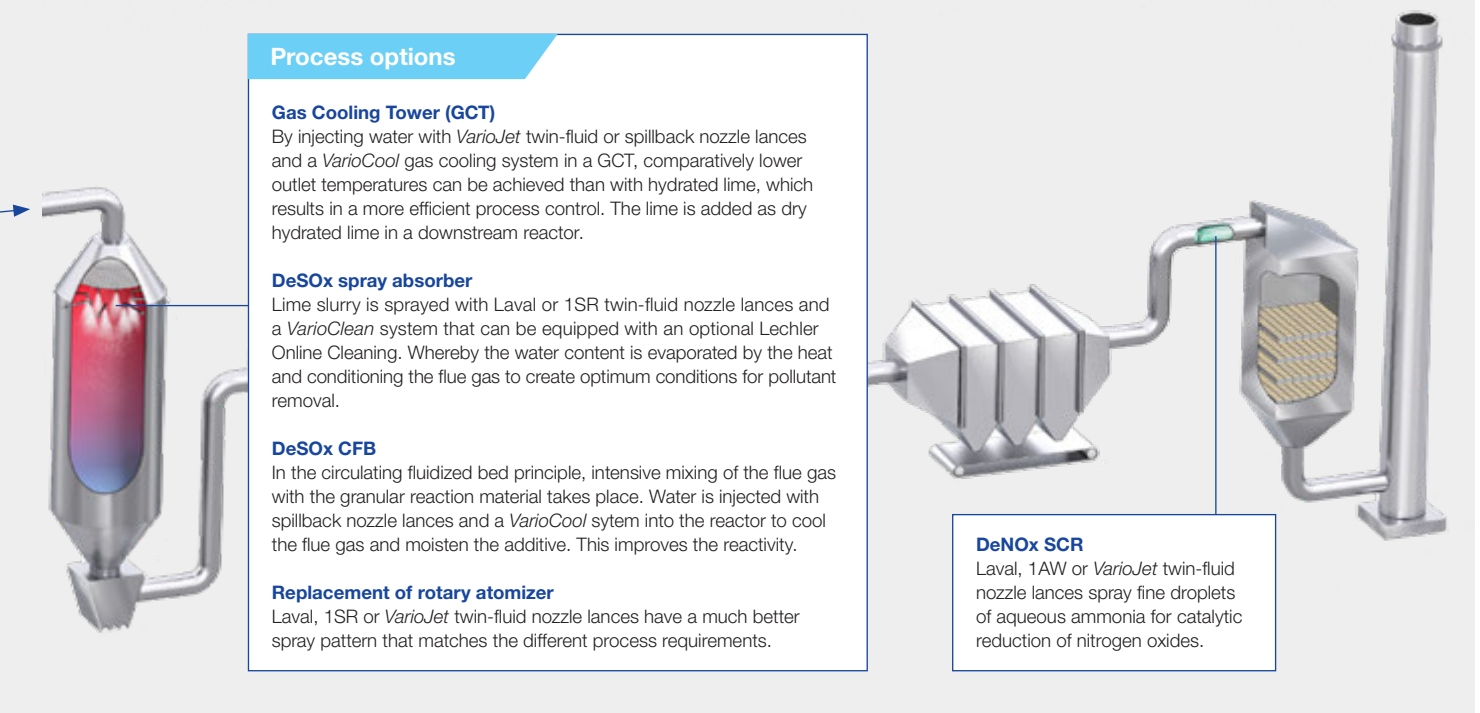

# ➤➤ CHOOSING THE RIGHT NOZZLE

Best results are achieved in gas cooling and conditioning processes only when detailed knowledge of process-specific requirements is available to assist in the choice of nozzles.

**We will provide you with comprehensive advice taking your system and the applications you require into account.**







## VarioJet nozzles

# Twin-fluid nozzles with low air consumption despite large outlet angle

**Lechler VarioJet nozzles** atomize according to the principle of internal mixing.

With this twin-fluid nozzle, the water is fed in axially via a bore hole. The liquid is split up into a thin liquid film. This thin liquid film is split into finest droplets by the atomizing air within the mixing chamber. The resulting two-phase mixture is then atomized a second time when exiting through several bore holes arranged in a circular fashion.

The spray is characterized by a large outlet angle with an even liquid distribution and a low air consumption. The fineness of the droplet spectrum is directly influenced by the air/liquid ratio and by the pressure level of the two flow rates. As a general rule: the higher the air/liquid ratio and the higher the pressure level of atomizing air and liquid is, the finer the droplet spectrum.

The large free cross-sections in the nozzle keep the risk of clogging and the maintenance effort to a minimum.



### Properties:



#### Large spray angle

(60°, 90°) for good coverage of the cross-section of the duct



#### High turn-down ratio

up to 20 : 1



#### Adjustment of the droplet spectrum

by changing the air/fluid ratio



#### Clog-resistant

thanks to large free cross-sections without internal fittings



#### Low air consumption



#### Typical pressure range

Liquid 1–9 bar, g  
Atomizing air 1–6 bar, g

### Use

- Gas cooling in all sizes of evaporative coolers
- Injection of aqueous ammonia or urea solution for the DeNOx process (SNCR/SCR)



## VarioJet nozzle

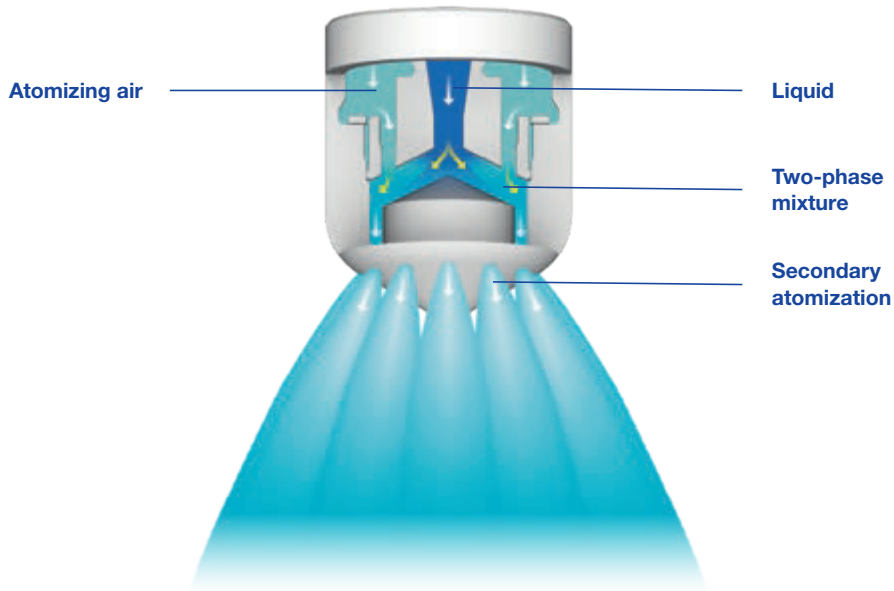

## Variable control concepts of twin-fluid nozzles

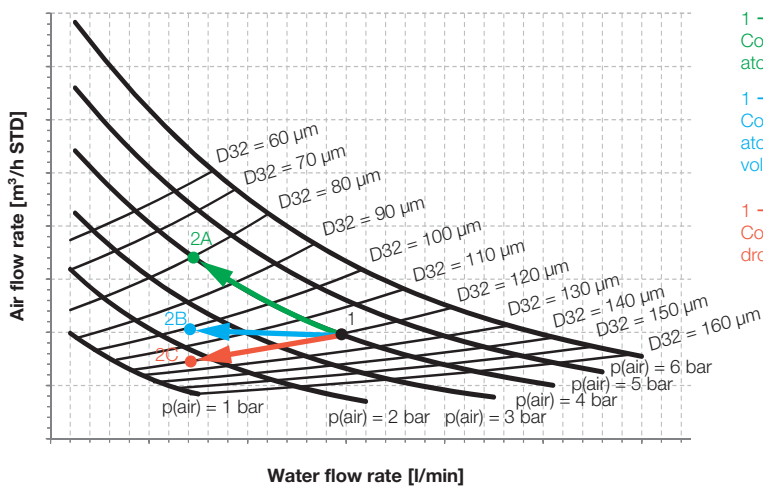

- 1 → 2A  
Constant  
atomizer air pressure
- 1 → 2B  
Constant  
atomizer air  
volume flow
- 1 → 2C  
Constant  
droplet diameter



Spray pattern of the VarioJet nozzle



# Laval nozzles

## Twin-fluid nozzles for a wide droplet spectrum in special applications

**Lechler Laval nozzles** atomize liquids as a fine full cone.

A two-phase mixture is created from atomizing air and liquid in the mixing chamber inside the nozzle. The shape of the nozzle causes this mixture to be accelerated to supersonic speed, resulting in an extremely fine atomization of the droplets.

By changing the air/liquid ratio, the droplet size and the droplet spectrum can be adapted within a wide range. The large free cross-sections of the nozzle also allow atomization of viscous or solids-laden liquids.

Choosing the right material prevents wear even where abrasive media are present, and enables use at high temperatures.



### Properties:



#### Small spray angle

(15°), suitable for small cross-sections and horizontal ducts



#### Very large turn-down ratio

of 20 : 1 (in some cases up to 40 : 1)



#### Adjustment of the droplet spectrum

by changing the air/fluid ratio



#### Clog-resistant

thanks to large free cross-sections without internal fittings



#### Very fine droplet spectrum



#### Typical pressure range

Liquid 1–6 bar, g  
Atomizing air 1–6 bar, g

### Use

- Gas cooling in gas-bearing pipes (ducts) and small gas cooling towers
- Injection of solids-laden water
- Injection of lime slurry in the desulfurization process
- Injection of aqueous ammonia or urea solution for the DeNOx process (SNCR/SCR)
- Chemical process engineering (spray dryers etc.)
- Spray dry evaporation of wastewater

## Laval nozzle

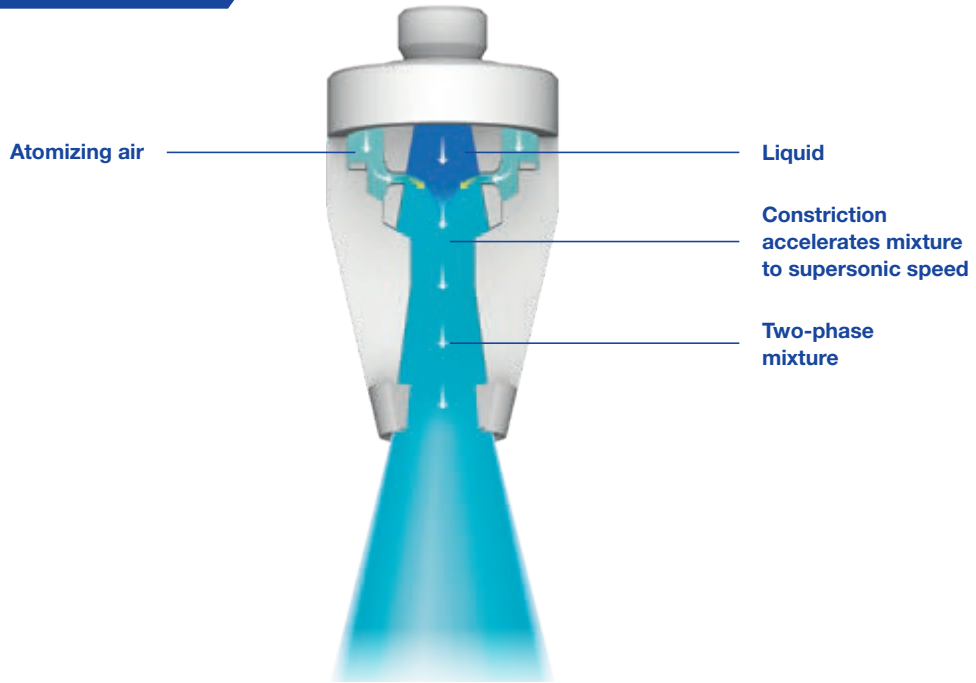

## Operating point of a twin-fluid nozzle

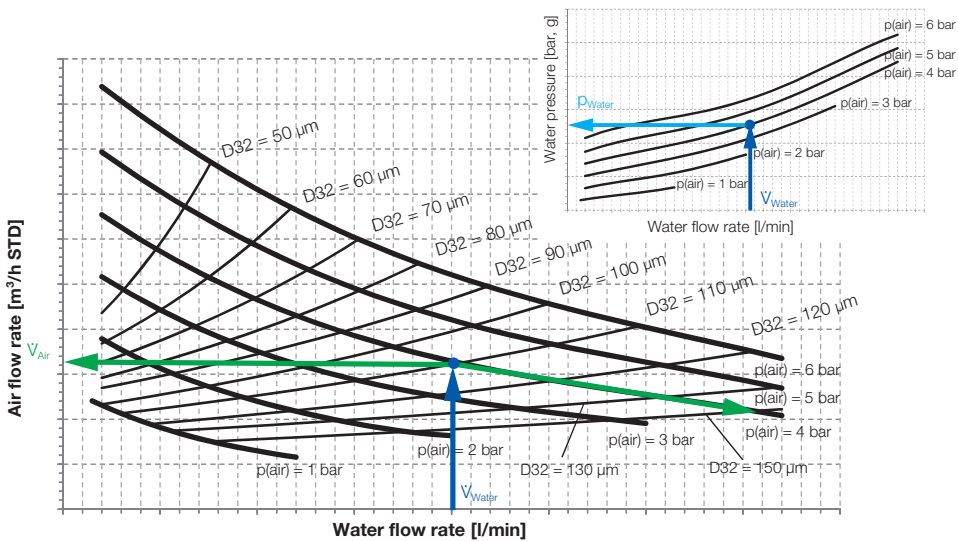

Spray pattern of the Laval nozzle

# Special twin-fluid nozzles for DeNOx applications

**The Lechler Laval flat fan nozzle** atomizes according to the principle of inside mixing. The air/fluid mixture exits via three outlet holes creating a wide and flat spray with an even better surface coverage.

The droplet spectrum and the pulse of the droplets can be adapted by changing the air/fluid ratio.

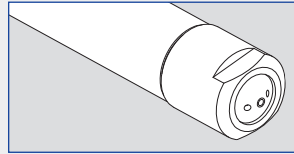

Spray pattern of a flat fan nozzle

## Special properties:



**Wide and flat jet,**  
spray angle 60°



**Adjustment of the droplet spectrum**  
by changing the air/fluid ratio



**Turn-down ratio**  
of over 10 : 1



**Spray alignment possible**



**Typical pressure range**  
Liquid 1–5 bar, g  
Atomizing air 1–5 bar, g

**The Lechler 1AW nozzle** works according to a newly developed and patented atomization principle. It divides the supplied atomizing air into a primary and secondary air flow. Thanks to the specific inflow geometry, the secondary air exits through an annular gap causing a very fine atomization in the edge region of the spray.

This twin-fluid nozzle enables finest droplet spectra and shortest evaporation distances while also allowing precise control of the flow rate. Cluster heads designed specifically for these nozzles multiply the flow rates and adapt the spray pattern to the requirements at the point of injection.

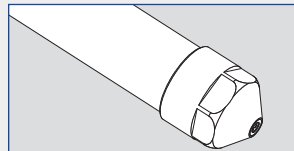

**Single nozzle without barrier air**  
Spray angle 15°; full cone



**Cluster head with three nozzles with barrier air**  
Spray width approx. 55°, spray depth approx. 15°; flat fan



Spray pattern of 1AW nozzles

## Special properties:



**Spray angle of the individual nozzle**  
15° as full cone



**Adjustment of the droplet spectrum**  
by changing the air/fluid ratio



**Particularly fine droplets**  
thanks to tertiary atomization



**Execution**  
as single or cluster nozzle lances possible



**Turn-down ratio**  
of 10 : 1



**Typical pressure range**  
Liquid 1–5 bar, g  
Atomizing air 1–5 bar, g



# 1SR nozzles

## Twin-fluid nozzles for spray dryer and spray absorber

The **Lechler 1SR** designed especially for the atomization of lime slurry and suspension is optimally matched to the requirements of the semi-dry flue gas cleaning process and the Lechler LOC systems.

The basic principle of this nozzle is equivalent to the Laval nozzle. This twin-fluid nozzle atomizes fluids as a fine full cone. In doing so, a two-phase mixture is generated on the inside of the nozzle from atomizing air and fluid (e.g. lime slurry). The further formation of the nozzle has the effect that this mixture is accelerated which leads to an extremely fine atomization of the droplets. Due to the ring gap air, the coarse droplets on the edge area of the spray jet are atomized to fine droplets by a secondary atomization.

By changing the air/liquid ratio, the droplet spectrum can be adjusted in a larger area.

The large free cross-section of the nozzle also permits the atomization of viscous fluids or fluids loaded with solid matters. The correct material selection reduces wear, also with abrasive media and permits use at higher temperatures.

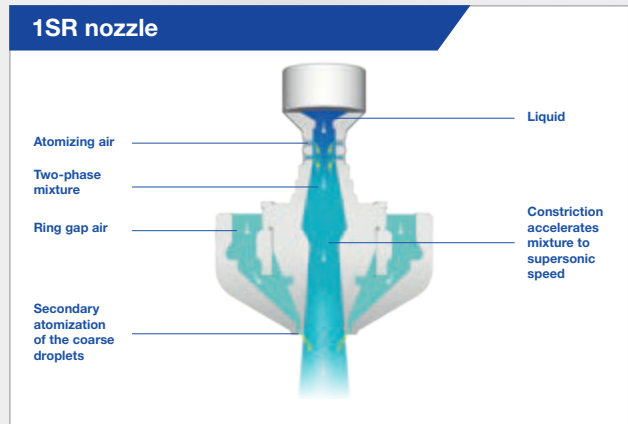

### Special properties:



**Small spray angle**  
15°



**High turn-down ratio**  
of 10 : 1



**Adjustment of the droplet spectrum**  
by changing the air/fluid ratio



**Clog-resistant**  
thanks to large free cross-sections without internal fittings



**Very fine droplet spectrum**  
by secondary atomization of the edge droplets by the ring gap air



**Typical pressure range**  
Liquid 1–6 bar, g  
Atomizing air 1–6 bar, g

### Use

- Injection of lime slurry in spray absorber
- Injection of process water in the spray dryer



# Spillback nozzles

## Atomization without compressed air

**Lechler spillback nozzles** atomize liquids as a fine hollow cone according to the pressure atomization principle. The water is sent to the nozzle with a relatively constant feed pressure, independent of the flow rate.

The amount of liquid injected is adjusted via a control valve in the spillback line. The maximum atomized flow rate is achieved with the control valve closed.

Uniform and fine liquid atomization is achieved across the entire control range.

The atomized flow rate can be distributed over cluster heads with up to six small nozzles.

The number of lances can be significantly reduced thanks to the total spray angle of about 120°.



### Properties:



**Spray angle of the individual nozzles**  
90° or 60° as hollow cone



**High turn-down ratio**  
up to 12 : 1



**Even and fine liquid atomization**  
over the entire control rang



**Execution**  
as single or cluster nozzle lances possible



**Low operating costs**  
as no atomizing air required



**Typical pressure range**  
of 35 bar, g in the supply line at the nozzle

### Spillback nozzle

Control valve in return line opened

Feed flow rate with constant feed pressure

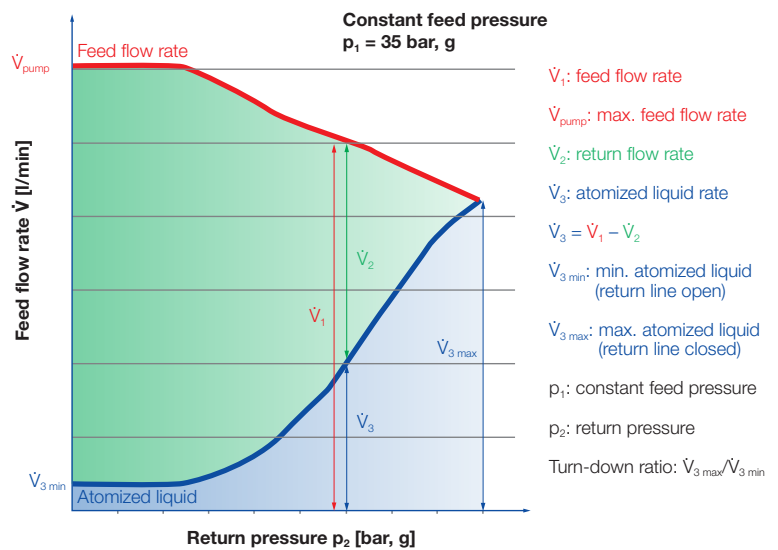
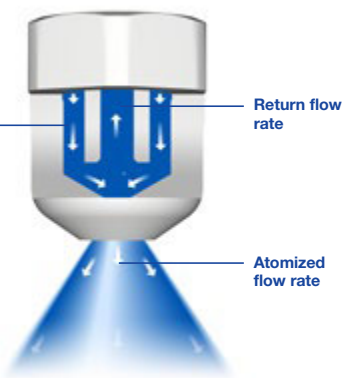

Spray pattern of a single spillback nozzle



Spray pattern of a cluster spillback nozzle lance

### Use

Gas cooling in medium-sized and large gas cooling towers.

## ➤ Standard nozzles for a wide range of applications

In addition to the described nozzles, Lechler offers a wide range of standard nozzles that have proven themselves many times over. They can be used in a wide variety of applications and are characterized by their uniform spray pattern even under difficult conditions.

**Lechler cluster head nozzles** achieve a very large surface of the sprayed liquid by adding various finely atomizing single nozzles. Whenever a fine fog-like full cone atomization with relatively large flow rates is necessary, e.g. gas exchange processes, steam cooling or dust suppression, Lechler cluster head nozzles have decisive advantages: overlapping hollow cones form a fine full cone atomization with an increased droplet surface area.



Spray pattern

### Series 502/503

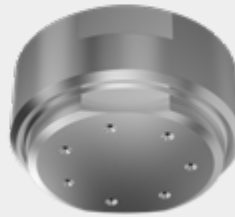

↔ 70°

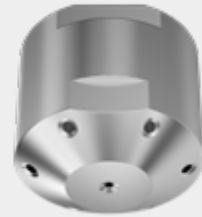

↔ 130°

#### Use

- Chlorine precipitation
- Absorption
- Dust suppression
- Degassing of liquids
- Desuperheating

### Axial-flow full cone nozzles

**Lechler full cone nozzles** have an extraordinarily uniform liquid distribution over the whole circular impact area. The high precision of distribution is achieved by orienting the liquid inlet to the center of the swirl chamber of the nozzle. The optimized x-style swirl insert ensures a high operating safety due to its large free cross-sections.



### Series 490/491

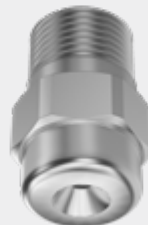

#### Use

- Cleaning and washing processes
- Surface spraying
- Chemical process engineering
- Foam control



# Nozzle lances

## Highest spraying accuracy in the flue gas duct

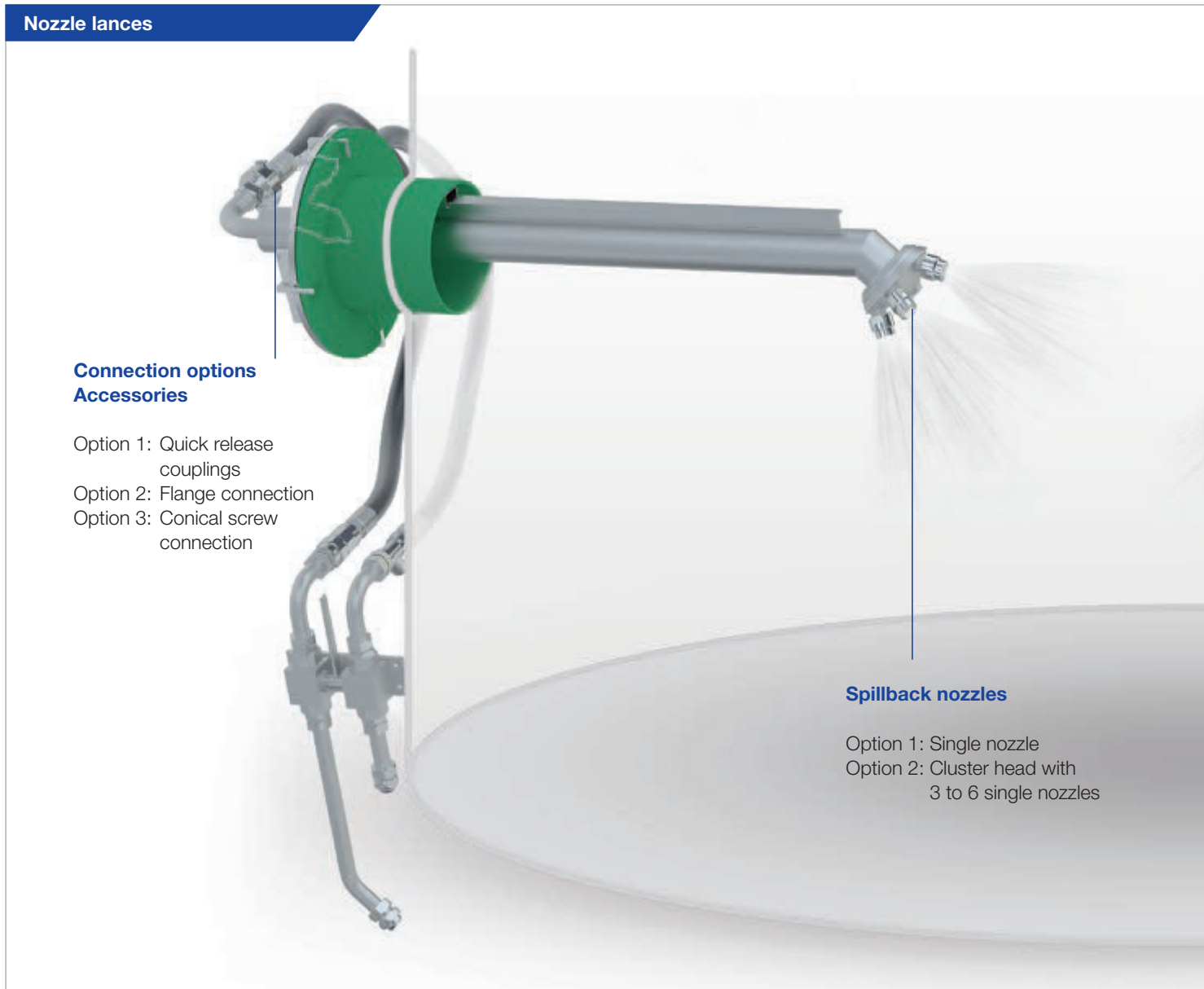

### Nozzle lances

#### Connection options Accessories

- Option 1: Quick release couplings
- Option 2: Flange connection
- Option 3: Conical screw connection

#### Spillback nozzles

- Option 1: Single nozzle
- Option 2: Cluster head with 3 to 6 single nozzles

**Lechler nozzle lances** ensure optimal spray placement and alignment in flue gas ducts. The nozzles themselves have a low-maintenance design and can be quickly cleaned or exchanged with minimal effort.

### The following lance options are available

- Protection tube to increase the service life in case of higher temperatures, high dust loads and aggressive gases, with barrier air as an option
- Wedge flange, standard flange and special flange in accordance with customer requirements
- Guide rail to facilitate lance installation
- Shifting device to change the insertion length – with or without gastight sealing
- Expansion joint or stuffing box for expansion compensation at high temperatures
- Mounting tube with flange connection for welding onto flue gas duct
- Special customizations such as wear protection, insulation, water cooling or coating also up to temperatures of 2,100 °C possible
- Pre-assembled accessory kits for process media connections (e.g. quick release couplings, shut-off ball valves, strainers)



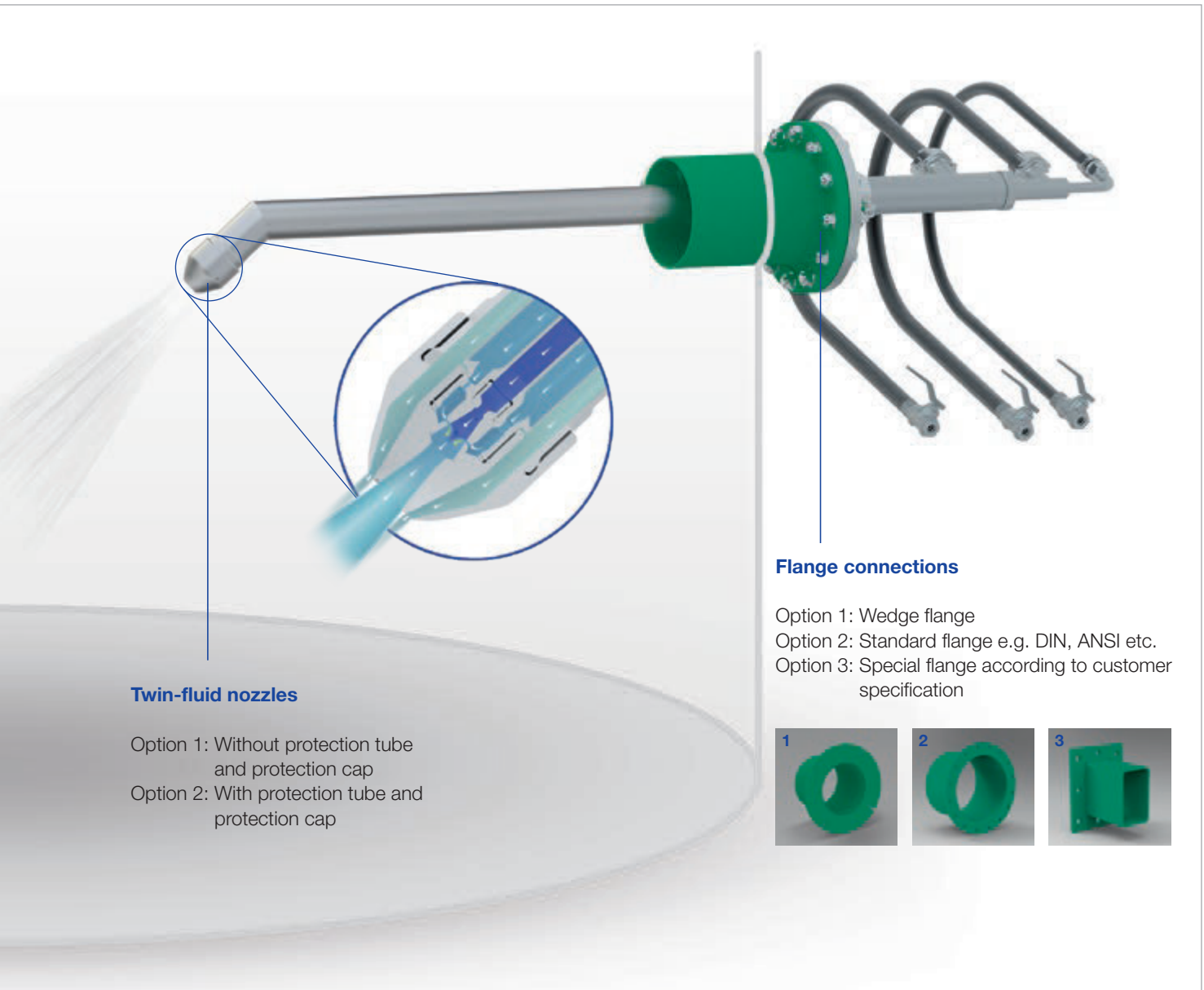

**Twin-fluid nozzles**

- Option 1: Without protection tube and protection cap
- Option 2: With protection tube and protection cap

**Flange connections**

- Option 1: Wedge flange
- Option 2: Standard flange e.g. DIN, ANSI etc.
- Option 3: Special flange according to customer specification



**Material**

Lances are manufactured from stainless steel (316/316L) as standard, but depending on requirements can also be made of chemical and high-temperature resistant materials. Accessories are available in galvanized steel or stainless steel and the hoses are available in rubber or stainless steel.



**Talk to us**

Each gas cooling tower and flue gas duct is different. Which is why standard solutions do not always make sense. Speak with us and let us work together to find the best solution for your purposes.



# VarioCool and VarioClean systems for a perfectly tailored solution

Our valve skid units for regulating the flow rates of liquid and atomizing air are individual customer-specific solutions. Based on the requirements in each case, our first step is to design an overall concept and select the best components in order to create a perfectly tailored solution.

## First-class engineering

To perform our engineering, we determine all relevant parameters and define the plant's design: This includes determining the nominal diameters and pressure levels as well as designing the pumps and control valves. We draw up the P&I diagram and make detailed equipment and signal lists as an option. Of course, the project is fully documented to ensure that technology and processes can be quickly traced even after years of use.

## High-quality components

The economic efficiency of a solution is determined to a large extent by the service life of the products used. Unexpected failures can quickly lead to plant stoppages and costly production outages. This is why our valve skid units are engineered with high-quality components from well-known manufacturers. The most important feature of our valve skids is the fail safe operation and redundant design of instrumentation and other key components.

The components are interconnected with pipes and mounted on a stable base frame with eyelets for crane transportation. This allows to reduce the assembly time on site to a minimum.

An exact knowledge of the characteristics of our nozzles is key. For only a complete system that is coordinated to the nozzles function and operation will ensure smooth and economical operation.

## Tested quality

The design (e.g. dimensioning of nominal diameters) and production are in line with the latest state of the art and comply with all relevant standards. They are equally subject to the Lechler quality management system certified to DIN EN ISO 9001, as is the final acceptance. Before delivery, the valve skid unit undergoes a pressure and tightness test.

## Control concept from the nozzle specialist

Numerous installations of *VarioCool* and *VarioClean* systems, years of commissioning experience, plus expertise in nozzle technology all contribute to the constant improvement and optimization of Lechler control systems. The flexible and fully automatic concept can be perfectly adapted to your process. You will have start-up and shut-down scenarios and dynamic process conditions under perfect control with our solution.

## ➤ Option packages for our *VarioCool* and *VarioClean* systems

### Electrical wiring of the components

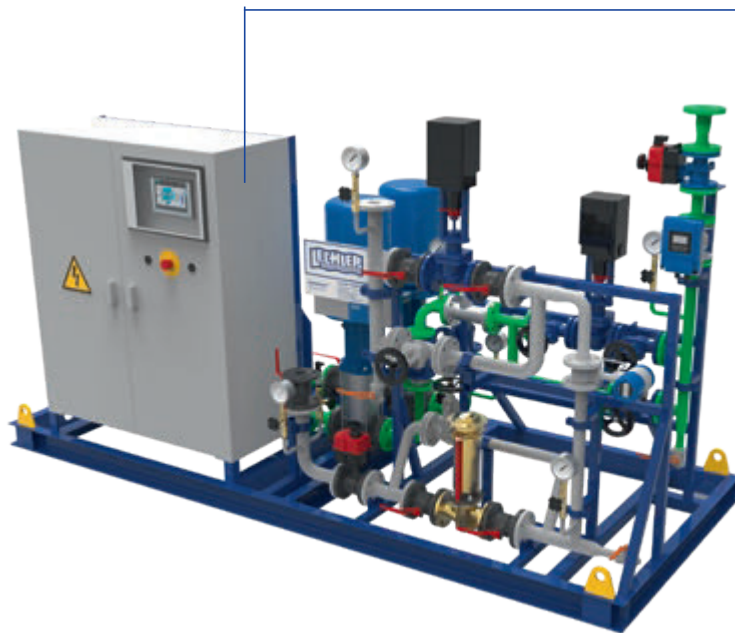

#### Control cabinet with complete PLC

All components including the pumps are wired to a control cabinet.

The complete injection control allows all relevant process parameters to be visualized over a control panel on the control cabinet.

Specific configuration and extensive testing make commissioning much faster. Communication and the exchange of signals (set-point, plant status, error messages) with the customer's logic system is carried out via PROFIBUS or PROFINET.

The control has several modes of operation such as automatic mode and manual mode for tests during plant downtimes.

In the event of faults, the installed modem allows quick remote diagnosis and minimizes possible downtimes.



#### Junction box

All components except the pump motors are wired to a junction box within the valve skid unit.

This assures that the customer has a central connection point for all electrical components and measuring devices for further processing in the higher-level control.



## Extended scope of delivery for our *VarioCool* and *VarioClean* systems

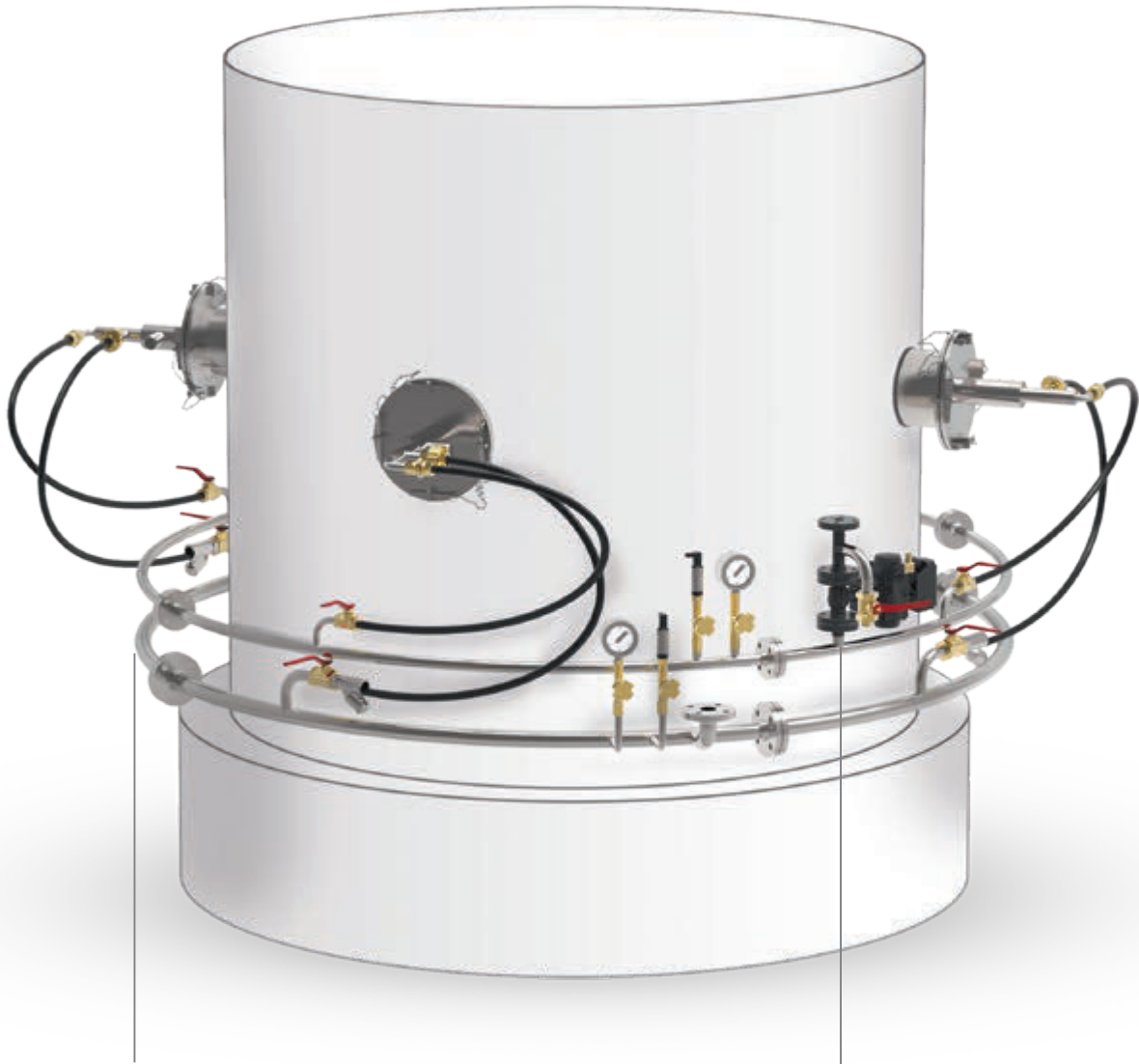

### Ring mains

Lechler supplies ring mains and headers together with the corresponding brackets for welding onto the flue gas duct. Accessories such as pressure transmitters and manometers plus the appropriate connections for the lances and supply lines are also included in the scope of delivery.

### Purge air connection

In order to increase the injection turn-down ratio, individual lances or lance groups can be connected or disconnected. If the disconnected lances are in the flue gas duct, the rest of the fluid should be purged. Vaporization and deposits in the lance can be prevented in this way.

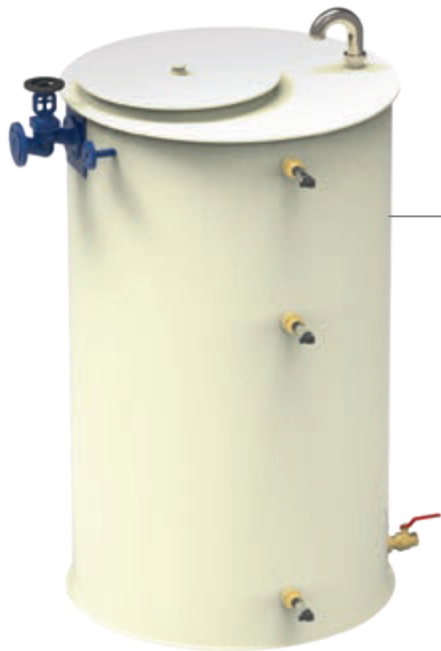

#### Water tank

A water tank made of steel or plastic serves as a reservoir for the valve skid unit and guarantees injection operation in the event of the water supply failing. Its size is adapted to the injection quantity. The components for tank filling and level monitoring are included in the scope of delivery.



#### Barrier air fan

In order to protect the nozzles and lances from dust deposits and/or high temperatures, barrier air is frequently applied to them. For this purpose, Lechler supplies fans geared to the specific application with various optional attachments such as a throttle valve, suction filter and silencer.

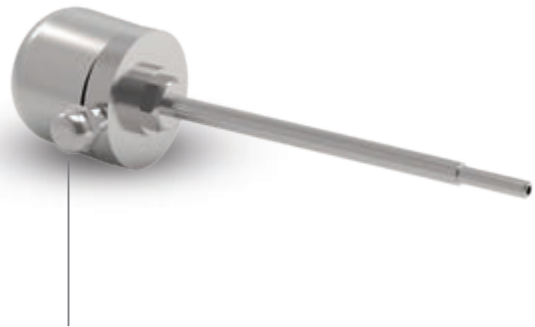

#### Temperature measurement

For a consistently regulated outlet temperature, it is very important for the response characteristics of the temperature sensors to be adapted to the ambient conditions. Lechler provides the appropriate thermometers and assists you in defining the installation.

#### Talk to us

Do you require an option that is not listed? Or are you having planning issues? No problem. Tell us what your requirements are. We will find the appropriate solution and ensure a seamless integration.



# Lechler Online Cleaning (LOC) Cleaning-in-Place system for twin-fluid nozzle lances

In the semi-dry flue gas cleaning processes a suspension, usually lime slurry, is injected into the hot flue gas in spray towers. The droplets injected by twin-fluid nozzles are evaporated by the transferred heat. At the same time, pollutants such as SO<sub>2</sub>, HCl and HF react with the reactants in the washing fluid.

The suspension frequently causes damaging deposits and blockages in the nozzles, nozzle lances and pipelines. In the past, reliable long-term plant installation was often not possible without regularly dismantling and cleaning the nozzle lances. Good process results frequently came at the cost of high maintenance effort.

**The Lechler LOC Cleaning-in-Place system eliminates the need for complex disassembly, unnecessary downtimes and personnel costs and permits reliable continuous operation.**

## Injection of wastewater

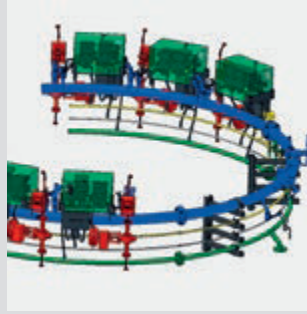

Ring mains with LOC unit



Installation at spray tower

## LOC makes your plant more economically efficient

Lechler offers an online cleaning system tailored to the respective application which allows reliable continuous operation and inexpensive cleaning of the nozzle lances. The nozzles are made of wear-resistant hard metal and have been optimized for atomizing suspensions. The individual lances are cleaned

cyclically during ongoing operation using precisely metered quantities of cleaning agents. In many cases, minimum use of diluted citric acid (10%) and compressed air is sufficient for reliable cleaning while at the same time ensuring compliance with the process limit values.

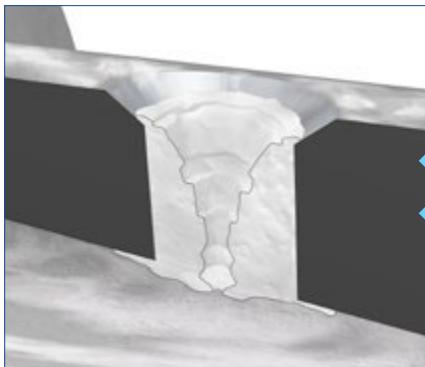

Blocked air holes

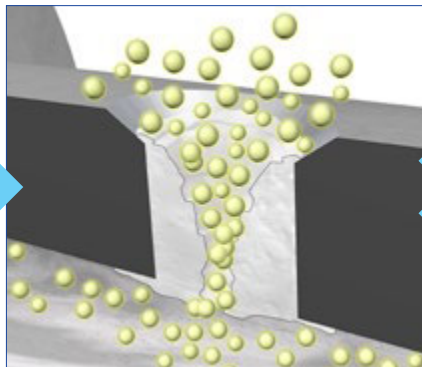

Cyclical cleaning with citric acid doped in compressed air

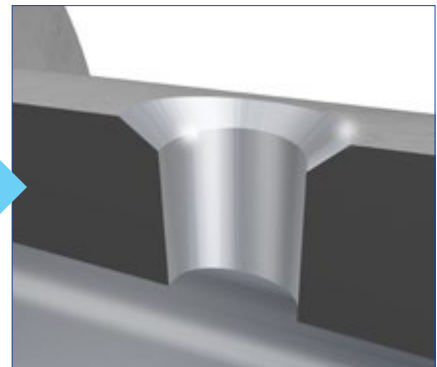

Cleaned nozzle

LOC reference installation  
with maximum equipment  
configuration

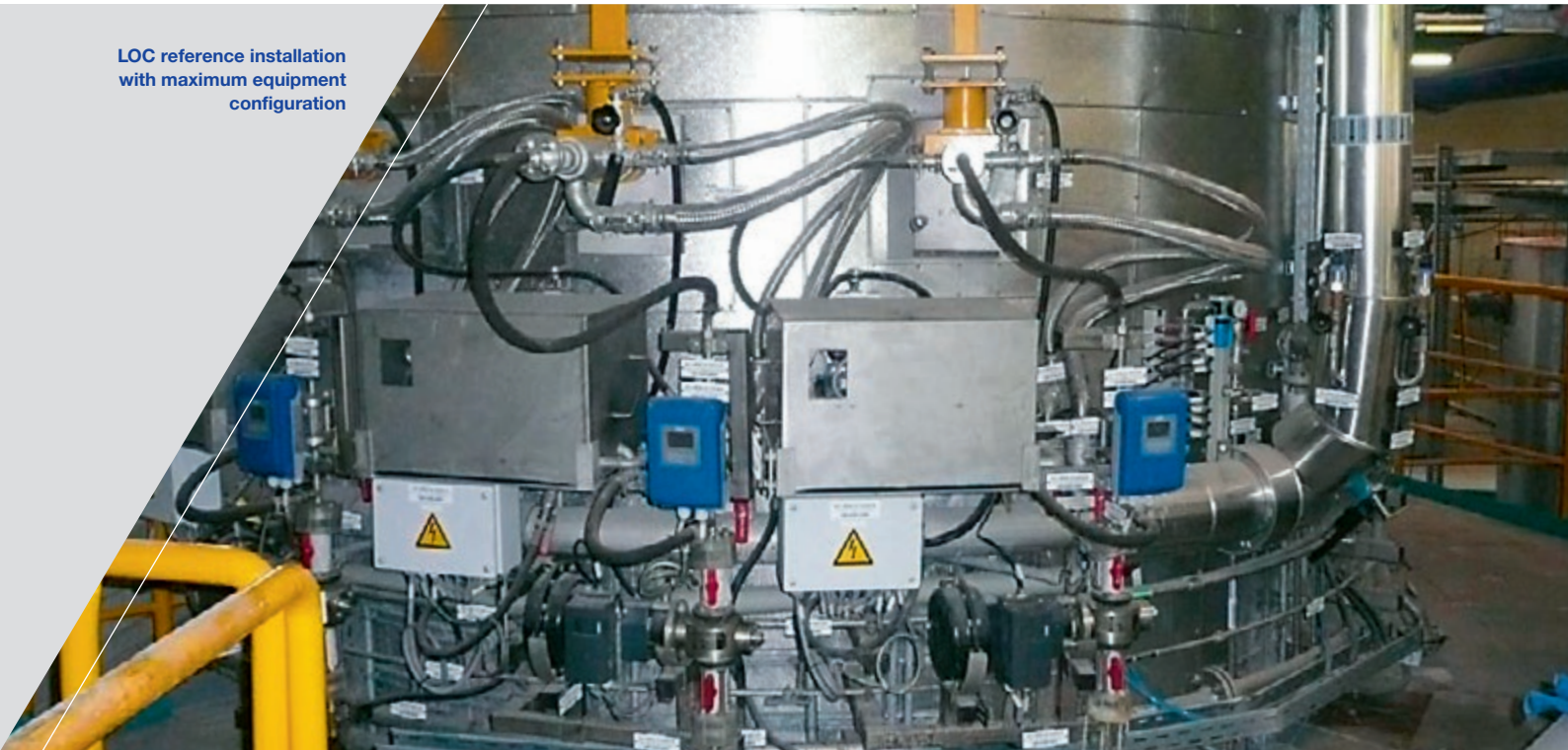

A visible difference: nozzles before and after LOC automatic cleaning

#### Advantages

- High availability of the spray reactor/dryer
- Uninterrupted operation
- Minimum maintenance effort
- Low costs through the controlled use of cleaning agents

#### Talk to us

Lechler Online Cleaning (LOC) is a tailor-made solution. The better we know your requirements and operating conditions, the more efficiently your processes will run. Let's talk to each other – about efficiency, cost savings and success.



# TwinAbsorbPRO

## The innovative scrubber nozzle that fits your needs

**NEW**



**Properties:**

- Adjustable spray angle in all directions
- Supports uniform gas distribution
- Non-circular spray pattern
- Improved mass transfer
- Optimized atomization
- Clogging insensitive

**Applications:**

- Flue gas cleaning



Equilateral



Bi-directional

The TwinAbsorbPRO (Lechler patented) provides non-circular spray patterns. Among other things, it can stimulate the desulfurization process through counter-rotating swirl and intensive secondary atomization. Higher differential velocities between gas and sprayed medium as well as stronger turbulence of the droplets correspondingly improved mass transfer in the scrubber. All this ensures that the largest possible reaction surface is permanently available for the absorption process.

### Protection of piping, installations and walls

The TwinAbsorbPRO series features an all-round adjustable hollow or full cone spray pattern. This allows nozzles close to the wall and piping to be adjusted. Therefore the spray cone follows the scrubber walls and piping gently, avoiding erosion and preventing the loss of reaction surface which will enhance the process.

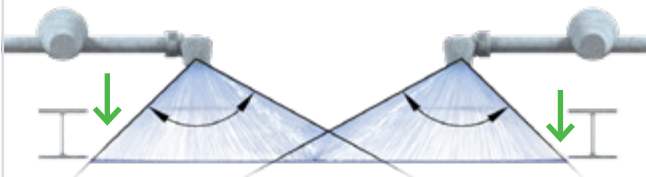

### Improved coverage

Thanks to the spray angles, which are adjustable in all directions, complete coverage of the interior can be achieved while protecting walls piping and internals.

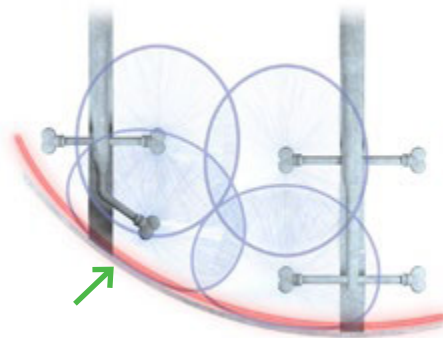

### Maintenance-free design

Due to self-draining design and the wide free cross sections, TwinAbsorbPRO is maintenance-friendly and allows continuous processes.

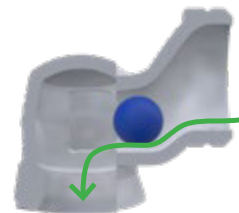

Experience  
TwinAbsorbPro  
live

Seeing is believing. Convince yourself of the technical advantages of TwinAbsorbPRO in the videos, which show the coverage of scrubber sections and protection of installations, walls and piping.

**Available TwinAbsorbPRO videos:**

- Efficient coverage of scrubber sections and protecting walls from wearing
- Efficient coverage of scrubber sections and protecting beams and installations from wearing
- Efficient coverage of scrubber sections and protecting piping from wearing





## The PROs of TwinAbsorbPRO

<b>PRO<sub>deSOx</sub>:</b>	Improved DeSO <sub>x</sub> due to higher availability, less liquid loss at wall and smaller drop size.
<b>PRO<sub>dedust</sub>:</b>	Consequently DeDusting can be improved. First plants operate already successful.
<b>PRO<sub>active</sub>:</b>	A 70:30 spray distribution enables exceptionally low pressure losses in the system.
<b>PRO<sub>ective</sub>:</b>	Less impact onto the wall protects rubber lining and others.
<b>PRO<sub>drain</sub>:</b>	Improved self-drain function.
<b>PRO<sub>availability</sub>:</b>	Less clogging compared to full cone nozzles due to largest free passages.
<b>PRO<sub>maintenance</sub>:</b>	Less replacements, less cleaning effort, higher availability, reliable operation of plant.

## Spray pattern

The spray angle of the TwinAbsorbPRO can be adjusted in all directions between 35 and 55°. Standard operating pressure is between 0.5 and 2 bar. Other design data are available upon request. The flow rate depends on the application. The connection to the piping is available as thread, flange, clamp, glue or laminate connection.

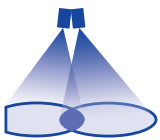

TwinAbsorbPRO  
Equilateral hollow  
cone nozzle



TwinAbsorbPRO  
Bi-directional  
hollow cone



TwinAbsorbPRO  
Equilateral  
full cone



TwinAbsorbPRO  
Bi-directional  
full cone

## Triple DeSO<sub>x</sub> benefits

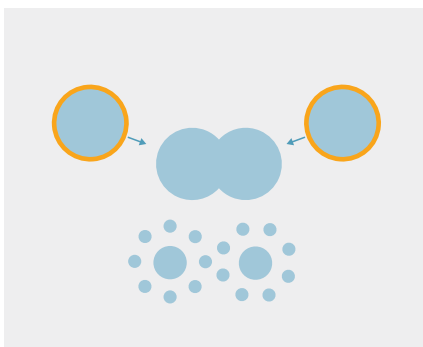

### Collision effects

The angled nozzle openings of a TwinAbsorb equilateral nozzle create two overlapping spray cones, which additionally intersect the neighboring spray cone within the same unit. The resulting collisions increase the specific surface area significantly and form a reactive droplet surface which is not yet saturated.

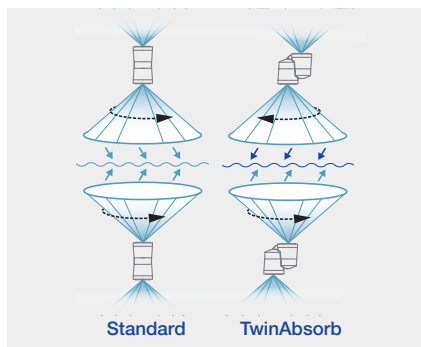

### Swirl effects

In improvement to standard tangential nozzles the TwinAbsorb series creates counter-rotating swirls whose droplets collide with higher energy and thus atomize much finer. At the same time studies show that the counter-rotating swirls support a most uniform gas distribution.

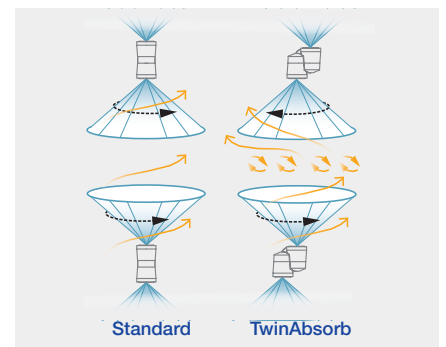

### Jet pump effects

Nozzles work like jet pumps and influence the spray turbulence. This increases the relative velocity of the droplets, which leads to finer atomization. The jet pump effect along with counter-rotating swirls significantly improves the separation of harmful gas components and particulates.



# TwinAbsorb

## The perfect counterpart to the TwinAbsorbPRO for the remaining scrubber sections

### Properties:

- Supports uniform gas distribution
- Improved mass transfer
- Optimized atomization
- Clogging insensitive

### Applications:

- Flue gas cleaning



Equilateral



Bi-directional

TwinAbsorb is the proven solution for scrubbers where no attention to header, piping or wall coverage is necessary. Four versions are available: Equilateral and bi-directional, each as double hollow cone or double full cone nozzle.

The equilateral nozzles TwinAbsorb-EH/TwinAbsorb-EV spray with two spray cones in one direction. TwinAbsorb-H/TwinAbsorb-V spray up and down, all providing additional droplet atomization while keeping the proven advantages of tangential nozzle types.

All models generate a counter-rotating swirl and an increased relative velocity of the droplets. This results in an intense secondary atomization and an extremely fine spray. Higher velocity difference between gas and injected liquid as well as a higher turbulence within the droplets lead to a considerably improved gas-to-liquid exchange while maintaining the largest possible total surface area for absorption.

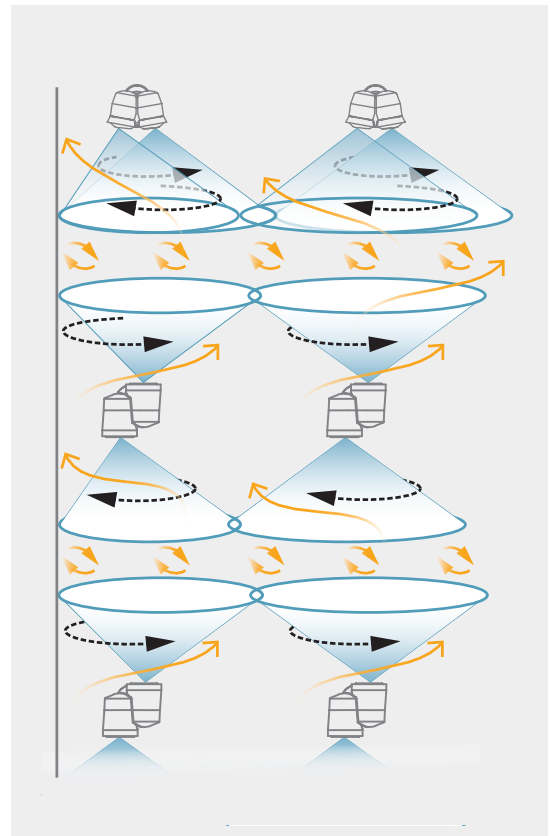

### Your benefits with TwinAbsorb

- Finer droplets (SMD d32) due to doubling of the spray cones.
- Improved mass transfer due to higher relative velocities to the gas stream.
- Better coverage of the scrubber edge zone.
- Reduced torque on the piping.
- Low maintenance thanks to the self-cleaning, clogging-resistant design and large free cross sections.

### Spray pattern

The spray angle of the TwinAbsorb can be adjusted between 70° and 120°. Standard operating pressure is between 0.5 and 2 bar. Other design data are available upon request. The flow rate depends on the application. The connection to the piping is available as thread, flange, clamp or glue/laminate connection.



TwinAbsorb Equilateral hollow cone



TwinAbsorb Bi-directional hollow cone



TwinAbsorb Equilateral full cone



TwinAbsorb Bi-directional full cone

## ➤➤ Additional services and products Maximum support for minimum emissions

In addition to the TwinAbsorb series, Lechler offers you an extensive range of nozzles for flue gas desulfurization, in various designs and materials, precisely tailored to your application.



Tangential nozzles made of SIC/NBSC



Axial nozzles made of SIC/NBSC/SISIC



Helix nozzles made of SISIC/Stainless steel/ alloys



### Twin4Absorb

Twin4Absorb nozzles are a further development of the TwinAbsorb nozzle series. Four overlapping spray cones generate additional jet collisions and create a more active reaction surface.

Thanks to the enhanced spatial distribution, the Twin4Absorb nozzles are ideal for optimizing existing scrubbers. TwinAbsorbPRO features are also available for this nozzle type.

### Talk to us

We are happy to support you at any time in making your processes lower in emissions and more efficient. Our CFD experts can simulate gas flows and thus optimize nozzle and lance arrangements. In the Lechler Technical Center, high-performance test facilities are available to test nozzles, connections and piping under practical conditions. Do not hesitate to contact us. We look forward to assisting you.

# ➤ DROPLET SEPARATOR SYSTEMS – WHEN PERFORMANCE COUNTS

Droplet separators have long played a vital role in many operating processes and gas cleaning plants as functional elements that protect downstream installation parts, increase product yield or reduce energy consumption. They are now becoming even more important due to increasingly stringent environmental protection regulations that require a drastic reduction in the residual pollutant content.

This makes it necessary to use high-performance droplet separators which are capable of separating even the finest droplets with a size of less than 10 micrometers, while at the same time

minimizing pressure losses. This task requires effective separation systems with compact dimensions that can deal with high flow rates. When designing and planning droplet separators, it is necessary to have exact knowledge of the functional and performance data of the separation system as well as an in-depth process understanding of the respective application. Extensive knowledge about droplet formation and droplet movement in a gas flow is essential to ensure fault-free operation of the droplet separator. For more than 100 years now, we have worked on detection, measurement and definition of droplets. Lechler nozzles and Lechler droplet separators are now considered integral elements in process engineering.

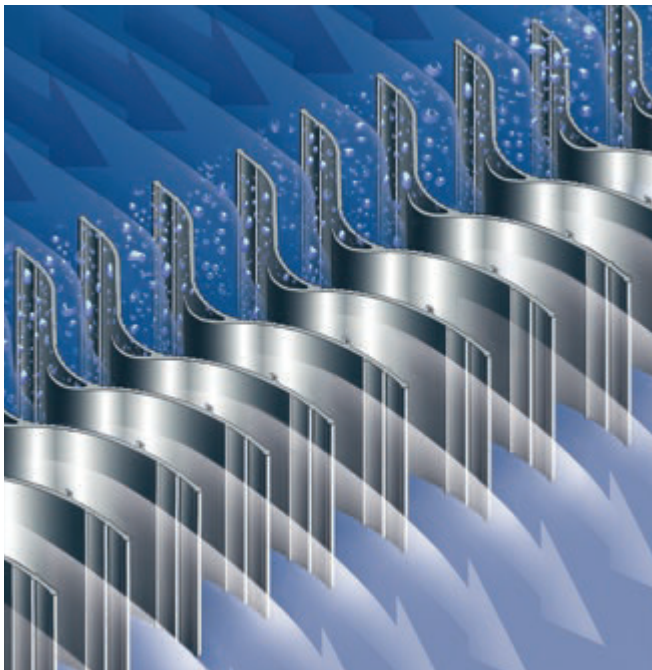

Each installation requires a specific droplet separator design and construction. Design, construction and selection of the optimum Lechler droplet separators are based fully on your requirements, specifications and drawings. That is why we do not offer standard solutions, but customize systems individually for your specific needs.

In order to guarantee fault-free operation, materials must be used that are matched to the relevant variables of the installation in question. For this reason, Lechler offers a wide range of different materials – also from stock.

## The available materials include

- Stainless steels in a lot of steel grades like 304, 316L, 316Ti, 318LN, 904L as well as special alloys such as Hastelloy
- Plastics such as PP, PPTV, PE, PVDF

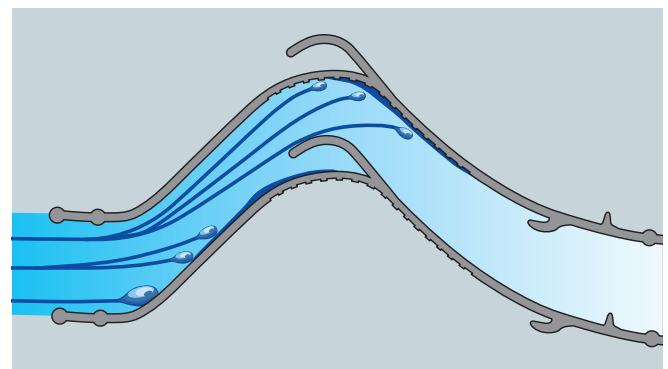
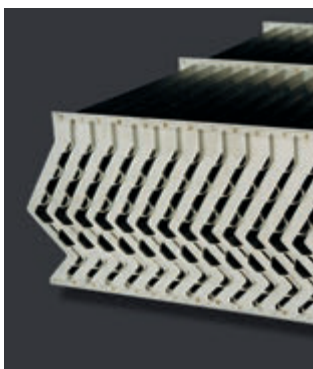

## Talk to us

Do you know your process but are not sure which droplet separator is best suited for your purposes? No problem. Based on your individual requirements, we will choose from a finely graded range of vane profiles with single or multiple deflection.

# ➤ Droplet separators for vertical gas flow

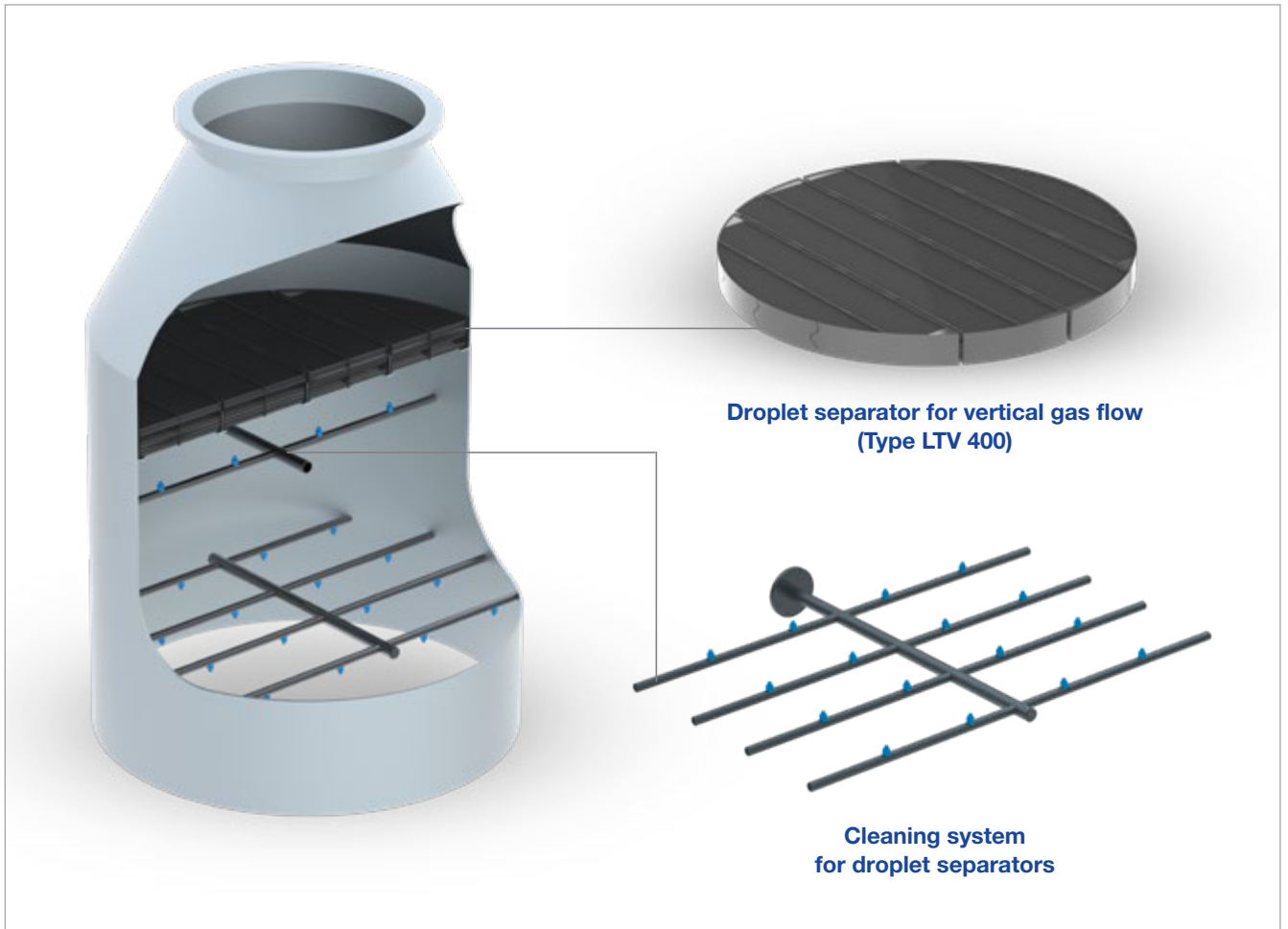

In **vane-type separators with vertical gas flow**, the baffle vanes are arranged horizontally or at a slight angle to the horizontal. The liquid that is separated at the profile forms a film which drains downwards in the opposite direction to the gas flow. This liquid film interacts with the opposing gas flow. At the bottom end, larger droplets are formed from the liquid film which then fall down.

## Reliable operation – even under tough conditions

Lechler droplet separators are characterized by their flow-optimized design. However, if the gas flows are heavily laden with dust, deposits can occur under unfavorable conditions which impair the efficiency of the droplet separators. In this case, an additional cleaning system helps guarantee continuous operation.

An arrangement that performs cyclical washing of the droplet separators with full-cone nozzles has proven particularly suitable for this. This allows you to increase functional reliability, avoid encrustations and also ensure that your plant operates with optimum efficiency over long periods.

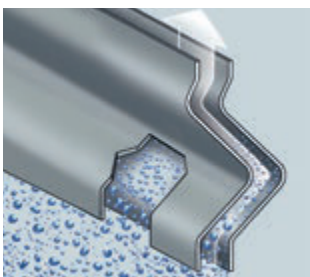

LTV 271 profile geometry

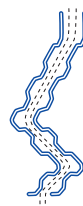

LTV 300 profile geometry



LTV 400 profile geometry

## ➤ Droplet separators for horizontal gas flow

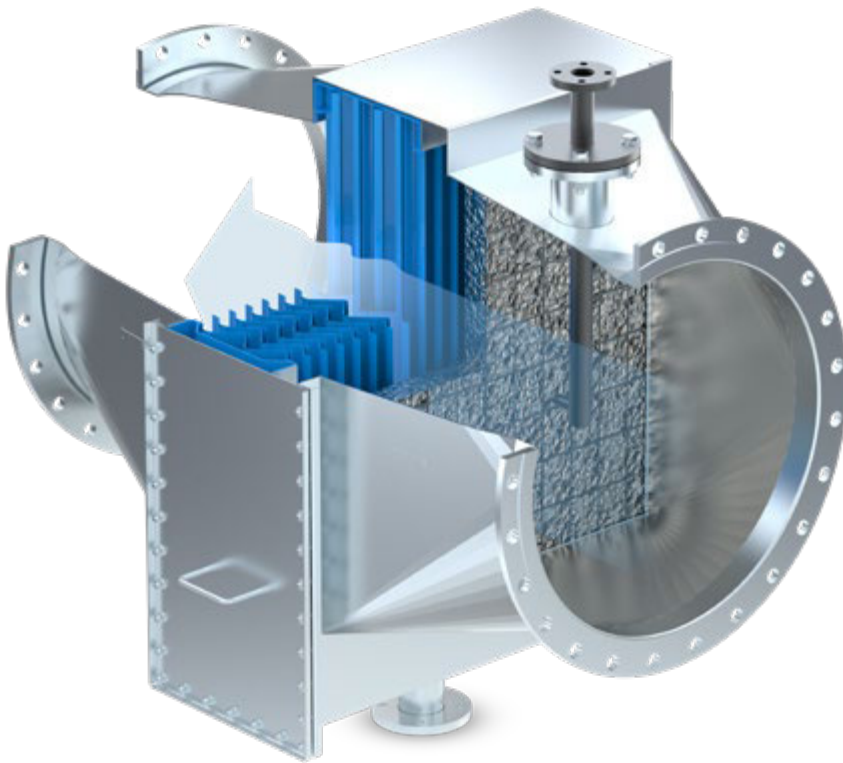

**Housing with droplet separator for horizontal gas flow (Type LTH 600) and agglomerator**



**Droplet separator for horizontal gas flow (Type LTH 600)**

**Vane-type separators for horizontal gas flow** use different design features for secondary separation than vertical systems. In vane-type separators for horizontal gas flow, the separation vanes are arranged vertically to the gas flow so that the liquid runs down the baffles due to gravity. The creation of flow-calmed zones allows the liquid film to specifically drain in these areas without renewed contact with the gas flow. The liquid run-off is assisted by the forces of gravity resulting in

high-performance separation systems. Depending on the separator design, particularly high flow rates are possible. The flow-optimized shape of the baffle vanes minimizes pressure losses.

Based on your individual requirements, you can choose from a finely-graded range of vane profiles with single or multiple deflection.

## Extreme droplet separation

### Ultra-fine droplets

In some applications, it is necessary to separate droplets that are significantly smaller than the limit droplet diameter of a vane-type droplet separator.

In these cases, we use fiber packs as agglomerators in combination with vane-type separators.

### Large liquid volumes

Optimum pre-separation is necessary if there are liquid surges in the inlet. The Lechler Inlet Device (LID) separates large liquid quantities with maximum efficiency and optimizes the flow of the rising gas.

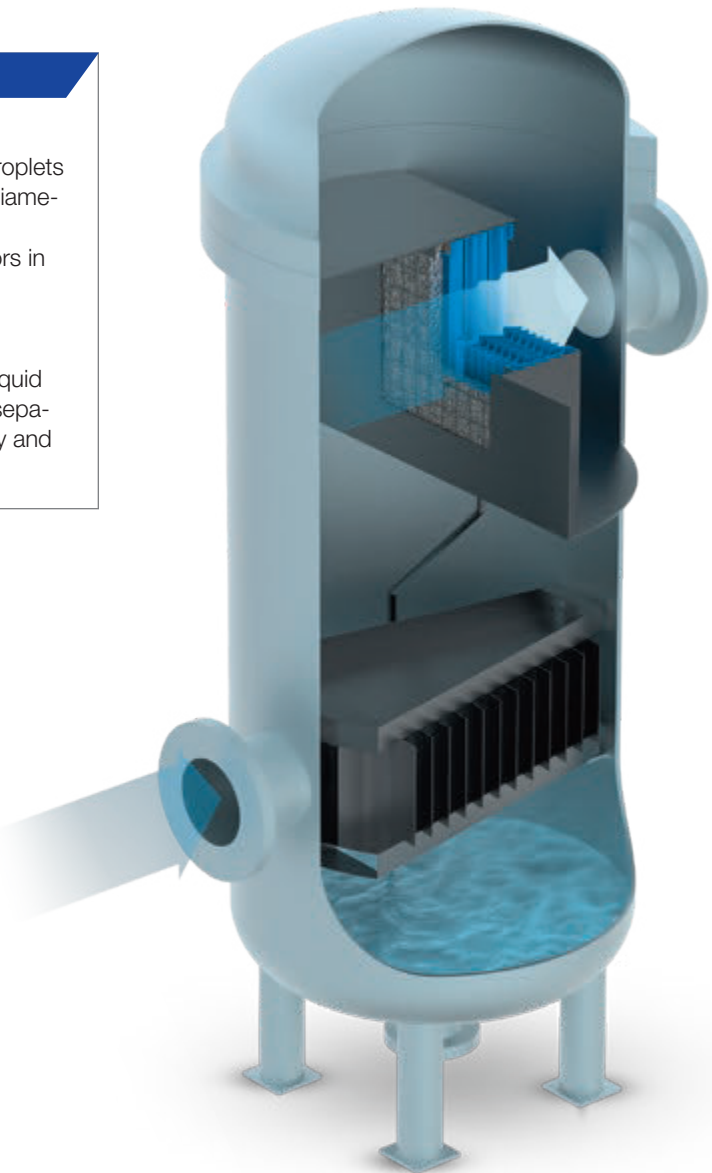
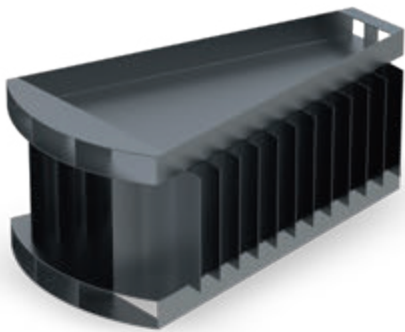

Pressure tank with an inlet device for separation of surge liquids



LTH 100 profile geometry

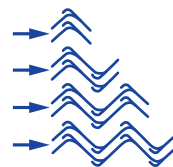

LTH 500 profile geometry

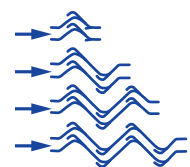

LTH 600 profile geometry



# CFD ANALYSIS FLOW OPTIMIZATION WITH COMPUTATIONAL FLUID DYNAMICS

No matter which kind of spray application we are facing, the goal is always to achieve the maximum effect with the minimum possible use of material, spray media and energy. It is therefore essential to have a detailed understanding of how spray mist is formed and propagated. This is made possible by computer-aided simulation of the flow processes (CFD – computational fluid dynamics) of one or more substances in static or dynamic environments taking into account heat and mass transfer.

These simulations incorporate our many decades of experience from the field of nozzle development. Initially, CFD was an internal tool which helped us to develop a desired nozzle more quickly and precisely. Our latest high-performance cluster enables us to offer our experience as a service. We simulate nozzle applications and processes individually for your environment and your requirements. So that your processes also run perfectly in real life.

## Our services

- Calculation of the flow field including pressure losses with one or more flowing media in pipes and fittings
- Spray propagation including heat and mass transfer with the surrounding gases under practically all conceivable ambient conditions
- Calculation of internal nozzle flows and prediction of the spray pattern, water distribution and spray characteristics down to droplet sizes in the near-nozzle range

## Your advantages

- Maximum efficiency in regards to:
  - the use of expensive consumable media
  - geometric dimensions of the overall spray process
- Maximum efficiency through targeted optimization of:
  - nozzle selection
  - nozzle operating point (taking into account your pumps, compressors and blowers)
  - liquid distribution
  - droplet sizes
  - inflow and outflow of your process gases in relation to the spray process (with the aim of achieving uniformity and reducing pressure losses)





## Construction

The flow behavior of gases is significantly determined by the shape of the environment. By applying computer simulation using computational fluid dynamics (CFD), our specialists can detect unequal gas distributions as well as turbulence. Depending on the specific conditions, these issues can be resolved in different ways. Installing baffles, perforated plates or even repositioning nozzles can be simulated to achieve the desired flow characteristics. The result of optimized gas flow via CFD can significantly reduce energy and/or material requirements.

### Optimization of the gas flow in the gas cooling tower

#### Benefits:

- Efficient cooler operation thanks to lower atomizing air consumption and/or lower connection pressures at the nozzle lances
- Wet ground avoided as well as possible caking on the inner wall of the cooler
- Stable process in various load cases

#### Before

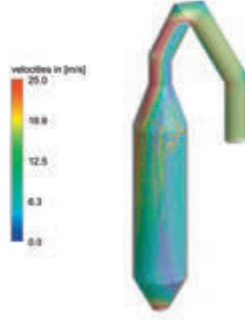

#### After

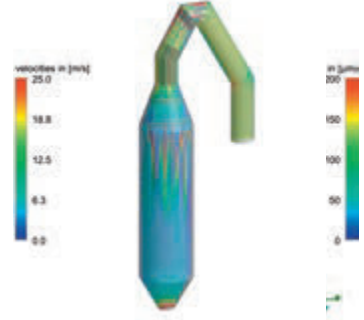

### Optimization of SNCR process – best possible selection and placement of nozzles

#### Benefits:

- Reactive ammonia vapor is present where the gas containing nitrogen (NO<sub>x</sub>) flows
- Avoidance of unnecessary NH<sub>3</sub> slip, meaning efficient use of the ammonia solution
- Best possible reduction rates of nitrogen oxides

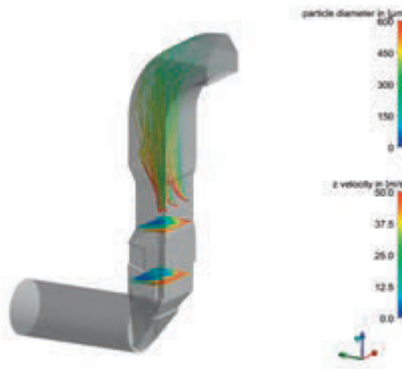

### Design and continuous optimization of our products

#### Benefits

- Optimal atomization effect
- Efficient use of the connected atomization media
- Reduction of the required nozzle connection pressures
- Individual nozzle development in the shortest time

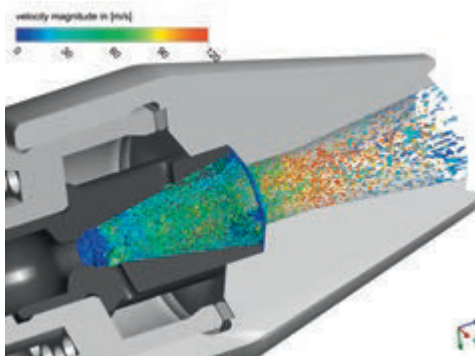



# MEASURING TECHNOLOGY

## HOW OUR RESOURCES HELP US ACHIEVE PRECISION



### **The basis for precision nozzle development**

At Lechler, exact measurements have long been the basis for clearly defined spray characteristics. The data obtained in our laboratories forms the foundation for development and makes it easier for our customers to choose nozzles for specific applications. This saves time, lowers costs and provides planning security.

### **Advanced technology**

We have further expanded our research capacities by opening our own Development and Technology Center.

On an area of 600 m<sup>2</sup>, we can measure the velocity and size of individual droplets in sprays, determine distribution gradients and also analyze large-volume structures. In addition, different injection processes can be reproduced and compared in a test gas cooler.

### **International cooperation**

We at Lechler value the importance of international cooperation. This is often what opens up new perspectives on a problem. Cooperation offers us the possibility of testing nozzles in very special test environments and of discovering new use scenarios in this way.



## Our experience for your success

With our experienced engineering team, you have a reliable partner for your project at all times – from technical design and detail engineering to commissioning and replacement of spare and wearing parts. You will benefit from direct contact and fewer communication channels to enable smooth completion of your project.

## Exclusive solutions

Lechler offers a system solution tailored to your application and plant-specific conditions. We use only high-quality components from renowned manufacturers for our valve skid units. If you choose a system with a control, you will get a complete solution for your gas cooling and conditioning requirement from a single source.

## Reliable service is part of our agreement

Even after your system has been delivered, you are in good hands with Lechler. We offer a worldwide commissioning service provided by employees with many years of experience. A signal and performance test ensures optimal system operation taking all operating and safety aspects into consideration. An important point of commissioning is also the detailed briefing of operating and maintenance personnel in the operation and maintenance of the plant.

We are your competent partner who will provide you with assistance to solve your problems. Our on-site service for preventive maintenance ensures continuous operation. We will be more than happy to draw up a maintenance contract tailored to your needs.

## From digital to real

Each individual design of gas cooling and conditioning systems is based on innovative software. CFD calculations are used for flow optimization. Using a 3D tool, we identify the optimum liquid distribution in the duct together with the necessary lance arrangement. Our drawings are created using state-of-the-art design engineering software.

## Extensive documentation

Our nozzle lances and systems are designed and manufactured in line with the current standards and regulations. New plants are always delivered with project-related documentation containing all relevant information for commissioning, operation and maintenance. Lechler will also provide a verbal description of the function and control concept where desired.

## Future-proof

Lechler systems are built to withstand harsh conditions and enable reliable and long-term operation. We understand the extreme process conditions within the waste-to-energy plants industry. Which is why it is all the more important to us to have a guaranteed long-term supply of spare parts for wearing parts – worldwide. With our global network of representatives, we offer a worldwide platform for contact and advice. You will find your competent contacts on the Lechler website.

**ENGINEERING  
YOUR SPRAY SOLUTION**



**Lechler GmbH · Precision Nozzles · Nozzle Systems**

**Ulmer Strasse 128 · 72555 Metzingen, Germany · Phone +49 7123 962-0 · [aqcs@lechler.de](mailto:aqcs@lechler.de) · [www.lechler.com](http://www.lechler.com)**

**ASEAN:** Lechler Spray Technology Sdn. Bhd. · No. 23 Jalan, Teknologi 3/3A · Kota Damansara · 47810 PJ, Malaysia · Phone +603 6142 1288 · [info@lechler.com.my](mailto:info@lechler.com.my)

**Belgium:** Lechler S.A./N.V. · Avenue Newton 4 · 1300 Wavre · Phone +32 10 225022 · [info@lechler.be](mailto:info@lechler.be)

**China:** Lechler Nozzle Systems (Changzhou) Co., Ltd. · No.99 Decheng Rd, Jintan, Changzhou, JS 213200, P.R.C · Phone +86 519-6822 8088 · [info@lechler.com.cn](mailto:info@lechler.com.cn)

**Finland:** Lechler Oy · Ansatie 6 a C 3 krs · 01740 Vantaa · Phone +358 207 856880 · [info@lechler.fi](mailto:info@lechler.fi)

**France:** Lechler France SAS · Bât. CAP2 · 66-72 Rue Marceau · 93100 Montreuil · Phone +33 1 49882600 · [info@lechler.fr](mailto:info@lechler.fr)

**Great Britain:** Lechler Ltd. · 1 Fell Street, Newhall · Sheffield, S9 2TP · Phone +44 114 2492020 · [info@lechler.com](mailto:info@lechler.com)

**India:** Lechler (India) Pvt. Ltd. · Plot B-2 · Main Road · Wagle Industrial Estate Thane · 400604 Maharashtra · Phone +91 22 40634444 · [lechler@lechlerindia.com](mailto:lechler@lechlerindia.com)

**Italy:** Lechler Spray Technology S.r.l. · Via Don Dossetti, 2 · 20080 Carpiano (Mi) · Phone +39 2 98859027 · [info@lechleritalia.com](mailto:info@lechleritalia.com)

**Russia:** Lechler Rus · OOO, 108811, Moscow, Settlement Moskovskiy, Kiewskoe Chaussee km 22 · Object 4, Bld. 2, Block G, Floor 6, Office 601/G · [info@lechler-rus.ru](mailto:info@lechler-rus.ru)

**Spain:** Lechler, S.A. · C / Isla de Hierro, 7 – Oficina 1.3 · 28703 San Sebastián de los Reyes (Madrid) · Phone +34 91 6586346 · [info@lechler.es](mailto:info@lechler.es)

**Sweden:** Lechler AB · Kungsängsvägen 31B · 753 23 Uppsala · Phone +46 18 167030 · [info@lechler.se](mailto:info@lechler.se)

**USA:** Lechler Inc. · 445 Kautz Road · St. Charles, IL 60174 · Phone +1 630 3776611 · [info@lechlerusa.com](mailto:info@lechlerusa.com)