

ENGINEERING  
YOUR SPRAY SOLUTION

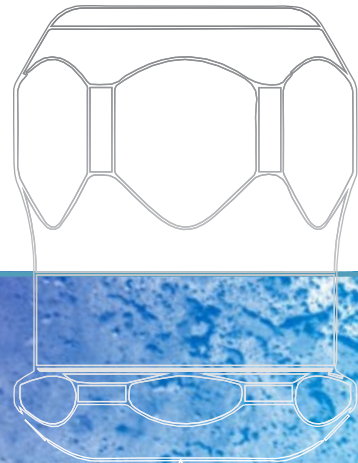

➤➤ DryMASTER  
Nozzle mastery for the  
spray drying industry

GENERAL INDUSTRY



**DryMASTER**



# 140 YEARS OF MASTERING DROPS AND PARTICLES

From the beginning, more than 140 years ago, we have had a soft spot for fine details.

How are desired properties for droplets created? How are they distributed correctly? How can the different processes be optimized? Today, more than 700 employees all over the world seek and find answers to these questions. In our own Development and Technology Center in Metzingen, Germany, we simulate complex spray characteristics, develop state of the art nozzles and test them thoroughly under realistic conditions.

Over all these years, we have acquired a deep understanding of processes in a wide range of industries. Beyond high-performance precision nozzles, we also support our customers in optimizing their processes.

For detailed information about our range of services, please visit:  
[www.lechler.com](http://www.lechler.com)





## CONTENTS

---

140 years of mastering  
drops and particles 2–3

Powder to the people  
How we help you  
help your customers 4–5

The art of designing  
a million droplets at once 6

Isn't this a step back? 7

Matter matters  
Why we have a soft spot  
for hard carbides 8–9

**DryMASTER**  
One unique concept,  
hundreds of applications 10–11

**DryMASTER**  
The new standard for  
most applications 12–13

**DryMASTER CheckValve**  
Keeps unwanted dripping  
under control 14–15

**Special products**  
Expand your options 16–17

Let's get technical  
Planning aids to  
support you 18–19

"Want it all? At once?"  
Welcome to your  
one stop shop 20–21

Assembly at a glance 22

A unique range of air  
atomizing nozzles 23

At your service 23

140  
1879 - 2019

2010

Expansion of production  
with a new 13,000 m<sup>2</sup>  
manufacturing plant

2016

New Development and  
Technology Center is  
opened in Metzingen

2019

Celebrating 140 years

2021

State of the art factories  
are built in India and China

2022

New logistics center  
in Metzingen



# POWDER TO THE PEOPLE HOW WE HELP YOU HELP YOUR CUSTOMERS

For optimum results in spray drying, an understanding of substances and nozzle design must go hand in hand. We know your products and understand their behavior. And if it is something new to us, our state of the art CFD analysis and high-precision size and velocity measuring apparatus, help us learn how they interact with our spray nozzles. This way, we can advise you comprehensively on the right nozzle, assembly choice and operating parameters to suit your process.

With 6 production sites and 14 subsidiaries worldwide, we have a presence near you and are always happy to provide you with the best possible support.

## WHY CHOOSE LECHLER?

WORLDWIDE SALES NETWORK PROVIDING LOCAL SUPPORT

YOUR ONE STOP SHOP FOR SPRAY TECHNOLOGY

THE ONLY FDA-COMPLIANT FULL NOZZLE ASSEMBLY

UNIQUE MATERIAL – FOOD-SAFE AND HARDER WEARING

RAPID DELIVERY

FASTER RETURN ON INVESTMENT

DESIGN BACKED BY MULTI MILLION EURO R & D FACILITY





**Food safety**

Lechler's DryMASTER series has achieved EU1935/2004 and is both FDA and GB4806 compliant. Choosing Lechler means choosing a safe, hygienic product.



# THE ART OF DESIGNING A MILLION DROPLETS AT ONCE

Before we build the nozzle, we design the spray. It always starts with the requirements of the respective application along with the upstream and downstream processes. This applies to spray drying as well. Methods such as CFD make it possible for us to perfectly match the individual components to each other, and achieve an optimum spray pattern with minimal nozzle wear.

## The centrifugal atomizing nozzle

Centrifugal atomizing nozzles atomize the droplets by pressure alone. This allows for greater throughput and tighter control of the droplets minimizing fines. It also reduces the risk of contamination as well as the operating costs.

The medium fed into the nozzle is set in rotation in the swirl chamber and forms a very rapidly rotating liquid column. Making its way through the orifice disc component, the centrifugal energy of the feed material makes the high velocity column follow the outer wall of the bore. A cross section through the orifice disc shows a hollow cone spray pattern forming a void co-linear with the central axis.

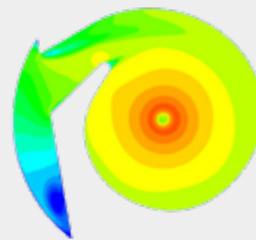

Swirl profile

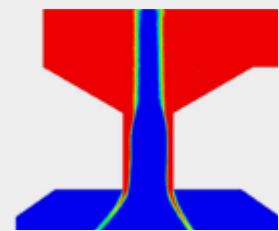

Cross section through the orifice disc

The centrifugal force breaks the liquid into droplets as it leaves the orifice disc. The higher the energy, the finer the droplets. The swirl chamber, orifice disc and operating pressure determine the spray angle, the flow rate and the droplet size.

## Effects on spray parameters

Example	Pressure at nozzle [bar]	Swirl chamber	Orifice disc [mm/°]	Flow rate [l/h]	Spray angle [°]	Droplet size [µm]
<b>Example A</b> (based on water)	250	SD	1.85/0.073	<b>522</b>	77	47
<b>Example B</b> (based on water)	250	SF	1.85/0.073	<b>792</b>	63	41
<b>Example C</b> (based on water)	250	SD	2.30/0.091	<b>660</b>	78	52

As you can see in Example B, increasing the swirl chamber volume, dramatically increases the flow rate whilst reducing the spray angle by 14° and decreasing the droplet size by 6 µm.

On the other hand, example C shows how increasing the orifice disc size only, increases the flow rate whilst maintaining the spray angle and increasing the droplet size by 4 µm.



Orifice disc



Swirl chamber

# » ISN'T THIS A STEP BACK?

## One step ahead

In the late 1970s, the first spray drying nozzles with separate orifice discs appeared. Subsequently, various suppliers introduced orifice discs with additional geometric features. Recent CFD investigations by Lechler have shown that these do not bring any functional advantages, and in some cases can impact the homogeneousness of the spray distribution. Our measurements showed that flat orifice discs tend to provide a better spray pattern, which is why we at Lechler rely on short bores for optimal performance.



### The standard so far: Long bore orifice disc

The longer bore causes variable flow velocities, which ultimately create a non-uniform, asymmetrical spray cone.

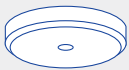
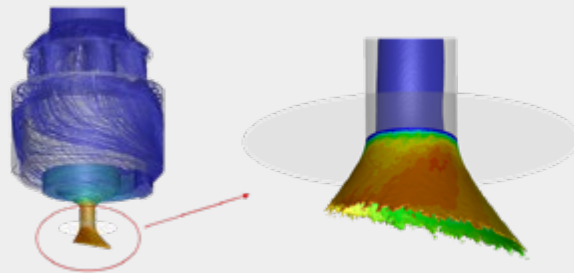

### The new benchmark: DryMASTER orifice disc

In comparison, the orifice disc of a DryMASTER nozzle shows a considerably more uniform spray density and speed.

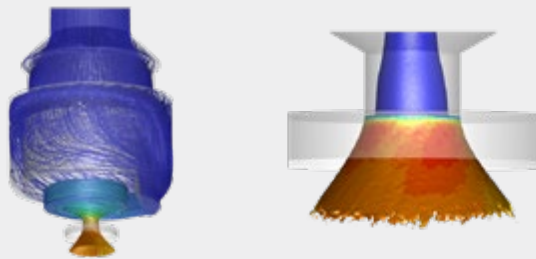

# »» MATTER MATTERS

## WHY WE HAVE A SOFT SPOT FOR HARD CARBIDES

An efficient spray drying process depends on spray nozzles with long service life. This means making some of the harder working components from materials that are, well, hard.

At the same time, these components must be hygienic and easy to clean. Tungsten carbide is the common material of choice for this application. However due to its molecular structure, some mediums and even CIP processes can break down the tungsten carbide binder. We therefore need to consider not only abrasion and erosion but also chemical reactions for wear.

Lechler's DryMASTER series not only provides a unique tungsten carbide grade which boasts a superior wear rate compared to other nozzle manufacturers, and better withstands chemical attack due to its unique binder technology, but it does this while being certified in accordance with FDA, EU1935/2004 and GB4806.

### LECHLER CARBIDE RECYCLING (CARE)



When the tungsten wear parts are finally spent, what happens to them? To date, these parts have simply been discarded. But what if there was a sustainable alternative that reversed the manufacturing process back to the raw material ready for reuse?

The Lechler Carbide Recycling program offers just that – the ability to return your spent tungsten carbide nozzle spares for recycling. This way, you not only reduce your carbon footprint, but also benefit financially. For the quantity returned, you will receive a credit to your account.

Lechler's CaRe program aims to conserve limited primary resources, while reducing the consequences of intensive mining such as the pollution of air, water and soil.

### Potential energy savings and reduction of the total CO<sub>2</sub> balance

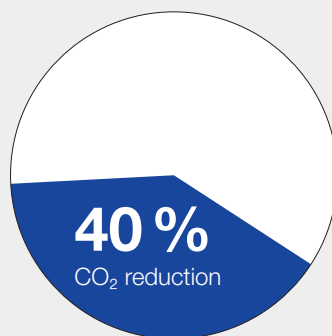
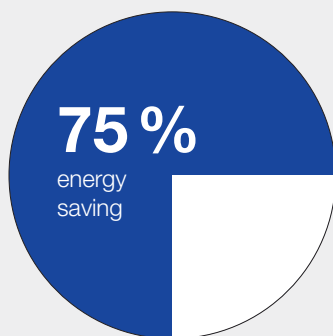

When tungsten is recovered by recycling from secondary raw materials, significant energy and CO<sub>2</sub> savings are possible.

### Contact your local office

Should you wish to learn more of Lechler's CaRe program, or are interested in adopting the scheme, please don't hesitate to contact your local Lechler representative. Carbide recycling program not available in all regions.



# The carbide powder circle

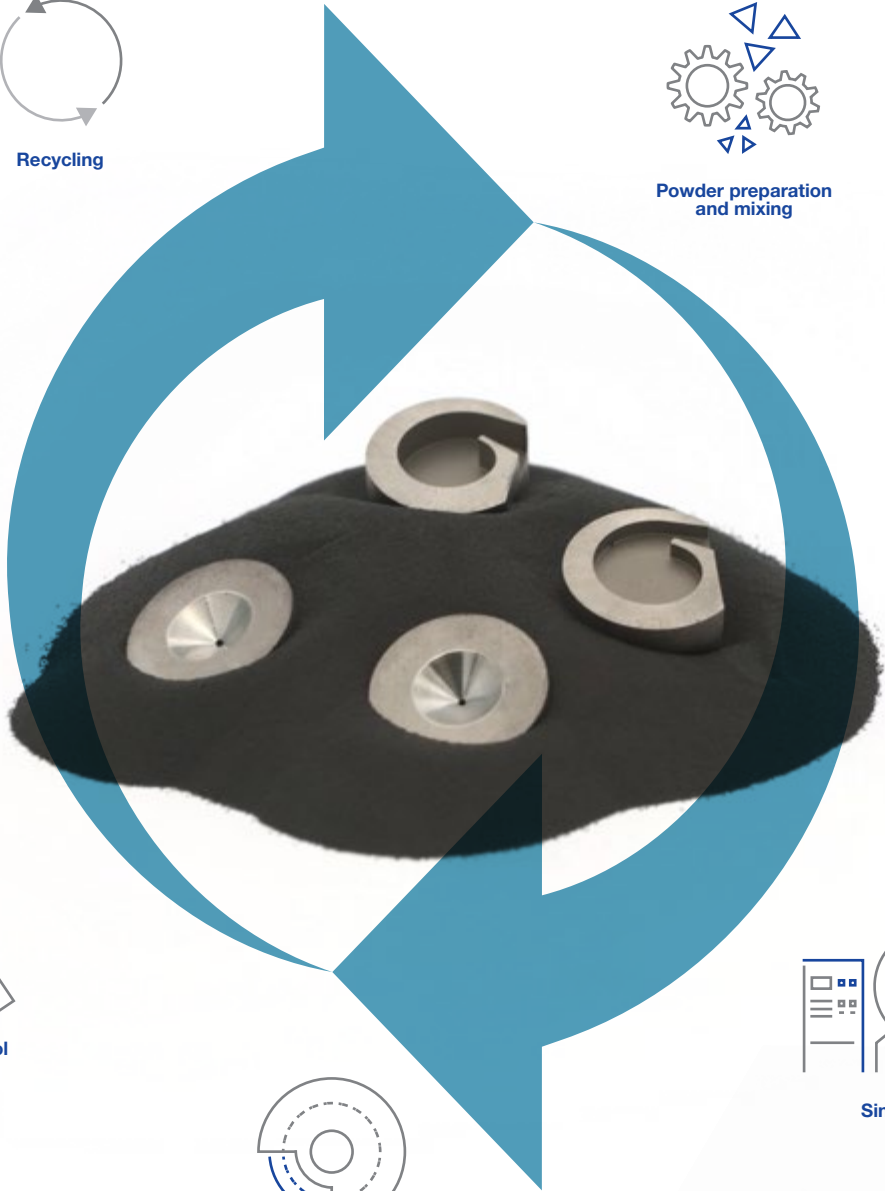
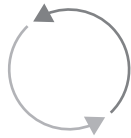
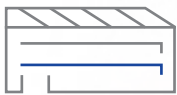
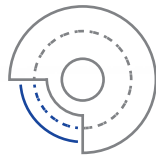
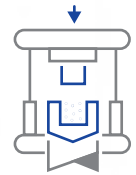
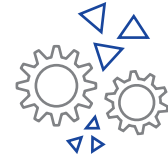



# DryMASTER

## ONE UNIQUE CONCEPT, HUNDREDS OF APPLICATIONS

The Lechler DryMASTER was specifically designed as a modular series in order to cover different applications with as much interchangeability as possible, guarantee easy maintainability and yet achieve the best atomization results.

The focus is on the swirl chambers and orifice discs. Over 900 combinations are available, among them the one that suits your process perfectly.

Using the very latest technological advances and manufacturing techniques in tungsten carbide production, our DryMASTER series not only leads the market in precision engineering, but also in wear life – maintaining critical performance dimensions for longer. Designed with the food and drug industries in mind, Lechler’s DryMASTER series meets EU1935/2004, FDA and GB4806 requirements.

And no matter which version you choose, you can always rely on the following advantages.

### Your benefits

#### Superior wear life

Process-specific materials providing greater resistance to abrasion and chemical attack.

#### Rapid maintenance

Hand tight design with engineered geometry making it easier to clean and service without any tooling.

#### Versatility

Many build options and accessories to support a wide range of processes.

#### High pressure integrity

Tested up to 690 bar (10,000 psi).

#### Compatibility

Hassle-free swap out with other nozzle brands.

#### Value for money

Competitive pricing for a longer lasting improved product.

#### High availability

Most sizes ex stock or from blank, meaning delivery within days.

### For a safe and healthy production

The Lechler DryMASTER series is EU1935/2004, FDA and GB4806 compliant and has proven its value in co-current, counter current and mixed flow dryers to produce powders such as:

- Whey
- Whole milk
- Skim milk
- Protein concentrate
- Infant formula
- Chemicals
- Ceramics
- Pharmaceuticals
- Cosmetics

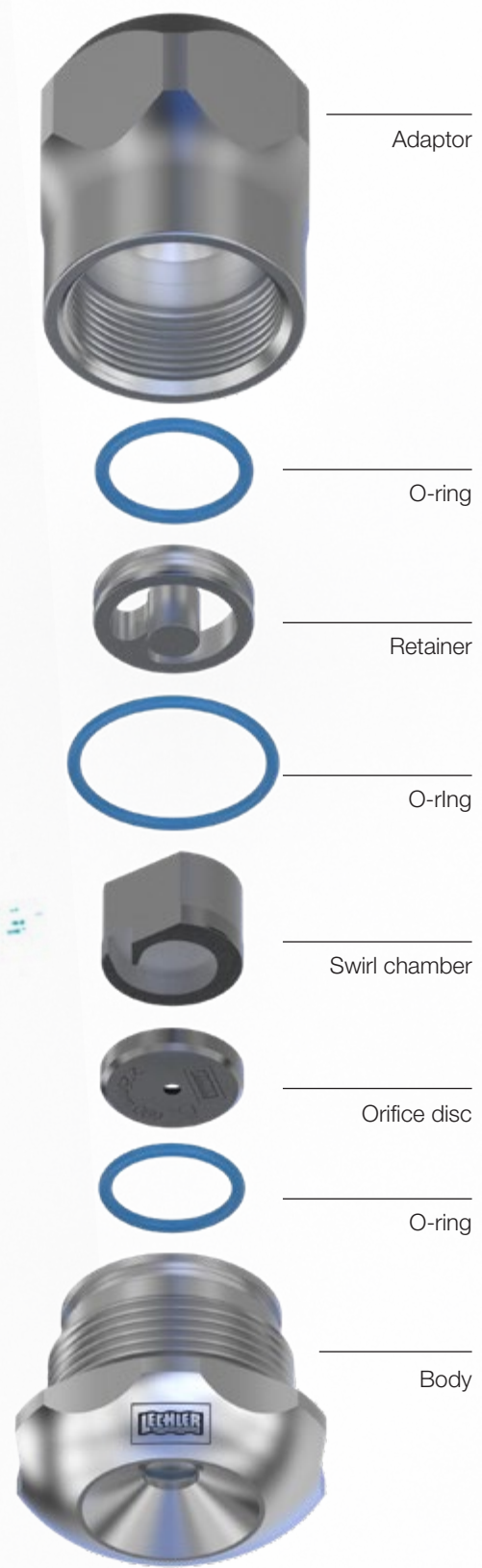

# ➤ DryMASTER

## The new standard for most applications

Thanks to the modular design of Lechler's DryMASTER series, a suitable assembly can be found for almost any application. Every component has been specifically designed for its intended use. Supporting a wide operating range, the DryMASTER series offers end users a higher yield with superior quality longer lasting technology.

### Technical data

- Over 900 orifice disc and swirl chamber combinations
- Flow range: 10–12,000 l/h
- Operating pressure: max. 465 bar at 20 °C (BP 1,000 bar, calculated)
- Operating temperature: max. 250 °C
- Spray angles: 50°–110°
- Droplet size: 30 µm to 220 µm

Additional configurations are available. Please contact the office for operating parameters outside of our published figures. Pressure and temperature charts available to download on our website.

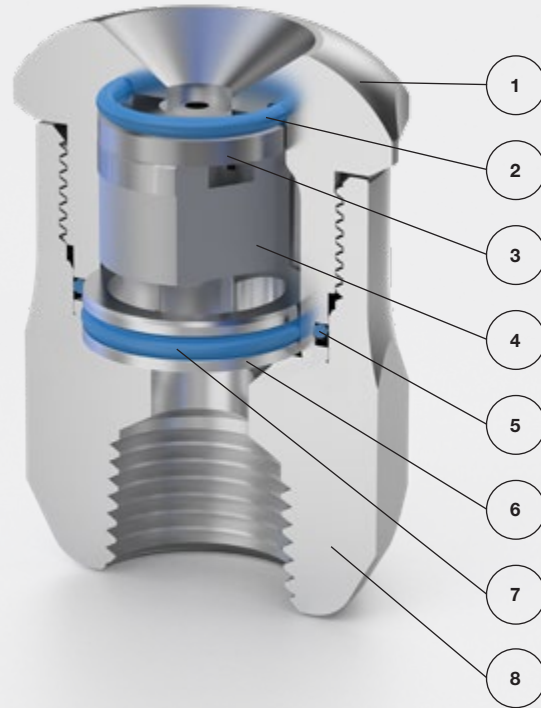

### Options



9



10



11

### Accessories



12



13

No.	Component	Material All materials approved by FDA	Order No.	Variable	Description			
1	DryMASTER standard body	SS 316L	<a href="#">2DM.B00.1Y.00.00.0</a>		The standard body for most applications			
2	O-ring for orifice disc	FDA FKM	<a href="#">095.015.79.12.22.0</a>		Included in seal kit (item 12)			
3	DryMASTER orifice disc Ø 0.40–5.60 mm	WNC carbide	<a href="#">2DM.xxx.27.00.00.0</a>	xxx	In the order number xxx marks the diameter. It ranges from 0.40 to 5.60 mm in 0.05 mm increments.  Example: an orifice disc with a diameter of 4.55 mm would be <a href="#">2DM.455.27.00.00.0</a> Other sizes available on request			
4	DryMASTER swirl chamber	WNC carbide	<a href="#">2DM.SCx.27.00.00.0</a>	x	Swirl chamber size A to J for example, SCD			
5	O-ring for DryMASTER body	FDA FKM	<a href="#">095.015.79.12.23.0</a>		Included in seal kit (item 12)			
6	DryMASTER retainer	SS 316L	<a href="#">2DM.R00.1Y.00.00.0</a>		Retainer to keep orifice disc and swirl chamber in position			
7	O-ring for DryMASTER retainer	FDA FKM	<a href="#">095.015.79.10.12.0</a>		Included in seal kit (item 12)			
8	DryMASTER threaded adaptor	1/4" BSPT	SS 318LN	<a href="#">2DM.A00.B2.CD</a>	For spray drying lances with threaded connection			
		3/8" BSPT	SS 318LN	<a href="#">2DM.A00.B2.CF</a>				
		1/2" BSPT	SS 318LN	<a href="#">2DM.A00.B2.CH</a>				
		3/4" BSPT	SS 318LN	<a href="#">2DM.A00.B2.CL</a>				
		1/4" NPT	SS 318LN	<a href="#">2DM.A00.B2.BD</a>				
		3/8" NPT	SS 318LN	<a href="#">2DM.A00.B2.BF</a>				
		1/2" NPT	SS 318LN	<a href="#">2DM.A00.B2.BH</a>				
9	DryMASTER cone face body	SS 316L	<a href="#">2DM.B00.1Y.xx.x0.0</a>	xx.x	Cone angle from 60° to 110° in 5° steps. E.g. 06.0 for 60°, 07.5 for 75° and 11.0 for 110°.  Examples: 60°: <a href="#">2DM.B00.1Y.06.00.0</a> 105°: <a href="#">2DM.B00.1Y.10.50.0</a>			
						1/4" SCH.40	SS 318LN	<a href="#">2DM.A45.B2.W1.44.0</a>
						3/8" SCH.40	SS 318LN	<a href="#">2DM.A45.B2.W3.84.0</a>
						1/2" SCH.40	SS 318LN	<a href="#">2DM.A45.B2.W1.24.0</a>
						3/4" SCH.40	SS 318LN	<a href="#">2DM.A45.B2.W3.44.0</a>
						1/4" SCH.80	SS 318LN	<a href="#">2DM.A45.B2.W1.48.0</a>
						3/8" SCH.80	SS 318LN	<a href="#">2DM.A45.B2.W3.88.0</a>
10	DryMASTER 45° butt weld adaptor	SS 318LN	<a href="#">2DM.A45.B2.W1.48.0</a>		Adapter with 45°-angled welding inlet connection			
						1/4" SCH.40	<a href="#">2DM.A45.B2.W1.44.0</a>	
						3/8" SCH.40	<a href="#">2DM.A45.B2.W3.84.0</a>	
						1/2" SCH.40	<a href="#">2DM.A45.B2.W1.24.0</a>	
						3/4" SCH.40	<a href="#">2DM.A45.B2.W3.44.0</a>	
						1/4" SCH.80	<a href="#">2DM.A45.B2.W1.48.0</a>	
						3/8" SCH.80	<a href="#">2DM.A45.B2.W3.88.0</a>	
11	DryMASTER butt weld adaptor	SS 318LN	<a href="#">2DM.A00.B2.W1.48.0</a>		Adapter with butt weld inlet connection			
						1/4" SCH.40	<a href="#">2DM.A00.B2.W1.44.0</a>	
						3/8" SCH.40	<a href="#">2DM.A00.B2.W3.84.0</a>	
						1/2" SCH.40	<a href="#">2DM.A00.B2.W1.24.0</a>	
						3/4" SCH.40	<a href="#">2DM.A00.B2.W3.44.0</a>	
						1/4" SCH.80	<a href="#">2DM.A00.B2.W1.48.0</a>	
						3/8" SCH.80	<a href="#">2DM.A00.B2.W3.88.0</a>	
12	DryMASTER seal kit	FDA FKM and lubricant	<a href="#">02D.MSP.79.00.00.0</a>		Seal kit, including 100 O-rings of each size (see 2, 5 and 7) and food grade grease			
						1/2" SCH.80	<a href="#">2DM.A00.B2.W1.28.0</a>	
13	Disassembly tool	Aluminum	<a href="#">02D.M90.40.00.00.0</a>		For easy removal of the orifice disc, the swirl chamber as well as the retainer out of the nozzle body			

You can order online at [www.lechler.com](http://www.lechler.com) or through your Lechler sales partner.

# ➤ DryMASTER CheckValve

## Keeps unwanted dripping under control

Dripping nozzles can hinder both process reliability and product quality. The DryMASTER CheckValve ensures that „off“ is really „off“. Lechler's DryMASTER CheckValve is designed to open at atomizing pressure, and shut off before the loss of atomization. It reliably prevents dripping due to latent line pressures and the resulting clumping in the end product. Furthermore, the check valve ensures that no flushing medium enters the cooling chamber or the fluid bed.

The compact and reliable DryMASTER CheckValve nozzles can be easily screwed into existing spray lances. Thanks to their sophisticated, hygienic design, they require very little maintenance and are very easy to clean.

### Technical data

- Over 900 orifice disc and swirl chamber combinations
- Flow range: 10–12,000 l/h
- Operating pressure: max. 465 bar at 20 °C (BP 1,000 bar, calculated)
- Operating temperature: max. 250 °C
- Spray angles: 50°–110°
- Droplet size: 30 µm to 220 µm

Additional configurations are available. Please contact the office for operating parameters outside of our published figures. Pressure and temperature charts available to download on our website.

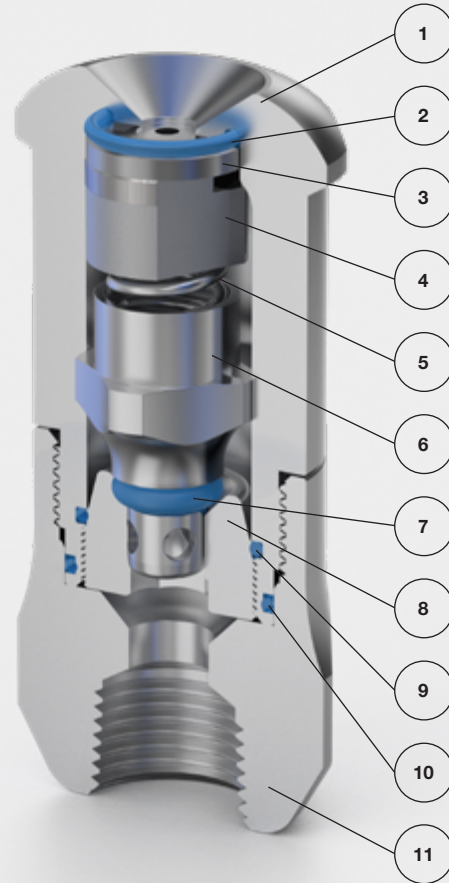

### Options



12



13

### Accessories



14

No.	Component	Material All materials approved by FDA	Order No.	Variable	Description
1	DryMASTER CheckValve body	SS 316L	<b>2DM.CV0.1Y.00.01.0</b>		
2	O-ring for orifice disc	FDA FKM	<b>095.015.79.12.22.0</b>		Included in seal kit (item 14)
3	DryMASTER orifice disc Ø 0.40–5.60 mm	WNC carbide	<b>2DM.xxx.27.00.00.0</b>	xxx	In the order number xxx marks the diameter. It ranges from 0.40 to 5.60 mm in 0.05 mm increments. Example: an orifice disc with a diameter of 4.55 mm would be <b>2DM.455.27.00.00.0</b> Other sizes available on request
4	DryMASTER swirl chamber	WNC carbide	<b>2DM.SCx.27.00.00.0</b>	x	Swirl chamber size A to J for example, SCD
5	CheckValve spring	SS 302	<b>095.013.15.06.90.0</b>		
6	CheckValve seat body	SS 316L	<b>2DM.CV0.1Y.00.03.0</b>		
7	O-ring for CheckValve seat	FDA FKM	<b>095.015.79.12.51.0</b>		Included in seal kit (item 14)
8	DryMASTER CheckValve retainer	SS 316L	<b>2DM.CV0.9E.00.02.0</b>		Threaded retainer to keep internal components positively retained
9	O-ring for CheckValve retainer	FDA FKM	<b>095.015.79.12.57.0</b>		Included in seal kit (item 14)
10	O-ring for CheckValve body	FDA FKM	<b>095.015.79.12.23.0</b>		Included in seal kit (item 14)
11	DryMASTER threaded adaptor	1/4" BSPT	SS 318LN	<b>2DM.A00.B2.CD</b>	For spray drying lances with threaded connection
		3/8" BSPT	SS 318LN	<b>2DM.A00.B2.CF</b>	
		1/2" BSPT	SS 318LN	<b>2DM.A00.B2.CH</b>	
		3/4" BSPT	SS 318LN	<b>2DM.A00.B2.CL</b>	
		1/4" NPT	SS 318LN	<b>2DM.A00.B2.BD</b>	
		3/8" NPT	SS 318LN	<b>2DM.A00.B2.BF</b>	
		1/2" NPT	SS 318LN	<b>2DM.A00.B2.BH</b>	
12	DryMASTER 45° butt weld adaptor	1/4" SCH.40	SS 318LN	<b>2DM.A45.B2.W1.44.0</b>	Adapter with 45°-angled welding inlet connection
		3/8" SCH.40	SS 318LN	<b>2DM.A45.B2.W3.84.0</b>	
		1/2" SCH.40	SS 318LN	<b>2DM.A45.B2.W1.24.0</b>	
		3/4" SCH.40	SS 318LN	<b>2DM.A45.B2.W3.44.0</b>	
		1/4" SCH.80	SS 318LN	<b>2DM.A45.B2.W1.48.0</b>	
		3/8" SCH.80	SS 318LN	<b>2DM.A45.B2.W3.88.0</b>	
		1/2" SCH.80	SS 318LN	<b>2DM.A45.B2.W1.28.0</b>	
13	DryMASTER butt weld adaptor	1/4" SCH.40	SS 318LN	<b>2DM.A00.B2.W1.44.0</b>	Adapter with butt weld inlet connection
		3/8" SCH.40	SS 318LN	<b>2DM.A00.B2.W3.84.0</b>	
		1/2" SCH.40	SS 318LN	<b>2DM.A00.B2.W1.24.0</b>	
		3/4" SCH.40	SS 318LN	<b>2DM.A00.B2.W3.44.0</b>	
		1/4" SCH.80	SS 318LN	<b>2DM.A00.B2.W1.48.0</b>	
		3/8" SCH.80	SS 318LN	<b>2DM.A00.B2.W3.88.0</b>	
		1/2" SCH.80	SS 318LN	<b>2DM.A00.B2.W1.28.0</b>	
14	DryMASTER CheckValve seal kit	FDA FKM	<b>02D.MSP.79.00.01.0</b>		Seal kit, including 100 O-rings for orifice disc and body (see 2 and 10), 20 pieces CheckValve seat O-ring (see 7), 20 pieces CheckValve retainer O-ring (see 8), food grade grease and disassembly tool

You can order online at [www.lechler.com](http://www.lechler.com) or through your Lechler sales partner.

# Special products

## Expand your options

Lechler don't just do spray nozzles. For 100 years we have been supporting our customers with spray headers, spray lances, manifolds, valves and much more. Get in touch with your local office to find out how we can support you with lance repairs, modifications and replacements.

### DryMASTER Low Flow

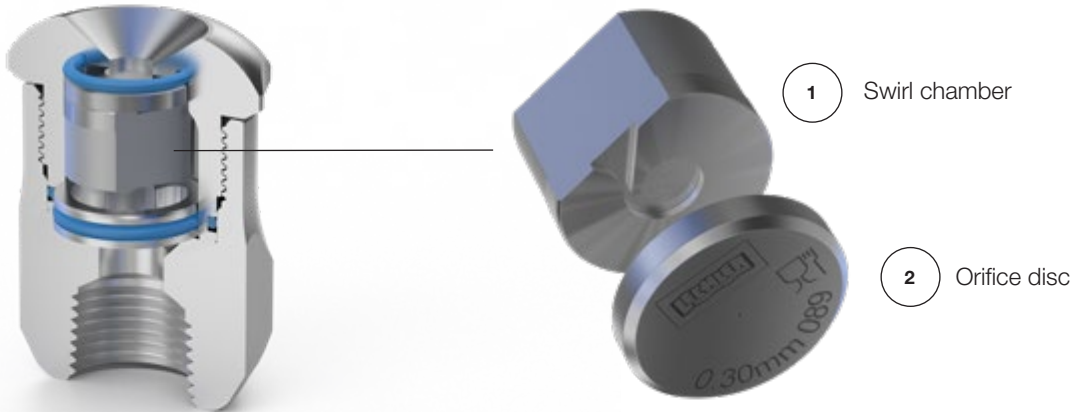

With the DryMASTER Low Flow, much smaller production volumes can be achieved with comparable back pressures and spray profiles to larger systems. The Low Flow assembly achieves this by simply swapping out the orifice disc and swirl chamber, giving the end user complete flexibility with existing plant and equipment.

#### Technical data

- An additional 60 orifice disc and swirl chamber combinations
- Flow range: 0.27 l/min–4.20 l/min
- Operating pressure: max. 465 bar at 20 °C (BP 1,000 bar, calculated)
- Spray angles: 30°–90°

No.	Component	Order No.
1	Low Flow swirl chamber size 1	<a href="#">2DM.SC1.27.LF.00.0</a>
	Low Flow swirl chamber size 2	<a href="#">2DM.SC2.27.LF.00.0</a>
	Low Flow swirl chamber size 3	<a href="#">2DM.SC3.27.LF.00.0</a>
	Low Flow swirl chamber size 4	<a href="#">2DM.SC4.27.LF.00.0</a>
2	Low Flow orifice disc size 0.30 mm	<a href="#">2DM.030.27.LF.00.0</a>
	Low Flow orifice disc size 0.35 mm	<a href="#">2DM.035.27.LF.00.0</a>
	Low Flow orifice disc size 0.40 mm	<a href="#">2DM.040.27.LF.00.0</a>
	Low Flow orifice disc size 0.45 mm	<a href="#">2DM.045.27.LF.00.0</a>
	Low Flow orifice disc size 0.50 mm	<a href="#">2DM.050.27.LF.00.0</a>
	Low Flow orifice disc size 0.55 mm	<a href="#">2DM.055.27.LF.00.0</a>
	Low Flow orifice disc size 0.60 mm	<a href="#">2DM.060.27.LF.00.0</a>
	Low Flow orifice disc size 0.65 mm	<a href="#">2DM.065.27.LF.00.0</a>
	Low Flow orifice disc size 0.70 mm	<a href="#">2DM.070.27.LF.00.0</a>
	Low Flow orifice disc size 0.75 mm	<a href="#">2DM.075.27.LF.00.0</a>
	Low Flow orifice disc size 0.80 mm	<a href="#">2DM.080.27.LF.00.0</a>
	Low Flow orifice disc size 0.85 mm	<a href="#">2DM.085.27.LF.00.0</a>
	Low Flow orifice disc size 0.90 mm	<a href="#">2DM.090.27.LF.00.0</a>
	Low Flow orifice disc size 0.95 mm	<a href="#">2DM.095.27.LF.00.0</a>
	Low Flow orifice disc size 1.00 mm	<a href="#">2DM.100.27.LF.00.0</a>



## DryMASTER Multi Head Adaptor

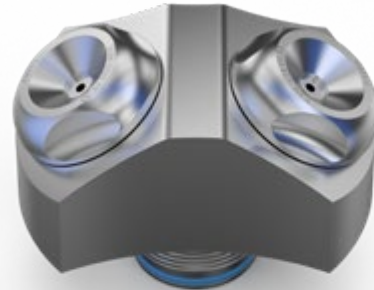

The DryMASTER Multi Head Adaptor enables the user to triple throughput while maintaining back pressure and spray profiles. Designed to fit into an 80 mm duct and attach to your standard nozzle fitting on the end of your spray lance, allowing the end user to increase capacity with minimal change to equipment.

- Fits into existing nozzle adaptor
- Designed for 80 mm penetration duct
- Easy to assemble and maintain
- No modification required to existing spray lance

Component	Order No.
DryMASTER Multi Head Adaptor 3 Ports	<a href="#">2DM.AS0.1Y.03.00.0</a>
DryMASTER Multi Head Adaptor 2 Ports	<a href="#">2DM.AS0.1Y.02.00.0</a>
DryMASTER body for Multi Head Adaptor	<a href="#">2DM.BS0.1Y.00.00.0</a>

## Spray lances

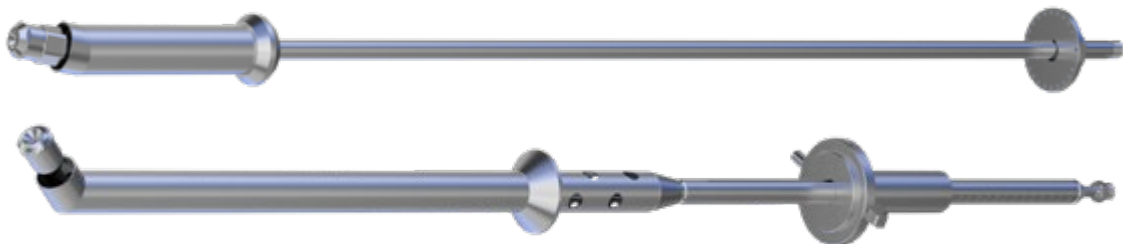

Manufactured with care and produced from Stainless Steel Duplex/316L, we provide only the highest quality equipment to work in harmony with the spray nozzle. Lechler can offer any design modifications to the spray lance design to work better with your production processes.



# LET'S GET TECHNICAL PLANNING AIDS TO SUPPORT YOU

The characteristics of a spray jet depend on various parameters. In the following, we have compiled a brief overview of the most important ones. If you need support in planning or adapting spray processes, please do not hesitate to contact us. We are always at your side.

## Flow rate and liquid pressure

$$\frac{GPH_1}{GPH_2} = \frac{\sqrt{PSI_1}}{\sqrt{PSI_2}}$$

$$\frac{LPH_1}{LPH_2} = \frac{\sqrt{BAR_1}}{\sqrt{BAR_2}}$$

The operating pressure of a nozzle determines the flow rate. The formulas show the dependencies of the two variables.

## Specific gravity

$$GPH_{(WATER)} = GPH_{(LIQUID)} \cdot \sqrt{SG_{(LIQUID)}}$$

$$LPH_{(WATER)} = LPH_{(LIQUID)} \cdot \sqrt{SG_{(LIQUID)}}$$

The flow rate is directly related to the specific gravity of a liquid. The equivalent flow rate for water relative to a given specific gravity is calculated as shown in the formulas on the left.

## Spray angle

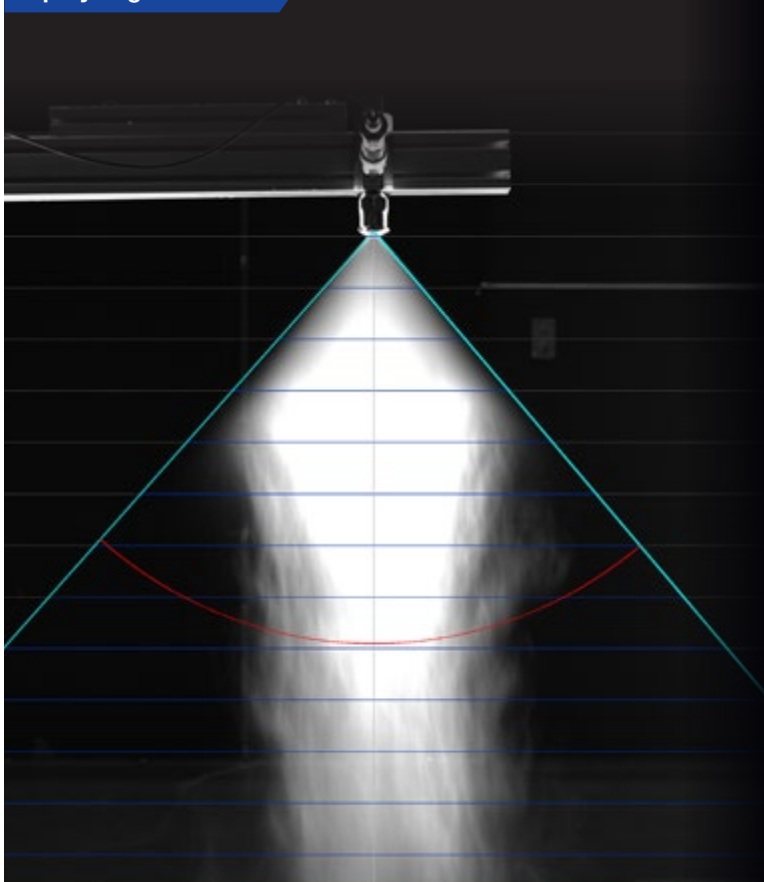

In practice, the effective spray angle deviates from the nominal spray angle of a nozzle. Gravity causes it to become smaller with increasing distance from the nozzle opening. In addition, the medium's viscosity also affects the spray angle. Highly viscous substances form smaller angles, whereas thinner substances form larger angles.

Depending on the operating pressure, air and friction losses, as well as ballistic influences, the affect on the jet pattern and the size of the impinged area will vary. If atomization is performed under counterpressure, the volume flow depends on the differential pressure. Maximum and minimum pressures depend on the required jet quality.

## Droplet size

One of the controlling specifications of a nozzle operating within a spray dryer is the droplet size. While the wet droplet size being projected from the nozzle doesn't directly correlate to the dried particle size being produced by the dryer, it is used to suggest a nozzle build in accordance with the powder specification.

The droplet size that a spray nozzle produces is often quoted as "Sauter Mean Diameter" (SMD,  $d_{32}$ ). Simplified this expresses an average droplet size from the spray sample. SMD,  $d_{32}$  gives the diameter of a droplet whose ratio of volume to surface area is equal to that of the complete sample and can be expressed as:

$$\text{SMD, } d_{32} = (\sum n_i d_i^3) / (\sum n_i d_i^2) = (D_{30})^3 / (D_{20})^2$$

## Yield

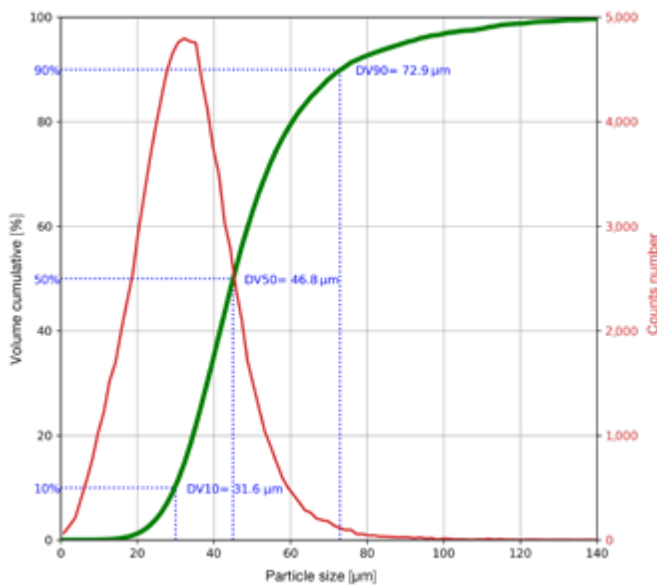

Understanding the droplets from a spray drying nozzle can help unlock the key to understanding how to maximize the production yield. Although the Sauter Mean Diameter can explain the average droplet size within a spray sample, it does not explain the size of the very smallest and very largest droplets. It is these droplets that produce unwanted "fines" and hinder dryer efficiencies. While  $D_{\min}$  and  $D_{\max}$  values explain the minimum and maximum drop size by volume (or mass) present in the spray sample, the Relative Span Factor (RSF) can indicate the uniformity (width) of the droplet size distribution. This can be defined as;

$$\text{RSF} = \frac{D_{V0.9} - D_{V0.1}}{D_{V0.5}}$$

## Contact your local office

All droplet size values are derived from the properties of water and are used in order to suggest a nozzle build. To enquire further, please contact your local Lechler sales representative.



# WANT IT ALL? AT ONCE? WELCOME TO YOUR ONE STOP SHOP

At Lechler, we do not consider ourselves just a nozzle manufacturer, but rather a solution provider for all atomization tasks. We provide you with comprehensive support, from the planning of new processes and the improvement of spray technology used in existing spray drying systems, to maintenance issues and training.

## Flow simulation as a service

In spray drying, everything depends on having the right droplet size in the right place at the right time. But how can this be achieved? We have been continuously optimizing this for over 140 years. In the beginning, we relied on trial and error. Today we use state of the art simulation methods such as CFD.

Our high-performance clusters with a computing power of around 8,500 GFlops not only enable the development of customized nozzles, but also the optimization of existing spray drying processes. We simulate nozzle applications and processes individually for your environment and your requirements.



## Contact your local office

For detailed information about our range of services, please contact your local Lechler sales representative.

### Everything for spray drying plants

With Lechler as your partner, you are best prepared for all eventualities. We support you from the planning of new plants and the operation of existing spray drying systems to all modernization issues. In short: Lechler is your one stop shop for everything related to spray drying. Can't quite find what you need? Contact your local representative about a customized solution!

Bagfilter house



### RinseClean 5B2/5B3

- Powder ducts
- Fluidbed



### MicroSpinner 2 5M2

- Powder ducts



### 490/491 (fire suppression)

- SprayDrying tower



### PopUp Whirly

- Fluid bed
- Bagfilter house
- Powder ducts



### XactClean HP/HP+

- Air ducts
- Fluid bed
- Powder ducts

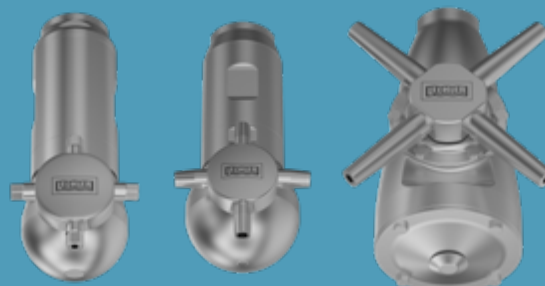

### IntenseClean Hygienic 5TA/5TB/5TM

- SprayDrying tower

# ASSEMBLY AT A GLANCE

## Assembly procedure in ten steps

The assembly of a spray drying nozzle is done in a few simple steps. All parts can be easily placed together without the need for special tools.



Gather all components to make the assembly. Note there are three different sizes of O-ring.



Place the smallest O-ring inside the nozzle body at the very bottom.



Place the orifice disc, plain bore facing downwards, on top of the O-ring.



Place the swirl chamber, swirl profile facing downwards, on top of the orifice disc.



Assemble middle sized O-ring onto the retainer and apply a "dot" of grease to the circumference.



Insert the retainer disc into the body ensuring the raised profile sits on the back of the swirl chamber.



Now assemble the largest O-ring onto the nozzle body.



Apply a "dot" of grease to the circumference of the seal.



Insert (screw) the nozzle body into the nozzle adaptor – this can already be mounted on the spray lance.



Hand tight only, screw down the nozzle body until it bottoms in the adaptor. There should be a "paper" thin visible gap between the adaptor and underside of the body.

## Check out our YouTube channel



YouTube

### Want to see it in motion?

On our YouTube channel you will find illustrative videos on the assembly and maintenance of Lechler's DryMASTER nozzles plus much more!

## »» A UNIQUE RANGE OF AIR ATOMIZING NOZZLES



Lechler's uniquely broad portfolio of atomizing nozzles also includes extremely high-performance products for air atomization. Air atomizing nozzles are used across nearly all industries, spray drying being one of those. Offering a low pressure solution to atomization, air atomizing nozzles are commonly used in pilot dryers and small production dryers due to the small droplets produced.

## »» AT YOUR SERVICE

**In the end it's all about quality and availability. We help you to achieve continuous high yields.**

### **Training and service**

If requested, we will be happy to train your personnel in the use of Lechler nozzles and accessories, and provide tips on how to avoid unplanned downtime. We will show you what to look for in carbide components, what wear symptoms can occur, and when a replacement is recommended.

### **Modernization and revamping**

Quality assurance. Cost control. Energy efficiency. No industry can ignore these three keywords. By coordinating upstream and downstream processes in spray drying, there can be considerable potential for optimization. We would be pleased to advise you on the possibilities in your plant. Just get in touch with us.

### **CFD**

In order to achieve optimum particle sizes and powder qualities, droplet sizes and distributions must be precisely matched to the respective conditions. With our own test laboratory, we can ensure that everything fits perfectly – from spray characteristics and angle, droplet distribution and coverage, to impact and wear. Our validated computational fluid dynamics (CFD) models, allow the simulation of gas flows, droplet and particle trances, heat and mass transfer like evaporation, temperature profiles and a lot more!

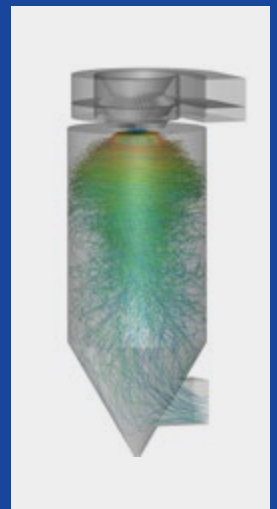

**ENGINEERING  
YOUR SPRAY SOLUTION**



**Lechler GmbH · Precision Nozzles · Nozzle Systems**

**Ulmer Strasse 128 · 72555 Metzingen, Germany · Phone +49 7123 962-0 · info@lechler.de · www.lechler.com**

**ASEAN:** Lechler Spray Technology Sdn. Bhd. · No. 23 Jalan, Teknologi 3/3A · Kota Damansara · 47810 PJ, Malaysia · Phone +603 6142 1288 · info@lechler.com.my

**Belgium:** Lechler S.A./N.V. · Avenue Newton 4 · 1300 Wavre · Phone +32 10 225022 · info@lechler.be

**China:** Lechler Nozzle Systems (Changzhou) Co., Ltd. · No.99 Decheng Rd, Jintan, Changzhou, JS 213200, P.R.C · Phone +86 519-6822 8088 · info@lechler.com.cn

**Finland:** Lechler Oy · Ansatie 6 a C 3 krs · 01740 Vantaa · Phone +358 207 856880 · info@lechler.fi

**France:** Lechler France SAS · Bât. CAP2 · 66-72 Rue Marceau · 93100 Montreuil · Phone +33 1 49882600 · info@lechler.fr

**Great Britain:** Lechler Ltd. · 1 Fell Street, Newhall · Sheffield, S9 2TP · Phone +44 114 2492020 · info@lechler.com

**India:** Lechler (India) Pvt. Ltd. · Plot B-2 · Main Road · Wagle Industrial Estate Thane · 400604 Maharashtra · Phone +91 22 40634444 · lechler@lechlerindia.com

**Italy:** Lechler Spray Technology S.r.l. · Via Don Dossetti, 2 · 20080 Carpiano (Mi) · Phone +39 2 98859027 · info@lechleritalia.com

**Russia:** Lechler Rus · OOO, 108811, Moscow, Settlement Moskovskiy, Kiewskoe Chaussee km 22 · Object 4, Bld. 2, Block G, Floor 6, Office 601/G · info@lechler-rus.ru

**Spain:** Lechler, S.A. · C / Isla de Hierro, 7 – Oficina 1.3 · 28703 San Sebastián de los Reyes (Madrid) · Phone +34 91 6586346 · info@lechler.es

**Sweden:** Lechler AB · Kungsängsvägen 31B · 753 23 Uppsala · Phone +46 18 167030 · info@lechler.se

**USA:** Lechler Inc. · 445 Kautz Road · St. Charles, IL 60174 · Phone +1 630 3776611 · info@lechlerusa.com