

**Technical data**

Temperature range -20 °C to +120 °C

**Electrical data**

Max. continuous nominal current 2.1 A (70 °C), power contacts

Mating cycles 1,000

Product range Yamaichi Y-CONKIT			
Product range	igus® Part No.	Number of poles	Protection class
<b>Housing PA66</b>			
Y-CONKIT 10	MAT01719769	4 (Ethernet)	IP20
Y-CONKIT 11	MAT0176641	4 (Ethernet) + 2 (Power)	IP20
<b>Housing Zinc die-casting</b>			
Y-CONKIT 17	MAT01719770	4 (Ethernet)	IP20
Y-CONKIT 15	MAT01719236	4 (Ethernet) + 2 (Power)	IP20
<b>Housing Plastic PBT, UL94V-0</b>			
Y-CONKIT 20	MAT01719771	4 (Ethernet)	IP67/68/69K
Y-CONKIT 21	MAT0176759	4 (Ethernet) + 2 (Power)	IP67/68/69K
<b>Housing Zinc die-casting</b>			
Y-CONKIT 40	MAT01719772	4 (Ethernet)	IP67/68/69K
Y-CONKIT 40-E	MAT01719773	4 (Ethernet)	IP67/68/69K
Y-CONKIT 41	MAT01717218	4 (Ethernet) + 2 (Power)	IP67/68/69K
Y-CONKIT 41-E	MAT01718801	4 (Ethernet) + 2 (Power)	IP67/68/69K

Product range Yamaichi Y-CONKIT accessoires	
Product range	igus® Part No.
<b>Crimping tool</b>	
Y-ConTool-11	MAT0176447
<b>Cable dismantle tool</b>	
	MAT01719767
<b>Assembly tool</b>	
Y-ConTool-30	MAT01717349



HARTING Connectors sets, pin				
Part No.	Cable entry	Insert	Pin insert HARTING Part No.	Housing HARTING Part No.
Han 6B connector housing, straight cable entry <b>MAT90489802.U</b>	M20	6+PE	09330062601	19300061440
Han 6B connector housing, angled cable entry <b>MAT90489804.U</b>	M20	6+PE	09330062601	19300061540
Han 10B connector housing, straight cable entry <b>MAT90489806.U</b>	M25	10+PE	09330102601	19300101441
Han 10B connector housing, angled cable entry <b>MAT90489808.U</b>	M25	10+PE	09330102601	19300101541
Han 16B connector housing, straight cable entry <b>MAT90489810.U</b>	M25	16+PE	09330162601	19300161441
Han 16B connector housing, angled cable entry <b>MAT90489812.U</b>	M25	16+PE	09330162601	19300161541
Han 24B connector housing, straight cable entry <b>MAT90489814.U</b>	M32	24+PE	09330242601	19300241442
Han 24B connector housing, angled cable entry <b>MAT90489816.U</b>	M32	24+PE	09330242601	19300241542

HARTING Connector sets, socket				
Part No.	Cable entry	Insert	Socket-inserts HARTING Part No.	Housing HARTING Part No.
Han 6B connector housing, straight cable entry <b>MAT90489803.U</b>	M20	6+PE	09330062701	19300061440
Han 6B connector housing, angled cable entry <b>MAT90489805.U</b>	M20	6+PE	09330062701	19300061540
Han 10B connector housing, straight cable entry <b>MAT90489807.U</b>	M25	10+PE	09330102701	19300101441
Han 10B connector housing, angled cable entry <b>MAT90489809.U</b>	M25	10+PE	09330102701	19300101541
Han 16B connector housing, straight cable entry <b>MAT90489811.U</b>	M25	16+PE	09330162701	19300161441
Han 16B connector housing, angled cable entry <b>MAT90489813.U</b>	M25	16+PE	09330162701	19300161541
Han 24B connector housing, straight cable entry <b>MAT90489815.U</b>	M32	24+PE	09330242701	19300241442
Han 24B connector housing, angled cable entry <b>MAT90489817.U</b>	M32	24+PE	09330242701	19300241542

# HARTING | Connector sets Premium (pin + socket)

HARTING Connector sets Premium, pin + socket						
Part No.	Cable entry	Insert	Pin-insert HARTING Part No.	Socket-insert HARTING Part No.	Connector housing HARTING Part No.	Connector base HARTING Part No.
Han 6B connector housing and base, straight cable entry						
<b>MAT90489818.U</b>	M20	6+PE	09330062601	09330062701	19300061440	19300061250
Han 6B connector housing and base, angled cable entry						
<b>MAT90489819.U</b>	M20	6+PE	09330062601	09330062701	19300061540	19300061250
Han 10B connector housing and base, straight cable entry						
<b>MAT90489820.U</b>	M25	10+PE	09330102601	09330102701	19300101441	19300101250
Han 10B connector housing and base, angled cable entry						
<b>MAT90489821.U</b>	M25	10+PE	09330102601	09330102701	19300101541	19300101250
Han 16B connector housing and base, straight cable entry						
<b>MAT90489822.U</b>	M25	16+PE	09330162601	09330162701	19300161441	19300161251
Han 16B connector housing and base, angled cable entry						
<b>MAT90489823.U</b>	M25	16+PE	09330162601	09330162701	19300161541	19300161251
Han 24B connector housing and base, straight cable entry						
<b>MAT90489824.U</b>	M32	24+PE	09330242601	09330242701	19300241442	19300241251
Han 24B connector housing and base, angled cable entry						
<b>MAT90489825.U</b>	M32	24+PE	09330242601	09330242701	19300241542	19300241251

# HUMMEL | Cable glands HSK-K

**Material** PA V0 according to UL 94  
**Moulded seal** NBR  
**Protection class** IP 68 – 10 bar / IP 69K  
 within the specified clamping range only with optional O-Ring  
**Continuous operating temperature** -40 °C to +100 °C  
**Colour** grey (RAL 7035)



AG	mm	GL	H	mm	mm	Pack size	Part No. grey	igus® Part No.
M 12 x 1.5	3 - 6.5	8	21	15	5	1.209.1200.50	MAT0179492	
M 12 x 1.5	2 - 5	8	21	15	5	1.209.1200.51	MAT01712319	
M 16 x 1.5	4 - 8	8	22	19	5	1.209.1600.50	MAT0179493	
M 16 x 1.5	2 - 6	8	22	19	5	1.209.1600.51	MAT01712320	
M 16 x 1.5	5 - 10	8	25	22	5	1.219.1600.50	MAT01712321	
M 20 x 1.5	6 - 12	9	27	24	5	1.209.2000.50	MAT0179494	
M 20 x 1.5	5 - 9	9	27	24	5	1.209.2000.51	MAT01712322	
M 20 x 1.5	10 - 14	9	28	27	5	1.219.2000.50	MAT0179563	
M 25 x 1.5	13 - 18	11	31	33	5	1.209.2500.50	MAT0179495	
M 25 x 1.5	9 - 16	11	31	33	5	1.209.2500.51	MAT01712323	
M 32 x 1.5	18 - 25	11	39	42	5	1.209.3200.50	MAT0179496	
M 32 x 1.5	13 - 20	11	39	42	5	1.209.3200.51	MAT01712324	
M 40 x 1.5	22 - 32	13	48	53	5	1.209.4000.50	MAT0179497	
M 40 x 1.5	20 - 26	13	48	53	5	1.209.4000.51	MAT01712325	
M 50 x 1.5	32 - 38	13	49	60	5	1.209.5000.50	MAT0179498	
M 50 x 1.5	25 - 31	13	49	60	5	1.209.5000.51	MAT01712326	
M 63 x 1.5	37 - 44	14	49	65 / 68	5	1.209.6300.50	MAT0179499	
M 63 x 1.5	29 - 35	14	49	65 / 68	5	1.209.6300.51	MAT01712327	

Cable diameter in mm

1 2 3 4 5 6 7 8 9 10 11 12 13 14 15 16 17 18 19 20 21 22 23 24 25 26 27 28 29 30 31 32 33 34 35 36 37 38 39 40 41 42 43 44 45

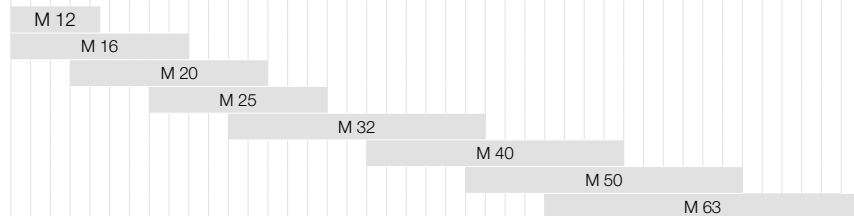

# HUMMEL | K-Counter nuts

**Material** SB / PA  
**Continuous operating temperature** -20 °C to +40 °C (SB)  
 -40 °C to +100 °C (PA)  
**Colour** grey (RAL 7035)



IG	H	mm	mm	Pack size	Part No. grey	igus® Part No.
M 12 x 1.5	5	17	5	1.262.1200.50	MAT0179500	
M 16 x 1.5	5	22	5	1.262.1600.50	MAT0179501	
M 20 x 1.5	6	27	5	1.262.2000.50	MAT0179502	
M 25 x 1.5	7	36	5	1.262.2500.50	MAT0179503	
M 32 x 1.5	7	41	5	1.262.3200.50	MAT0179504	
M 40 x 1.5	7	50	5	1.262.4000.50	MAT0179505	
M 50 x 1.5	8	60	5	1.262.5000.50	MAT0179506	
M 63 x 1.5	8	75	5	1.262.6300.50	MAT0179507	

# HUMMEL | Cable glands HSK-M

**Material** Brass, nickel-plated  
**Clamping insert** PA  
**Moulded seal** NBR  
**O ring** NBR  
**Protection class** IP 68 – 10 bar / IP 69K  
 within the specified Clamping range only  
**Continuous operating temperature** -40 °C to +100 °C



AG	mm	GL	H	mm	mm	Pack size	Part No.	igus® Part No.
M 12 x 1.5	3 - 6.5	6.5	19	14	5	1.609.1200.50	MAT0179476	
M 12 x 1.5	2 - 5	6.5	19	14	5	1.609.1200.51	MAT01712328	
M 16 x 1.5	4 - 8	6	21	17 / 19	5	1.609.1600.50	MAT0179477	
M 16 x 1.5	2 - 6	6	21	17 / 19	5	1.609.1600.51	MAT01712329	
M 16 x 1.5	5 - 10	6	22	20	5	1.609.1611.50	MAT01712330	
M 20 x 1.5	6 - 12	6	23	22	5	1.609.2000.50	MAT0179478	
M 20 x 1.5	5 - 9	6	23	22	5	1.609.2000.51	MAT01712331	
M 20 x 1.5	10 - 14	6	24	24	5	1.609.2016.50	MAT0179562	
M 25 x 1.5	13 - 18	7	26	30	5	1.609.2500.50	MAT0179479	
M 25 x 1.5	9 - 16	7	26	30	5	1.609.2500.51	MAT01711769	
M 32 x 1.5	18 - 25	8	31	40	5	1.609.3200.50	MAT0179480	
M 32 x 1.5	13 - 20	8	31	40	5	1.609.3200.51	MAT01712332	
M 40 x 1.5	22 - 32	8	37	50	5	1.609.4000.50	MAT0179481	
M 40 x 1.5	20 - 26	8	37	50	5	1.609.4000.51	MAT01712333	
M 50 x 1.5	32 - 38	9	37	57	5	1.609.5000.50	MAT0179482	
M 50 x 1.5	25 - 31	9	37	57	5	1.609.5000.51	MAT01712334	
M 63 x 1.5	37 - 44	10	38	64 / 68	5	1.609.6300.50	MAT0179483	
M 63 x 1.5	29 - 35	10	38	64 / 68	5	1.609.6300.51	MAT01712335	

Cable diameter in mm

1 2 3 4 5 6 7 8 9 10 11 12 13 14 15 16 17 18 19 20 21 22 23 24 25 26 27 28 29 30 31 32 33 34 35 36 37 38 39 40 41 42 43 44 45

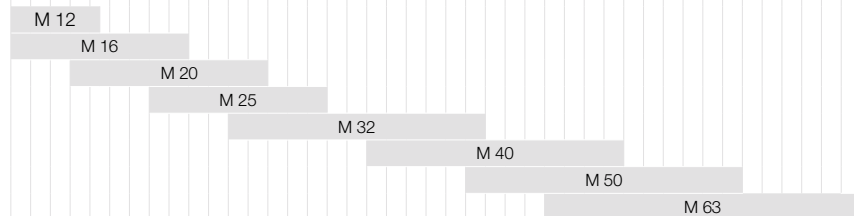

# HUMMEL | M Counter nuts

**Material** Brass, nickel-plated



IG	H	mm	mm	Pack size	Part No.	igus® Part No.
M 12 x 1.5	2.8	15	5	1.161.1200.50	MAT0179484	
M 16 x 1.5	2.8	19	5	1.161.1600.50	MAT0179485	
M 20 x 1.5	3.0	23	5	1.161.2000.50	MAT0179486	
M 25 x 1.5	3.5	29	5	1.161.2500.50	MAT0179488	
M 32 x 1.5	4.0	36	5	1.161.3200.50	MAT0179488	
M 40 x 1.5	4.5	45	5	1.161.4000.50	MAT0179489	
M 50 x 1.5	5.5	55	5	1.161.5000.50	MAT0179490	
M 63 x 1.5	6.0	70	5	1.161.6300.50	MAT0179491	

# HUMMEL | Cable glands HSK-M-EMV

**Material** Brass, nickel-plated  
**Clamping insert** PA  
**Moulded seal** NBR  
**O ring** NBR  
**Protection class** IP 68 – 10 bar / IP 69K  
 within the specified Clamping range only  
**Continuous operating temperature** -40 °C to +100 °C

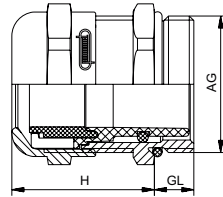

AG	mm	GL	H	mm	mm	Pack size	Part No.	igus® Part No.
M 12 x 1.5	3 - 6.5	6.5	19	14	5	1.691.1200.50	MAT0179508	
M 12 x 1.5	2 - 5	6.5	19	14	5	1.691.1200.51	MAT01712336	
M 16 x 1.5	5 - 10	6	22	20	5	1.691.1600.50	MAT0179509	
M 16 x 1.5	3 - 7	6	22	20	5	1.691.1600.51	MAT01712337	
M 20 x 1.5	10 - 14	6	23	24	5	1.691.2000.50	MAT0179510	
M 20 x 1.5	7 - 12	6	23	24	5	1.691.2000.51	MAT01712338	
M 25 x 1.5	13 - 18	7	24	30	5	1.691.2500.50	MAT0179511	
M 25 x 1.5	9 - 16	7	24	30	5	1.691.2500.51	MAT01712339	
M 32 x 1.5	18 - 25	8	31	40	5	1.691.3200.50	MAT0179512	
M 32 x 1.5	13 - 20	8	31	40	5	1.691.3200.51	MAT01712340	
M 40 x 1.5	22 - 32	8	37	50	5	1.691.4000.50	MAT0179513	
M 40 x 1.5	20 - 26	8	37	50	5	1.691.4000.51	MAT01712341	
M 50 x 1.5	32 - 38	9	37	57	5	1.691.5000.50	MAT0179514	
M 50 x 1.5	25 - 31	9	37	57	5	1.691.5000.51	MAT01712342	
M 63 x 1.5	37 - 44	10	38	64 / 68	5	1.691.6300.50	MAT0179515	
M 63 x 1.5	29 - 35	10	38	64 / 68	5	1.691.6300.51	MAT01712343	

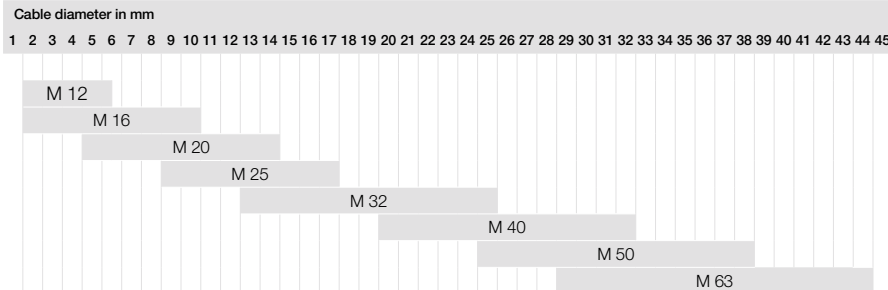

# HUMMEL | HSK-EMV Industry standard

## HSK-M-EMV

Flexible overlapping clamping splines prevent the form seal from being pulled out of the fitting

The internal sealing edge results in a superior seal between the splined Nylon clamping insert and the nickel-plated brass body.

Patented 360° grounding. The internal O-Ring, which results in a perfect contact between braided shield of cable and fitting.

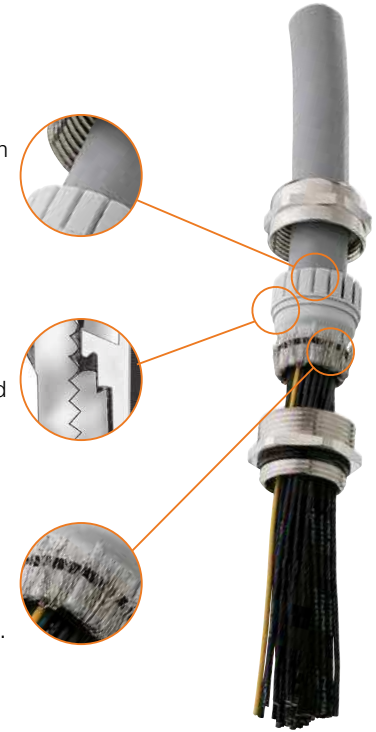

## HSK-M-EMV-D

Flexible overlapping clamping splines prevent the form seal from being pulled out of the fitting.

Metallised spline insert provides electrical conductivity.

Flexible contact points allow contact with variable braid diameters.

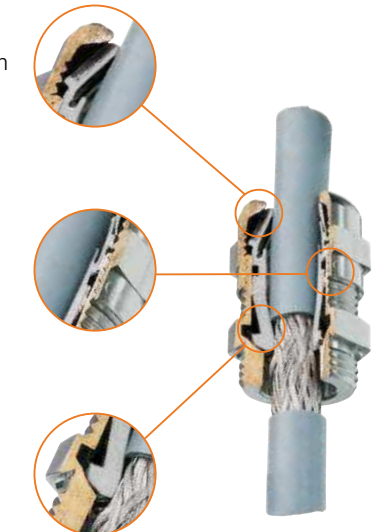

## HUMMEL | Cable glands HSK-M-EMV-D

<b>Material</b>	Brass, nickel-plated
<b>Clamping insert</b>	Metal coated PA
<b>Moulded seal</b>	NBR
<b>O ring</b>	NBR
<b>Protection class</b>	IP 68 – 10 bar / IP 69K within the specified Clamping range only
<b>Continuous operating temperature</b>	-40 °C to +100 °C



AG	mm	GL	H	mm	mm	Pack size	Part No.	igus® Part No.
M 12 x 1.5	3 - 6.5	6.5	25	14	5	1.631.1200.50	MAT0179524	
M 16 x 1.5	5 - 10	6	32	20	5	1.631.1600.50	MAT0179525	
M 20 x 1.5	10 - 14	6	33	24	5	1.631.2000.50	MAT0179526	
M 25 x 1.5	13 - 18	7	39	30	5	1.631.2500.50	MAT0179527	
M 32 x 1.5	18 - 25	8	45	40	5	1.631.3200.50	MAT0179528	
M 40 x 1.5	24 - 32	8	51	50	5	1.631.4000.50	MAT0179529	
M 50 x 1.5	32 - 38	9	57.5	57	5	1.631.5000.50	MAT0179530	
M 63 x 1.5	37 - 44	10	52	64 / 68	5	1.631.6300.50	MAT0179531	

## HUMMEL | EMV-Counter nuts

<b>Material</b>	Brass, nickel-plated
-----------------	----------------------



IG	H	mm	S	mm	Pack size	Part No.	igus® Part No.
M 12 x 1.5	2.8	15	0.7	5	1.167.1200.50	MAT0179516	
M 16 x 1.5	2.8	19	0.7	5	1.167.1600.50	MAT0179517	
M 20 x 1.5	3.0	24	0.7	5	1.167.2000.50	MAT0179518	
M 25 x 1.5	3.5	30	0.7	5	1.167.2500.50	MAT0179519	
M 32 x 1.5	4.5	36	0.7	5	1.167.3200.50	MAT0179520	
M 40 x 1.5	5.0	46	0.7	5	1.167.4000.50	MAT0179521	
M 50 x 1.5	5.0	60	0.7	5	1.167.5000.50	MAT0179522	
M 63 x 1.5	6.0	70	0.7	5	1.167.6300.50	MAT0179523	

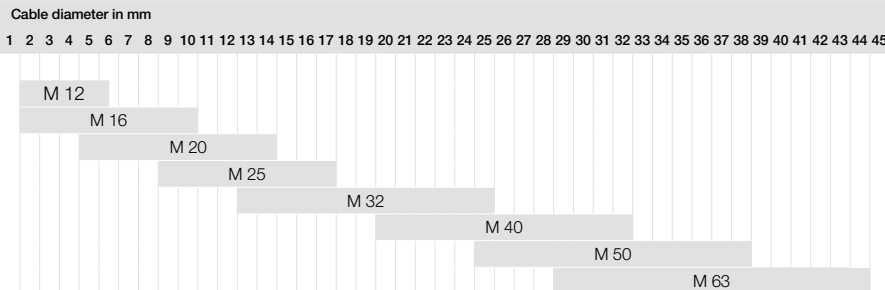

# igus<sup>®</sup> chainfix

Strain relief

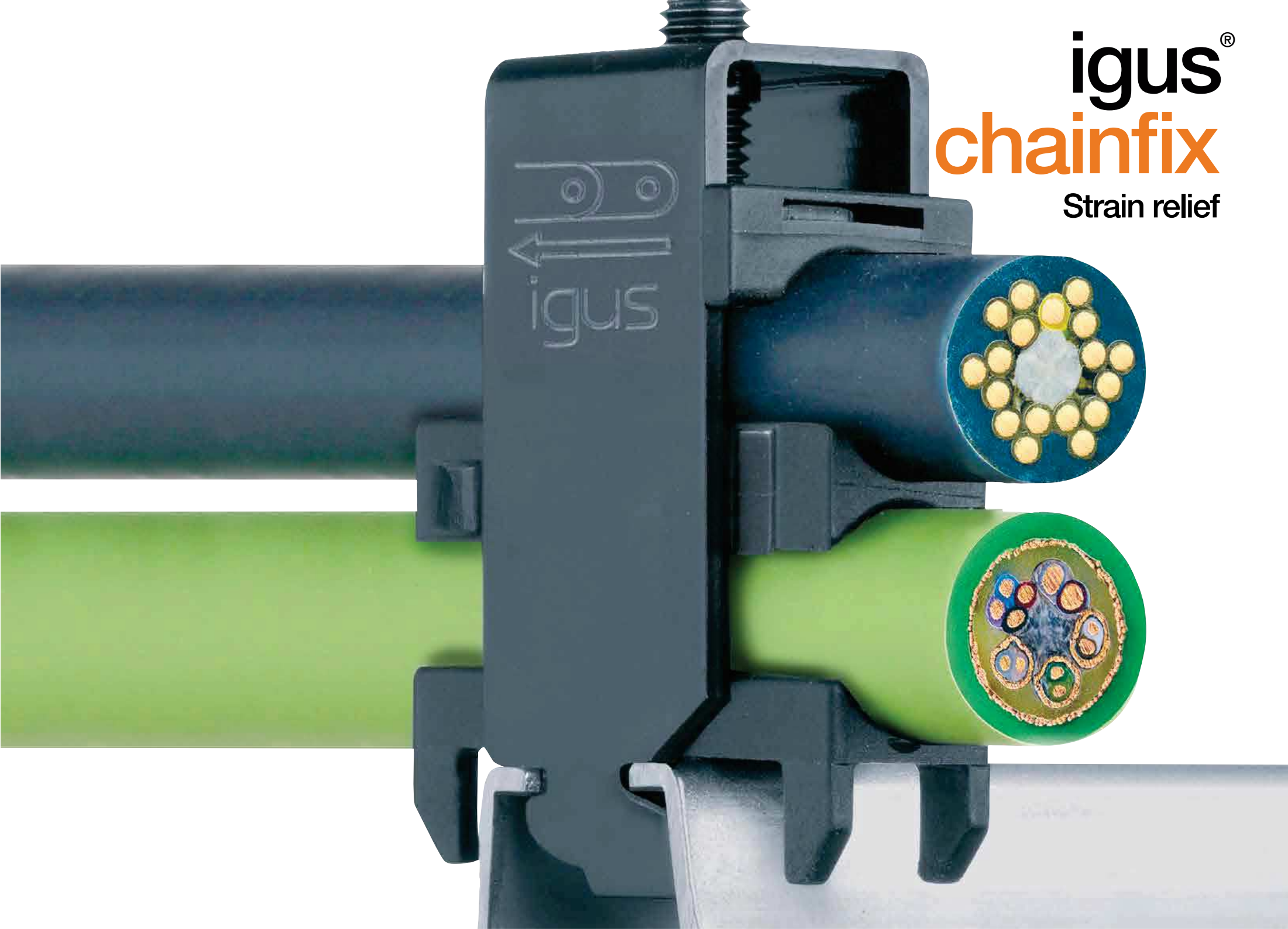



# igus® chainfix- strain relief. Flexible and quickly assembled.

Strain relief from igus® specifically developed for use in e-chains® and dynamic applications. The combination of chainflex® cable materials in contact with the polymer strain relief components of igus® chainfix are designed for long cable life and maximum holding power. For a wide variety of applications igus® is the best solution in terms of cost and benefits, from the best chainfix strain relief for long travels or harsh use to chainfix Nuggets, for simple and inexpensive strain relief solutions. igus® chainfix strain relief components are proven in real use by customers around the world.



## chainfix strain-relief systems | Overview

### Clamps, steel or stainless steel - For maximum tensile strength ▶ Page 750



Clamps, saddles and bases	ø [mm]
CFX* Single, double, triple standard clamps	6-42
CFXL* Single, double, triple clamps with wide base for maximum tensile forces	6-42
Clamp elements - saddles and bases	6-42
chainfix Multi-Clamps*	6-12

### C-profiles ▶ Page 756



Standard C-profiles and C-profiles for heavy-duty applications
Standard C-profiles part no. CF.92.42. (to be integrated into KMA!)
C-profiles part no. CF.92.52. With increased retention force (assembly outside e-chain®)

### Universal tiewrap clamps, screw or clip mounted ▶ Page 758



chainfix tiewrap plates	ø [mm]
Option 1A: Tiewrap plates as single part "Series 2000" + cable tiewraps	
Option 1B: Tiewrap plates as single part "Series 3000" + cable tiewraps	
Cable tiewraps as single part	max. 36

### Tiewrap plates, with clip-on connection for the C-profile ▶ Page 760



chainfix tiewrap plates
Option 2: Tiewrap plates with clip-on connection for the C-profile
Option 3: Integrated strain relief for E2 e-tubes - Series R
Option 4: Tiewrap plates for fixed crossbars
Option 5: Tiewrap plates for opening crossbars

### Clips - High tensile strength, modular clip-on strain relief ▶ Page 762



chainfix clips	ø [mm]
Option 1: for all e-chains® with C-profiles and also suitable for assembly in the KMA mounting brackets	4-24
Option 2: Clip-on strain relief for opening crossbars	4-24

### Strain relief separators - with integrated teeth ▶ Page 764



chainfix strain relief separator
Separator with integrated strain relief - for easy strain relief with cable ties

### Nuggets - for top hat rail and C-profile ▶ Page 766



chainfix nuggets	ø [mm]
Option 1: simple and universal cable fixation, for diameter with Ø 20 mm and Ø 30 mm	≤ 30
Option 2: Fastening through clipping onto standard top hat rail	≤ 20

### Strain relief blocks - special strain reliefs for hoses ▶ Page 767



Blocks	ø [mm]
Conventional igus® blocks - strain relief for hoses	4,3-14
CFB polymer strain relief connector system, for many cables in a confined space	

\*Standard material: galvanised steel. Also available as stainless steel-version (material stainless steel: 1.4301/AISI 304)









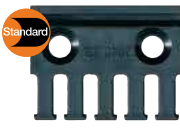

Available from stock. Delivery time\* from 24h or same day!

\*Delivery time refers the time until the product is shipped (after verifying technical feasibility)



3D-CAD, configurators, PDF, applications ▶ [www.igus.eu/chainfix](http://www.igus.eu/chainfix)



igus® chainfix- strain relief system							
Parameters		<b>CFX Clamps</b>	<b>Tiewrap plates screwed, clip-on</b>	<b>Clips for C-profile or clip-on</b>	<b>Nuggets Strain relief nuggets</b>	<b>Strain relief separators</b>	<b>CFB strain relief connector system</b>
	<b>Recommended standard for the following e-chains®:</b>	<b>E4, E6, for all KMA* with C-profile</b> <small>Polymer metal mounting bracket</small>	<b>easychain®, E2/000, E2 e-tubes, E4, E6</b>	<b>E4, E6, for all KMA* with C-profile</b> <small>Polymer metal mounting bracket</small>	<b>For all KMAs* with C-profile, top-hat rails</b> <small>Polymer metal mounting bracket</small>	<b>E2/000, E2 e-tubes, E6, T3</b>	<b>E4, E6, for all KMA* with C-profile</b> <small>Polymer metal mounting bracket</small>
	<b>When to use this igus® strain relief system:</b>	Standard for high accelerations, loads and demanding applications. For many cables, large cable Ø, stacked cables. For long travels, cranes, offshore, machine tools, high speed, hydraulic cables. If modularity is required.	Standard for many applications with medium acceleration. For unsupported, gliding, hanging and standing applications in general machinery and machine tools. For cables next to each other. Also available as single parts, for example for cabinets, etc.	Cost-effective, space-saving strain relief for many applications with medium accelerations. For stacked cables, or cables with the same diameters.	Cost-effective, fast strain relief for simple applications with confined space requirements at medium accelerations. Also available as single parts for rigid linings, such as in cabinets, etc.	Combination of separator and strain relief, ideal for confined space requirements. For applications with medium accelerations. For smaller cable diameter. Ideal for e-tubes. For machine tools and automation.	Space-saving, modular strain relief with many cables in confined spaces. For applications with high accelerations and loads, e.g. machine tools.
	<b>When not to use it:</b>	No limitation	For large cable diameters	Under high loads	Under high loads	Under high loads	No limitation
<b>Features</b>							
<b>Assembly time index</b>		+	+	+ -	+ -	+	+ -
<b>Adjustable tensile strength</b>		++	-	+ -	-	-	+
<b>Price Index</b>		●●●	●●●	●●●	●●●	●●●	●●●
<b>Modularity</b>		yes	yes	yes	yes	yes	yes (special fabrication)
<b>Dynamics</b>		high to very high	high	medium	high	high	high to very high

Price Index  
 ●●● Low price category  
 ●●● Medium price category  
 ●●● Highest price category

++ = best suitability  
 + = good suitability  
 + - = suitable  
 - = conditionally suitable

All clamps were tightened with 1Nm.  
 Cable tie wraps tightened by hand.

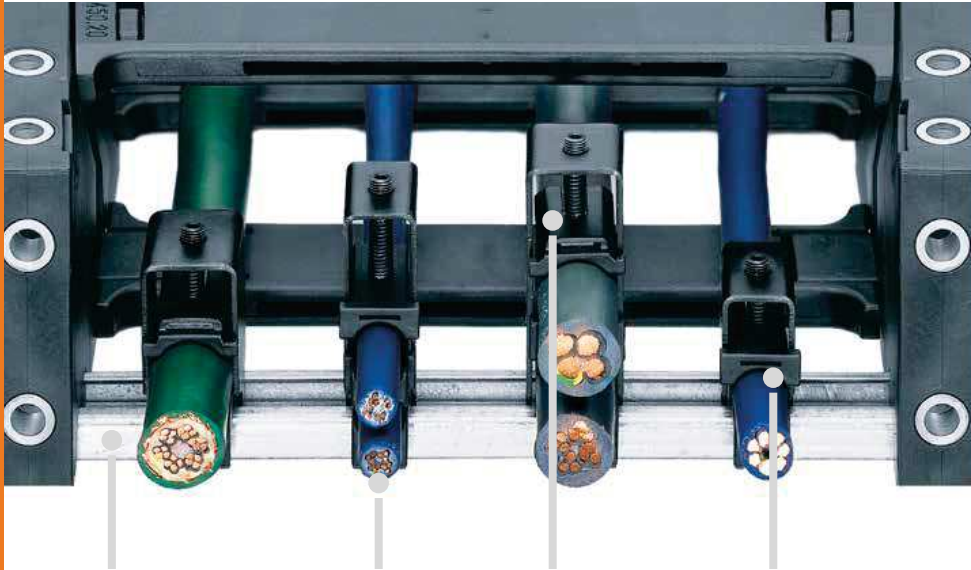

Can be integrated into KMA mounting brackets

For up to three cables stacked

Reduced installation height, space saving

Excellent durability for dynamic applications

#### chainfix clamps – fitted safely and even faster

- Integration with KMA mounting brackets and C-profile host-option
- Easy to read part no. and lateral marking of the correct installation direction
- Reduced installation height due to optimal housing height (compared to conventional clamps up to 15 mm)
- Space- and time-saving assembly
- Delivery options for complete systems with cables and preassembled strain relief
- Improved base for easy fit on the C-profile
- Setscrews tightened with hex wrench, for easy installation
- Durability for dynamic applications through improved stacker elements: optimised stacker saddles, captive by retaining lugs
- The long contact surface of the stacker elements improves the clamp's stability
- The high rigidity of the stacker elements significantly increases the reliability
- Built-in ribs to the stacker elements - no slipping of cables within the strain relief
- Optional: CFXL clamps with increased holding force for heavy-duty applications (CFXL clamps are always assembled IN FRONT of the e-chain® - CANNOT be integrated into KMA mounting brackets with C-profile host-option!)



Available from stock. Delivery time\* from 24 hrs or same day!

\*Delivery time refers to the time until the product is shipped (after verifying technical feasibility)

#### Product range and materials

- Steel clamp: clamp and screw black painted steel
- Stainless steel clamp: clamp and screw: blank (material 1.4301/AISI 304)
- Stacker elements: bottom saddle and stacker saddle (material igumid G)
- C-profiles: steel (material galvanised steel) or stainless steel (material 1.4301/AISI 304) available

#### Installation height

If the e-chain® glides on itself for long travels, the screw heads of the strain relief at the fixed end of the e-chain® must have a distance of at least 10 mm below the top of the e-chain®. As a consequence of this, many strain relief elements described here may not be suitable for use at the fixed end on gliding e-chains®. For unsupported e-chains® these strain relief elements can be used safely.



#### Please note!

- The cables should ideally be fixed at both ends of the e-chain®. **The minimum should be to be fixed at the moving end of the e-chain®.**
- When using chainfix clamps on C-profiles in the mounting bracket for the Series: E4.32/H4.32/R4.32, 280/290 R770, 2828/2928/R7728 a shortened bottom saddle must be used. For shortened bottom saddles supplement part no. with index "K" = Example: Part no. CFX12.1K



For the following igus® series

#### E2/000

● 2400/2500/2450/2480

● 2600/2700/2650/2680

● 3400/3500/3450/3480

#### E4.1

● E4.32/H4.32/R4.32

● E4.42/H4.42/R4.42

● E4.56/H4.56/R4.56

● E4.80/H4.80/R4.80

#### E4/light

● 14040/14140/18840

● 14240/14340

● 14550/14650/19050

● 15050/15150/19850

● 15250/15350

#### E4/00

● 280/290/R770

● 380/390/R780

● 400/410/R880

#### E4/4

● 2828/2928/R7728

● 3838/3938/R7838

● 4040/4140/R8840

● 5050/5150/R9850

#### E6

● E6.40

● E6.52 / R6.52

● E6.62

● E6.80L

● E6.80



CFX - chainfix housing with reduced height



KMA mounting bracket with integrated C-profile and chainfix clamps



Save both time and space during installation of igus® chainfix clamps

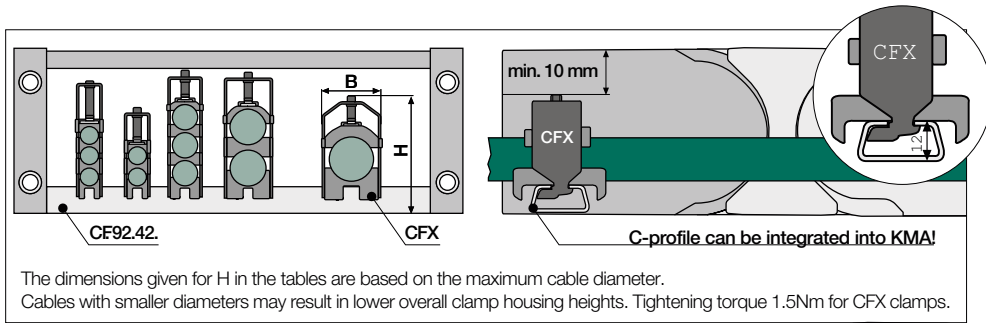

The dimensions given for H in the tables are based on the maximum cable diameter. Cables with smaller diameters may result in lower overall clamp housing heights. Tightening torque 1.5Nm for CFX clamps.



**CFX** | Standard clamps with standard base  
Suitable for C-profiles CF.92.42.XX - Can be integrated into KMA with C-profile-option!

**CFX - Single clamp housing, incl. bottom saddles**

Part no. steel	Part no. stainless steel*	ø [mm]	B <sup>+2</sup> [mm]	H [mm]	Part no. steel	Part no. stainless steel*	ø [mm]	B <sup>+2</sup> [mm]	H [mm]
CFX12.1	CFX12.1.E	06 - 12	16	54	CFX26.1	CFX26.1.E	22 - 26	30	67
CFX14.1	CFX14.1.E	12 - 14	18	50	CFX30.1	CFX30.1.E	26 - 30	34	71
CFX16.1	CFX16.1.E	14 - 16	20	52	CFX34.1	CFX34.1.E	30 - 34	38	75
CFX18.1	CFX18.1.E	16 - 18	22	54	CFX38.1	CFX38.1.E	34 - 38	42	79
CFX20.1	CFX20.1.E	18 - 20	24	56	CFX42.1	CFX42.1.E	38 - 42	46	83
CFX22.1	CFX22.1.E	20 - 22	26	58					

\*Material stainless steel: 1.4301/AISI 304



**CFX - Double clamp housing, incl. bottom and stacker saddles**

Part no. steel	Part no. stainless steel*	ø [mm]	B <sup>+2</sup> [mm]	H [mm]	Part no. steel	Part no. stainless steel*	ø [mm]	B <sup>+2</sup> [mm]	H [mm]
CFX12.2	CFX12.2.E	06 - 12	16	72	CFX22.2	CFX22.2.E	20 - 22	26	90
CFX14.2	CFX14.2.E	12 - 14	18	74	CFX26.2	CFX26.2.E	22 - 26	30	109
CFX16.2	CFX16.2.E	14 - 16	20	78	CFX30.2	CFX30.2.E	26 - 30	34	117
CFX18.2	CFX18.2.E	16 - 18	22	82	CFX34.2	CFX34.2.E	30 - 34	38	125
CFX20.2	CFX20.2.E	18 - 20	24	86					

\*Material stainless steel: 1.4301/AISI 304

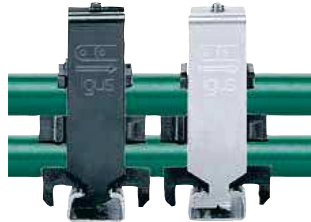

**CFX - Triple clamp housing, incl. bottom and stacker saddles**

Part no. steel	Part no. stainless steel*	ø [mm]	B <sup>+2</sup> [mm]	H [mm]	Part no. steel	Part no. stainless steel*	ø [mm]	B <sup>+2</sup> [mm]	H [mm]
CFX12.3	-	06 - 12	16	100	CFX18.3	-	16 - 18	22	108
CFX14.3	-	12 - 14	18	96	CFX20.3	-	18 - 20	24	114
CFX16.3	-	14 - 16	20	102	CFX22.3	-	20 - 22	26	120

\*Material stainless steel: 1.4301/AISI 304



Suitable C-profiles for CFX clamps part no. CF.92.42. ► Page 732

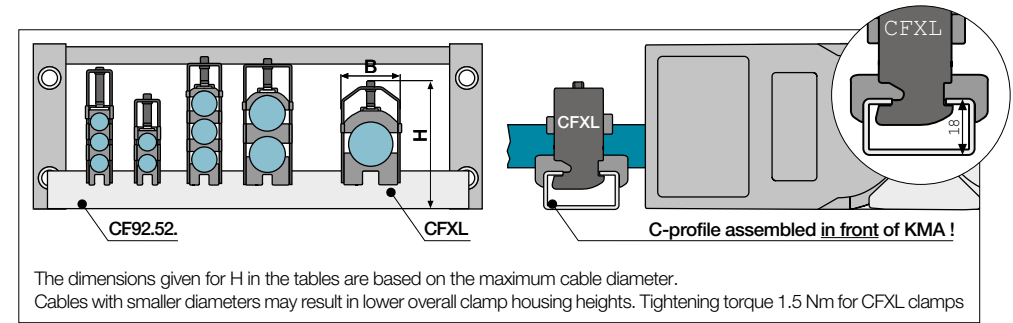

The dimensions given for H in the tables are based on the maximum cable diameter. Cables with smaller diameters may result in lower overall clamp housing heights. Tightening torque 1.5 Nm for CFXL clamps.

**CFXL** | Clamps with wide base for increased holding power  
Suitable for C-profiles CF.92.52.XX - C-profile assembled in front of KMA! NO KMA-integration!

**CFXL - Single clamp housing, incl. bottom saddles**

Part no. steel	Part no. stainless steel*	ø [mm]	B <sup>+2</sup> [mm]	H [mm]	Part no. steel	Part no. stainless steel*	ø [mm]	B <sup>+2</sup> [mm]	H [mm]
CFXL12.1	CFXL12.1.E	06 - 12	16	60	CFXL26.1	CFXL26.1.E	22 - 26	30	73
CFXL14.1	CFXL14.1.E	12 - 14	18	56	CFXL30.1	CFXL30.1.E	26 - 30	34	77
CFXL16.1	CFXL16.1.E	14 - 16	20	58	CFXL34.1	CFXL34.1.E	30 - 34	38	81
CFXL18.1	CFXL18.1.E	16 - 18	22	60	CFXL38.1	CFXL38.1.E	34 - 38	42	85
CFXL20.1	CFXL20.1.E	18 - 20	24	62	CFXL42.1	CFXL42.1.E	38 - 42	46	89
CFXL22.1	CFXL22.1.E	20 - 22	26	64					

\*Material stainless steel: 1.4301/AISI 304



**CFXL - Double clamp housing, incl. bottom and stacker saddles**

Part no. steel	Part no. stainless steel*	ø [mm]	B <sup>+2</sup> [mm]	H [mm]	Part no. steel	Part no. stainless steel*	ø [mm]	B <sup>+2</sup> [mm]	H [mm]
CFXL12.2	CFXL12.2.E	06 - 12	16	78	CFXL22.2	CFXL22.2.E	20 - 22	26	86
CFXL14.2	CFXL14.2.E	12 - 14	18	80	CFXL26.2	CFXL26.2.E	22 - 26	30	115
CFXL16.2	CFXL16.2.E	14 - 16	20	84	CFXL30.2	CFXL30.2.E	26 - 30	34	123
CFXL18.2	CFXL18.2.E	16 - 18	22	86	CFXL34.2	CFXL34.2.E	30 - 34	38	131
CFXL20.2	CFXL20.2.E	18 - 20	24	92					

\*Material stainless steel: 1.4301/AISI 304



**CFXL - Triple clamp housing, incl. bottom and stacker saddles**

Part no. steel	Part no. stainless steel*	ø [mm]	B <sup>+2</sup> [mm]	H [mm]	Part no. steel	Part no. stainless steel*	ø [mm]	B <sup>+2</sup> [mm]	H [mm]
CFXL12.3	-	06 - 12	16	106	CFXL18.3	-	16 - 18	22	114
CFXL14.3	-	12 - 14	18	102	CFXL20.3	-	18 - 20	24	120
CFXL16.3	-	14 - 16	20	108	CFXL22.3	-	20 - 22	26	126

\*Material stainless steel: 1.4301/AISI 304

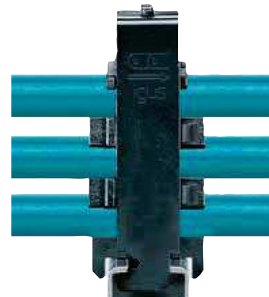

Suitable C-profiles for CFXL clamps part no. CF.92.52. ► Page 732

**Characteristics of igus® chainfix clamps - stacker elements**

- Built-in ribs for security of cables within the strain relief
- Optimized double-trough, captive by ❶ locking spring and with ❷ spring groove for a simplified and precise installation
- Conventional stacker saddles
- Long contact surface improves the clamp's stability
- More secure due to high stiffness
- Suitable for CFX-and CFXL-clamps



Bottom saddles to slide into the clamp housing as single part

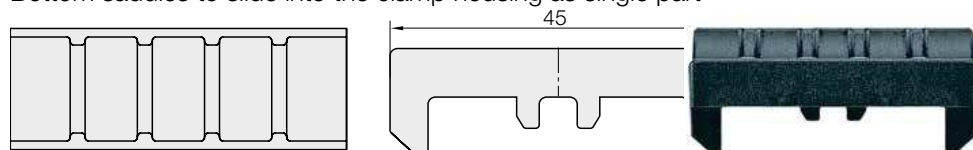

Conventional stacker saddles for all for all double and triple clamps as single part

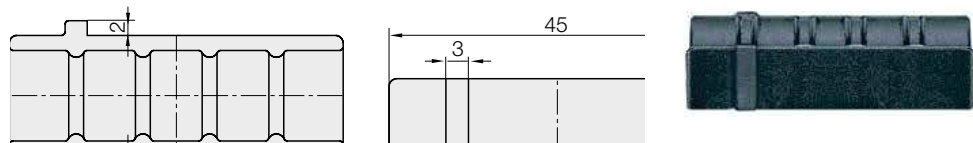

**NEW** in this catalogue!

Optimised stacker saddles for all double and triple clamps as single part

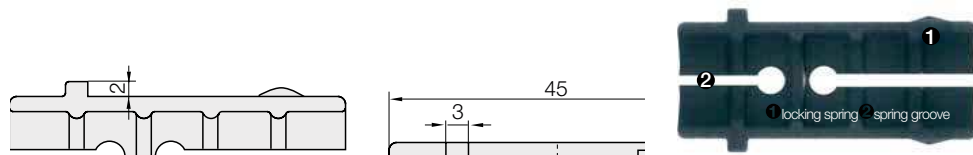

Part no. clamp	Part no. bottom saddle	GDXX stacker saddle	GD.XX.C stacker saddle	Cable Ø [mm]	Part no. clamp	Part no. bottom saddle	CDXX stacker saddle	CD.XX.C stacker saddle	Cable Ø [mm]
CFX/CFXL12.X	CG12	CD12	CD.12.C*	06 - 12	CFX/CFXL26.X	CG26	CD26	CD.26.C*	22 - 26
CFX/CFXL14.X	CG14	CD14	CD.14.C*	12 - 14	CFX/CFXL30.X	CG30	CD30	CD.30.C*	26 - 30
CFX/CFXL16.X	CG16	CD16	CD.16.C*	14 - 16	CFX/CFXL34.X	CG34	CD34	CD.34.C*	30 - 34
CFX/CFXL18.X	CG18	CD18	CD.18.C	16 - 18	CFX/CFXL38.X	CG38	-	-	34 - 38
CFX/CFXL20.X	CG20	CD20	CD.20.C*	18 - 20	CFX/CFXL42.X	CG42	-	-	38 - 42
CFX/CFXL22.X	CG22	CD22	CD.22.C*	20 - 22					



Please note: When using chainfix clamps on C-profile in the mounting bracket for Series E4.32/H4.32/R4.32, 280/290/R770, 2828/2928/R7728, 28/29/R77 a shortened bottom saddle has to be used. For shortened bottom saddles supplement part no. with index "K" = Example: Part no. CFX12.1K

**Characteristics of igus® chainfix multi-clamps**

- Now more flexible options of the proven chainfix strain relief elements with more components
- Universal strain relief – more assembly options
- Saves both time and space during installation
- Compact and modular
- For small outer diameters
- Cost-effective



CFX12 | Multi-clamps, universal strain relief

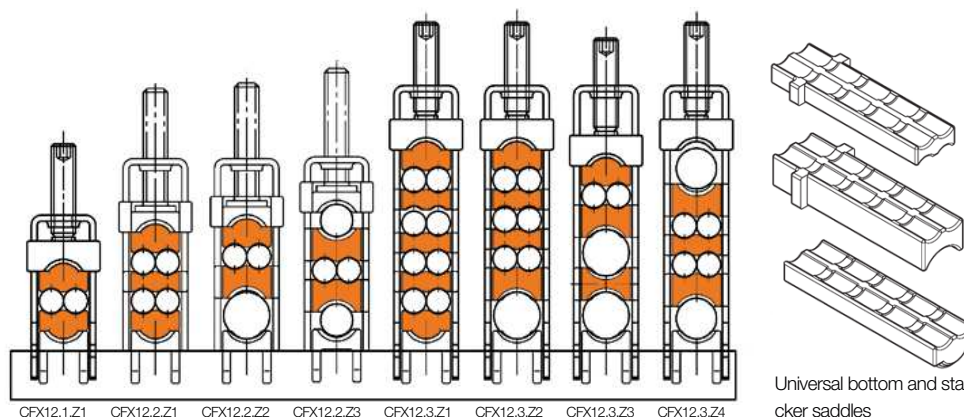

Part no. series	Part no. stacker saddles - single parts				For cables Ø max. [mm]
CFX12.1.Z1	X (2-piece)	-	-	-	6
CFX12.2.Z1	X (2-piece)	X (1-piece)	-	-	6
CFX12.2.Z2	X (1-piece)	-	X (1-piece)	-	6 + 12
CFX12.2.Z3	-	-	X (2-piece)	-	6 + 8
CFX12.3.Z1	X (2-piece)	X (3-piece)	-	-	6
CFX12.3.Z2	X (1-piece)	X (2-piece)	X (1-piece)	-	6 + 12
CFX12.3.Z3	X (1-piece)	-	X (1-piece)	X (1-piece)	6 + 12
CFX12.3.Z4	-	X (1-piece)	X (2-piece)	-	6 + 10

Standard material: galvanised steel. For the stainless steel version (material 1.4301/AISI 304) supplement part no. with Index "E" = example: part no. CFX.12.3.Z1.E

**Standard C-profiles part no. CF.92.42.XX**

- For all igus® CFX clamps and KMA mounting brackets with C-profile host-option
  - Standard material: galvanised steel part no. CF.92.42.XX (XX=length in mm)
  - Also available as stainless steel version  
(Material: 1.4301/AISI 304)
- Please add index **.E**, example: Part no. CF.92.52.XX.XX.E
- Length tolerances of  $\pm 1$  mm possible!

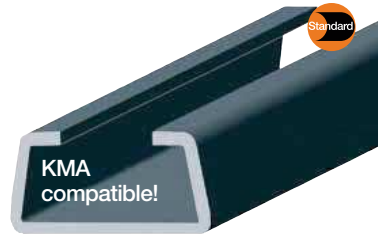

**Standard C-profile part no. CF.92.42. | For standard applications**

Can be integrated into KMA with C-profile host-option!

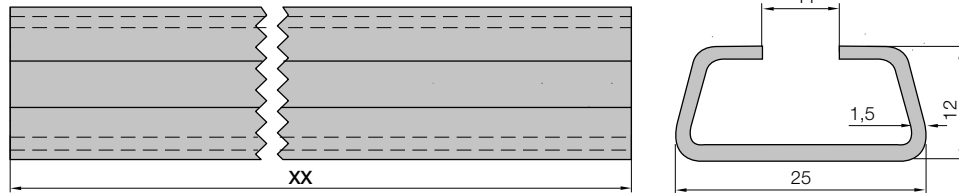

**Optional | For heavy-duty applications**

**C-profiles part no. CF.92.52.XX**

- For all igus® CFXL clamps
  - With increased holding power - even for harsh applications
  - Standard material galvanised steel part no. CF.92.52.XX (XX = length in mm)
  - Also available as stainless steel version  
(Material: 1.4301/AISI 304)
- Please add Index **.E**, example: Part no. CF.92.52.XX.E
- Length tolerances of  $\pm 5$  mm possible!



**C-profile part no. CF.92.52. With increased holding power for tough applications**

Assembly in front of the e-chain® - **NO** integration into KMA!

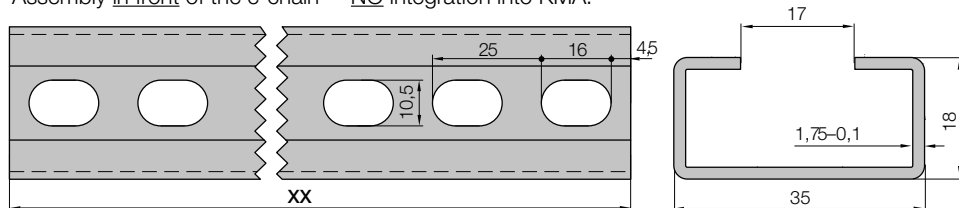

Available from stock. **Delivery time\* from 24 hrs or same day!**

\*Delivery time refers to the time until the product is shipped (after verifying technical feasibility)



igus® tensile strength test with CFX clamps

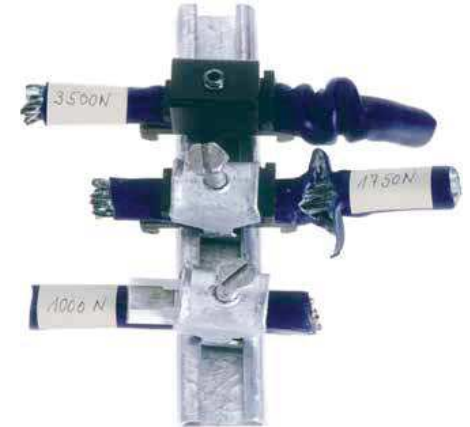

igus® test: Comparison of three different strain reliefs - Result: Triple tensile strength of igus® chainfix clamps compared to conventional products.

**igus® strain relief devices are tested under real conditions, taking various parameters into account**

Whether under the influence of fluids like water or oil, or at different ambient temperatures. The interaction of chainfix systems with different jacket materials of cables and hoses of course plays a big role in the in-house tests. **Detailed information about the tests: chainfix strain relief parameter overview ► Page 724**



Tensile strength tests with chainflex® cables



Tensile strength tests of igus® clamps with cable tiewraps

**Characteristics of igus® chainfix tiewrap plates - Series 2000**

**Option 1A.: Tiewrap plates as single parts**

- Available as individual component
- Screwed on KMA\* with C-profile (\*polymer metal mounting bracket)
- Can be clipped onto the mounting bracket
- Single part for the manufacturing of switchgear cabinets or for the assembly of machines
- Accessory for igus® e-chain systems®

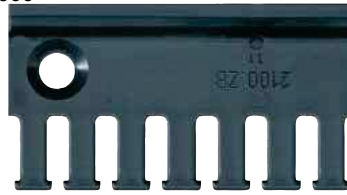

**Series 2000 | Tiewrap plate as single part**

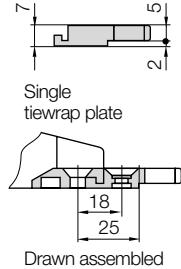
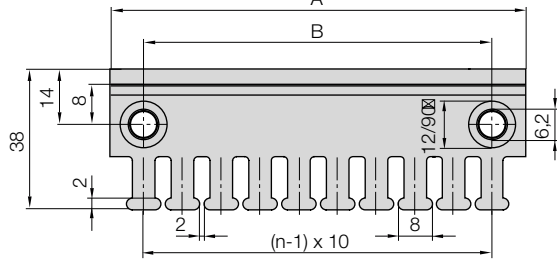

**For the following igus® series**

- easychain®**
- E200/Z200
- E2/000**
- 1400/1500/1450/1480
  - 2400/2500/2450/2480
- E2 e-tubes**
- R117/R118
  - R48
- E4.1**
- E4.28
- E4/00**
- 220 (2050.Z)
- E6**
- E6.29/R6.29
  - E6.35
  - E6.40

Tiewrap plate	n Number of teeth	Dim. A [mm]	Dim. B [mm]	Dim. C [mm]	Centre bore -- = no / + = yes
2020.ZB	3	30	15	-	-
2030.ZB	4	40	20	-	-
2040.ZB	5	50	30	-	-
2050.ZB	6	60	40	-	-
2070.ZB	8	80	60	-	-
2090.ZB (= 2030.ZB + 2040.ZB)	9	90	-	-	-
2100.ZB	10	100	80	-	-
2125.ZB (= 2050.ZB + 2050.ZB)	12	120	-	-	-

**Cable tiewraps separately**

Cable tiewraps (100-piece bag)	Width x length [mm]	Maximum Ø	Pull force resistance [N]
CFB.001	4.8 x 150	36	222 N

**Available from stock. Delivery time\* from 24 hrs or same day!**

\*Delivery time refers to the time until the product is shipped (after verifying technical feasibility)

**Characteristics of igus® chainfix tiewrap plates - Series 3000**

**Option 1B.: Tiewrap plates as individual parts**

- Available as individual component
- Screwed on KMA\* with C-profile (\*polymer metal mounting bracket)
- Can be clipped onto the mounting bracket
- Single part for the manufacturing of switchgear cabinets or for the assembly of machines
- Accessory for igus® e-chain systems®



**Series 3000 | Tiewrap plate as single part**

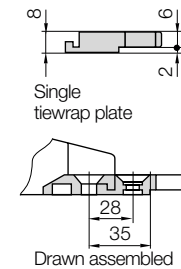
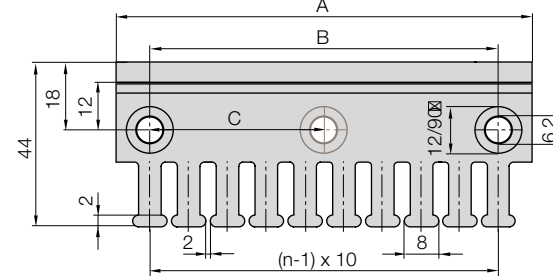

**For the following igus® series**

- easychain®**
- E26/Z26
  - E300/Z300
- E2/000**
- 2600/2700/2650/2680
  - 3400/3500/3450/3480
- E4.1**
- E4.32/H4.32/R4.32
  - E4.42/H4.42/R4.42
  - E4.56/H4.56/R4.56
  - E4.80/H4.80/R4.80
- E4/00**
- 1640
  - 800
  - 840
- E4/light**
- 14040/14140/18840
  - 14240/14340
  - 14550/14650/19050
  - 15050/15150/19850
- E4/00**
- 15250/15350
- E4/00**
- 280/290/R770
  - 380/390/R780
  - 400/410/R880
  - 600/601/R608

Tiewrap plate	n Number of teeth	Dim. A [mm]	Dim. B [mm]	Dim. C [mm]	Centre bore -- = no / + = yes
3050.ZB	5	50	30	-	-
3075.ZB	7	75	55	-	-
3100.ZB	10	100	80	-	-
3115.ZB	11	115	95	-	-
3125.ZB	12	125	105	-	-
3150.ZB	15	150	130	-	-
3175.ZB	17	175	155	-	-
3200.ZB	20	200	180	90	+
3225.ZB	22	225	205	102.5	+
3250.ZB	25	250	230	115	+

**Cable tiewraps**

Cable tiewraps (100-piece bag)	Width x length [mm]	Maximum Ø	Pull force resistance [N]
CFB.001	4.8 x 150	36	222 N

**Available from stock. Delivery time\* from 24 hrs or same day!**

\*Delivery time refers to the time until the product is shipped (after verifying technical feasibility)



### Characteristics of igus® chainfix tiewrap plates Option 2: With clip-on connection for the C-profile

- Can be clipped into the KMA C-profile
- Easy to assemble without any screws
- Easy to remove with screwdriver yet secure
- Single part for the manufacturing of switchgear cabinets or for the assembly of machines
- Accessory for igus® e-chain systems®

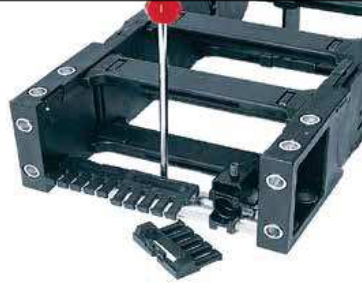

### Option 2 | Tiewrap plate with clip-on connection for C-profile



For all mounting brackets with C-profile!

Part no.	Width [mm]	Number of teeth
3050.ZC	50	5
3075.ZC	75	7

### Characteristics of igus® chainfix tiewrap plates Option 3: Integrated strain relief for E2 e-tubes - Series R

- Strain relief integrates completely into the e-tube
- Easy to assemble without any screws
- Single part for the manufacturing of switchgear cabinets or for the assembly of machines
- Accessory for igus® e-chain systems®



### Option 3 | Tiewrap plate for E2 e-tubes of series R



For the following igus® series  
► See table

Part no.	Width [mm]	Number of teeth	For series
3050.Z	50	5	R68
3075.Z	75	7	R68
5850.Z	46	4	R58

### Characteristics of igus® chainfix tiewrap plates Option 4: For fixed crossbars or option 5: For opening crossbars

- Can be clipped onto fixed and opening crossbars
- In case of many harnessed cables
- Dual level strain relief
- If the KMA is too small for the C-profile
- Easy to assemble without any screws
- Accessory for igus® e-chain systems®



### Option 4 | Tiewrap plate for fixed crossbars



For the following igus® series  
► See table

Part no.	Width [mm]	Number of teeth	For series
2050.Z	60	6	E/Z200, 2400/2500, 2600/2700
3050.Z	50	5	3400/3500
3075.Z	74	7	3400/3500

### Option 5 | Tiewrap plate for opening crossbars



For the following igus® series  
► See table

Part no.	Width [mm]	Number of teeth	For series
2050.Z	60	6	E4/H4/R4.28, 220, 2650
3035.ZS	35	3	3400/3500
3050.ZS	50	5	3400/3500
3075.ZS	75	7	3400/3500
3850.ZS	48	5	E4/H4/R4.32, E4/H4/R4.42, 280/290/R770, 380/390/R780, 2828/2928/R7728, 3838/3938/R7838, 14240/14340, 15250/15350, E6.52, E6.62
4550.ZS	48	5	E4/H4/R4.56, E4/H4/R4.80, 400/410/R880, 4040/4140/R8840, 5050/5150/R9850, 14040/14140/18840, 14550/14650/19050, 15050/15150/19850, E6.80L, E6.80, 1640/1608
4575.ZS	74	7	E4/H4/R4.56, E4/H4/R4.80, 400/410/R880, 4040/4140/R8840, 5050/5150/R9850, 14040/14140/18840, 14550/14650/19050, 15050/15150/19850, E6.80L, E6.80, 1640/1608



Available from stock. Delivery time\* from 24 hrs or same day!

\*Delivery time refers to the time until the product is shipped (after verifying technical feasibility)



Available from stock. Delivery time\* from 24 hrs or same day!

\*Delivery time refers to the time until the product is shipped (after verifying technical feasibility)

**Characteristics of igus® chainfix clips**  
**Option 1: Modular clip-on strain relief for C-profile**

- Available for all igus® e-chains® with C-profiles
- Also suitable for assembly in the KMA mounting brackets
- Polymer, for cable diameters ranging from 4 mm to 24 mm
- Quick assembly without any tools
- 2 to 3 layers on top of one another possible
- Each layer can be detached and changed later on



Option 1 | Clip-on strain relief for C-profile

**Clamp - Part no. CFC-XX-M**

ø Cable [mm]	Part no. clamp	Dim. A [mm]	Dim. B [mm]	Dim. C [mm]	Dim. D [mm]	Dim. E [mm]
04 - 08 mm	<b>CFC-08-M</b>	14.5	13	5.5	7.5	30
08 - 12 mm	<b>CFC-12-M</b>	23.7	24	10	14	36
12 - 16 mm	<b>CFC-16-M</b>	32.4	32.5	13.6	18.9	42
16 - 20 mm	<b>CFC-20-M</b>	43.2	39.1	17.6	11.5	45
20 - 24 mm	<b>CFC-24-M</b>	54	49	22	27	50

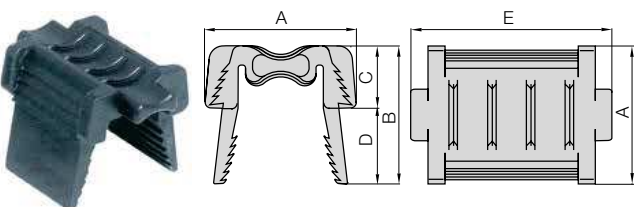

**Bottom part - Part no. CFC-XX-C**

ø Cable [mm]	Part no. clamp	Dim. A [mm]	Dim. B [mm]	Dim. C [mm]	Dim. D [mm]	Dim. E [mm]
04 - 08 mm	<b>CFC-08-C</b>	14.5	12.5	5.5	7	24
08 - 12 mm	<b>CFC-12-C</b>	23.8	18	11	7	28
12 - 16 mm	<b>CFC-16-C</b>	32.4	23.6	13.6	10	32
16 - 20 mm	<b>CFC-20-C</b>	43.2	24.6	17.6	7	36
20 - 24 mm	<b>4-C</b>	54	29	22	7	39

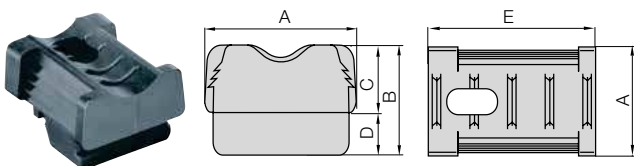

**For all mounting brackets with C-profile!**

**Available from stock. Delivery time\* from 24 hrs or same day!**

\*Delivery time refers the time until the product is shipped (after verifying technical feasibility)

**Characteristics of igus® chainfix clips**  
**Option 2: Clip-on strain relief for opening crossbars**

- Available for all igus® e-chains® with opening crossbars Part no. 450.XX.
- Polymer, for cable diameters from 8 mm to 12 mm
- Quick assembly without any tools
- 2 to 3 layers on top of one another possible
- Each layer can be detached and changed later on



Option 2 | Clip-on strain relief for opening crossbars

**Clamp - Part no. CFC-XX-M**

ø Cable [mm]	Part no. clamp	Dim. A [mm]	Dim. B [mm]	Dim. C [mm]	Dim. D [mm]	Dim. E [mm]
08 - 12 mm	<b>CFC-12-M</b>	23.7	24	10	14	36

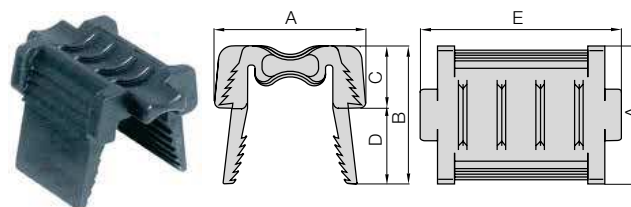

**Bottom part - Part no. CFC-XX-B**

ø Cable [mm]	Part no. clamp	Dim. A [mm]	Dim. B [mm]	Dim. C [mm]	Dim. D [mm]	Dim. E [mm]
08 - 12 mm	<b>CFC-12-B</b>	23.8	21	13	8	38

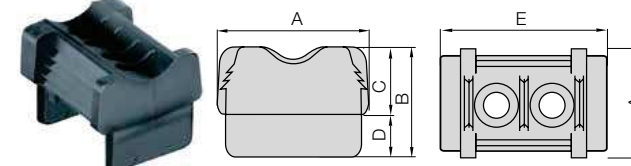

**For the following igus® series**

- E4.1**
  - E4.56/H4.56/R4.56
  - E4.80/H4.80/R4.80
  - 1640
  - 840
- E4/light**
  - 14040/14140
  - 14550/14650
  - 15050/15150
- E4/00**
  - 400/410
  - 640
- E4/4**
  - 4040/4140
  - 5050/5150
- E6**
  - E6.80L
  - E6.80

**Available from stock. Delivery time\* from 24 hrs or same day!**

\*Delivery time refers the time until the product is shipped (after verifying technical feasibility)

**Characteristics of igus® strain relief separators**  
**Separator with integrated strain relief teeth**

- To be used either at the first or last e-chain® link
- For restricted space conditions
- Easy to assemble without any screws
- The number "n" depends on the selection of the cables (diameter, type) and the available space



Strain relief separator | With integrated teeth

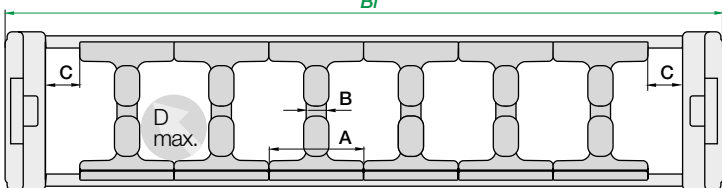

For series	Part no. strain relief separator	Number of teeth	Dim. A [mm]	Dim. B [mm]	Dim. C [mm]	Dim. D [mm]
1400/1500	▶ 21.1.Z	2	10	4	–	6
2400/2500	▶ 2020.Z	2	10	4	–	6
2450/2480	▶ 2020.ZR	2	10	4	–	6
2600/2700	▶ 262.Z	3	10	4	–	6
3400/3500	▶ 301.Z	3	18	4	–	14
3450/3800	▶ 34501.Z	3	14	4	–	10
R157/R158	▶ 1585.01.Z	3	22	4	–	18
R167/R168	▶ 1685.01.Z	4	22	4	–	18
R48	▶ 481.ZR	2	10	3.5	10	6.5
E4.21	▶ T2103.Z	2	8	4	1	4
E4.28	▶ 28.Z	2	10	4	–	6
R4.28	▶ 28.ZT	2	10	4	15	6
T3.29	▶ E6.29.02.Z	2	8	4	1	4
E6.29/E61.29	▶ E6.29.02.Z	2	8	4	1	4
E6.35	▶ E6.35.02.Z	3	8	4	1	4
E6.40	▶ E6.40.02.Z	3	13	4	–	8

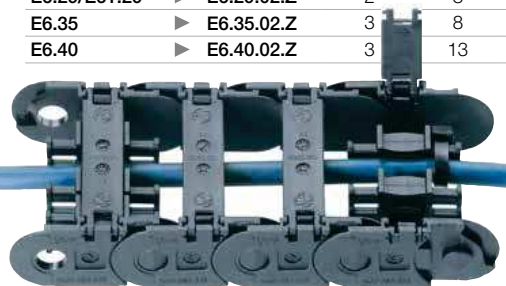









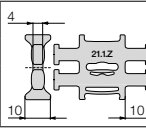

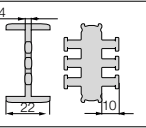

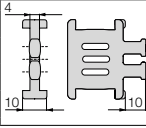

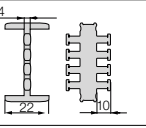

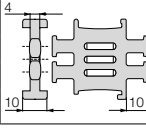

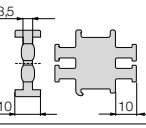

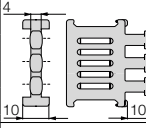

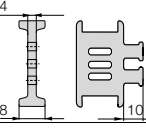

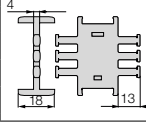

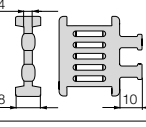
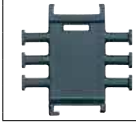
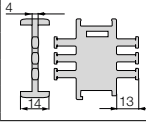

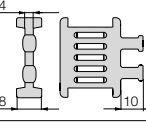
Strain relief separators are fitted either at the first or last e-chain® link. For an intermediate strain relief they can be assembled inside the e-chain®

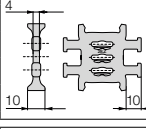
 **For the following igus® series**

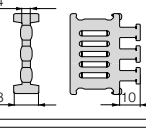
- E2/000**
- 1400/1500
  - 2400/2500
  - 2450/2480
  - 2600/2700
  - 3400/3500
  - 3450/3480
- E2 e-tubes**
- R157/R158
  - R167/R168
  - R48
- E4.1**
- E4.21
  - E4.28/R4.28
- T3**
- T3.29
- E6**
- E6.29
  - E6.35
  - E6.40
- E6.1**
- E61.29

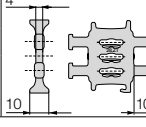
Strain relief separators | **Product range overview**

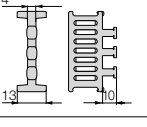
		<b>1400/1500</b> E2/000 e-chains® unassembled 21.1.Z assembled 21.1.Z.1			<b>R157/R158</b> E2 e-tubes unassembled 1585.01.Z assembled 1586.01.Z
		<b>2400/2500</b> E2/000 e-chains® unassembled 2020.Z assembled 2120.Z			<b>R167/R168</b> E2 e-tubes unassembled 1685.01.Z assembled 1686.01.Z
		<b>2450/2480</b> E2/000 e-tubes unassembled 2020.ZR assembled 2120.ZR			<b>R48</b> E2 e-tubes unassembled 481.ZR assembled 482.ZR
		<b>2600/2700</b> E2/000 e-chains® unassembled 262.Z assembled 263.Z			<b>E4.21</b> E4.1 e-chains® unassembled T2103.Z assembled T2113.Z
		<b>3400/3500</b> E2/000 e-chains® unassembled 301.Z assembled 311.Z			<b>T3.29</b> T3 e-chains® unassembled E6.29.02.Z assembled E6.29.12.Z
		<b>3450/3480</b> E2/000 e-tubes unassembled 34501.Z assembled 34511.Z			<b>E6.29/E61.29</b> E6/E6.1 e-chains® unassembled E6.29.02.Z assembled E6.29.12.Z
		<b>E4.28</b> E4.1 e-chains® unassembled 28.Z assembled 28.Z.1			<b>E6.35</b> E6 e-chains® unassembled E6.35.02.Z assembled E6.35.12.Z
		<b>R4.28</b> E4.1 e-tubes unassembled 28.ZT assembled 28.ZT.1			<b>E6.40</b> E6 e-chains® unassembled E6.40.02.Z assembled E6.40.12.Z

 Available from stock. **Delivery time\* from 24 hrs or same day!**

\*Delivery time refers to the time until the product is shipped (after verifying technical feasibility)

### Characteristics of igus® chainfix Nuggets

#### Option 1: C-profile and option 2: top hat rail

- Option 1: Universal cable fixation in C-profile
- Option 2: Clip onto a top hat rail
- Simple strain relief - harnessed cable tiewraps
- Very small space requirement
- Easy to assemble without any screws and tools
- Adjustable to any e-chain® filling



#### Option 1 | chainfix nuggets for C profile

For C-profiles	Part no. nugget	Ø Cable max. [mm]	Dim. A [mm]
92.42.../92.42...E	CFN.20	20	10.8
92.52.../92.52...E	CFN.30.52	30	16.4

#### For all mounting brackets with C-profile!

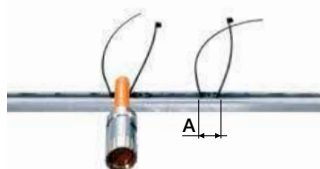

#### Option 2 | chainfix nuggets for top-hat rail

For top hat rail	Part no. nugget	Ø Cable max. [mm]	Dim. A [mm]
Top hat rail 35	CFN.20.N35	20	20.0

#### For standard rails 35 (top-hat rails) !

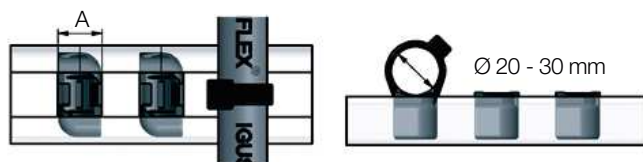

### Characteristics of the special strain relief system for hoses igus® blocks

- Modular, space-saving system
- No hose damage
- Combination of hoses and cables possible
- Hose diameters from 4.3 14 mm
- Easy to assemble without any screws and tools
- Adjustable to any e-chain® filling



#### Block | Strain relief for hoses

Part no. block modules	Hose Ø [mm]	Number of hoses	Width [mm]
CFS 4,3	4.3	4 - 12	27.5
CFS 6	6	3 - 6	27.5
CFS 9	9	2	27.5
CFS 55,9	9	5	55.0
CFS 10	10	2	27.5
CFS 12	12	2	27.5
CFS 14	14	1	27.5

Part no. base plate	Part no. cover plate	Width [mm]
CFS U75	CFS P75	75
CFS U102,5	CFS P102,5	102.5
CFS U130	CFS P130	130
CFS U185	CFS P185	185
CFS U212	CFS P212	212.5
CFS U240	CFS P240	240
CFS U295	CFS PD295	295

Part no. spacer	Height [mm]
CFS D 16	16
CFS D 12	12
CFS D295	16

#### Please contact us!

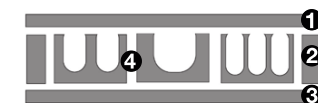

- 1 Cover plate
- 2 Spacers
- 3 Base plate
- 4 Grid-dimensions modules  
B = 27.5 mm, H = 16 mm

The modules accommodate hoses from 4.3 to 14 mm, 3 x 4.3 mm hoses can be fitted on top of each in module CFS 4.3 and 2 hoses can be fitted directly on top of each other in one notch using module CFS 6. The modules have a width of 27.5 mm, are inserted into the base plate and then fastened in position with M4 countersunkhead screws. The exception is module CFS 55.9 which offers the capacity for 5 x 9 mm hoses with twice the width. The base plate and cover plate are available in widths ranging from 75 to 240mm. The height of the spacers and modules is 16mm. Several layers can be installed directly above one another.



Available from stock. **Delivery time\* from 24 hrs or same day!**

\*Delivery time refers to the time until the product is shipped (after verifying technical feasibility)



Delivery time upon request, customer-specific fabrication!