

Light design, high dynamics, cost-effective



e-chains® | E4.38L | Crossbars every link (openable along inner and outer radius, from both sides)
e-tubes | R4.38L | Fully enclosed (lids openable along inner and outer radius, from both sides)

Part No.	Part No.	Bi	Ba	E4.38L	R4.38L	Part No.	Part No.	Bi	Ba	E4.38L	R4.38L
e-chains®	e-tubes	[mm]	[mm]	[kg/m]	[kg/m]	e-chains®	e-tubes	[mm]	[mm]	[kg/m]	[kg/m]
E4.38L.050.R.0	R4.38L.050.R.0	50	66	≈ 1.13	≈ 1.20	E4.38L.225.R.0	-	225	241	≈ 1.97	-
E4.38L.062.R.0	-	62	78	≈ 1.19	-	E4.38L.237.R.0	-	237	253	≈ 2.05	-
E4.38L.075.R.0	R4.38L.075.R.0	75	91	≈ 1.26	≈ 1.38	E4.38L.250.R.0	R4.38L.250.R.0	250	266	≈ 2.11	≈ 2.65
E4.38L.087.R.0	-	87	103	≈ 1.30	-	E4.38L.262.R.0	-	262	278	≈ 2.15	-
E4.38L.100.R.0	R4.38L.100.R.0	100	116	≈ 1.37	≈ 1.60	E4.38L.275.R.0**	-	275	291	≈ 2.22	-
E4.38L.105.R.0	-	105	121	≈ 1.39	-	E4.38L.287.R.0**	-	287	303	≈ 2.30	-
E4.38L.112.R.0	-	112	128	≈ 1.44	-	E4.38L.300.R.0	R4.38L.300.R.0**	300	316	≈ 2.36	≈ 3.00
E4.38L.125.R.0	R4.38L.125.R.0	125	141	≈ 1.50	≈ 1.75	E4.38L.312.R.0**	-	312	328	≈ 2.40	-
E4.38L.137.R.0	-	137	153	≈ 1.55	-	E4.38L.325.R.0**	-	325	341	≈ 2.47	-
E4.38L.150.R.0	R4.38L.150.R.0	150	166	≈ 1.65	≈ 1.92	E4.38L.337.R.0**	-	337	353	≈ 2.55	-
E4.38L.162.R.0	-	162	178	≈ 1.69	-	E4.38L.350.R.0**	-	350	366	≈ 2.57	-
E4.38L.175.R.0	R4.38L.175.R.0	175	191	≈ 1.74	≈ 2.10	E4.38L.362.R.0**	-	362	378	≈ 2.60	-
E4.38L.187.R.0	-	187	203	≈ 1.80	-	E4.38L.375.R.0**	-	375	391	≈ 2.65	-
E4.38L.200.R.0	R4.38L.200.R.0	200	216	≈ 1.86	≈ 2.29	E4.38L.387.R.0**	-	387	403	≈ 2.76	-
E4.38L.212.R.0	-	212	228	≈ 1.90	-	E4.38L.400.R.0**	-	400	416	≈ 2.83	-

**Width available upon request. Delivery time upon request.

*Radius available upon request. Please consult igus® for delivery time. 1) Radius not available for e-tubes

Available bend radii

R [mm] | 063¹⁾ | 075¹⁾ | 100¹⁾ | 125 | 150 | 175 | 200 | 250 | 300 | 350*

Complete Part No. with required radius (R). Example:

E4.38L.100.150.0 = crossbars every link / R4.38L.100.150.0 = fully enclosed

Unsupported applications | Short travels

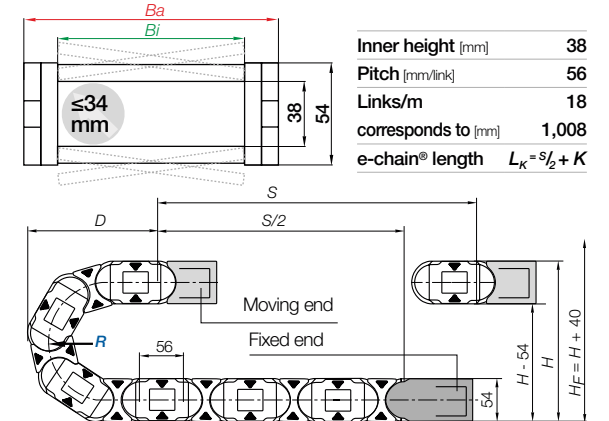
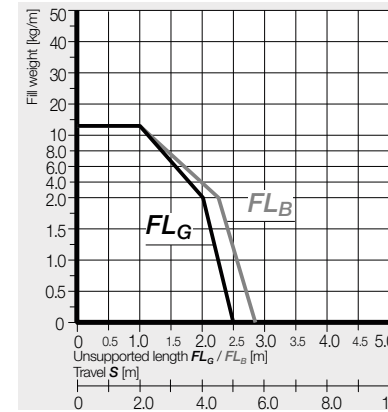

R	063 ¹⁾	075 ¹⁾	100 ¹⁾	125	150	175	200	250	300	350*
H	180	204	254	304	354	404	454	554	654	754
D	174	186	211	236	261	286	311	361	411	461
K	310	350	430	505	585	665	745	900	1,055	1,215

The required clearance height: $H_F = H + 40\text{mm}$ (with 2.0kg/m fill weight)

*Radius available upon request. Please consult igus® for delivery time. 1) Radius not available for e-tubes

Gliding applications | For travel lengths from 10m to max. 80m

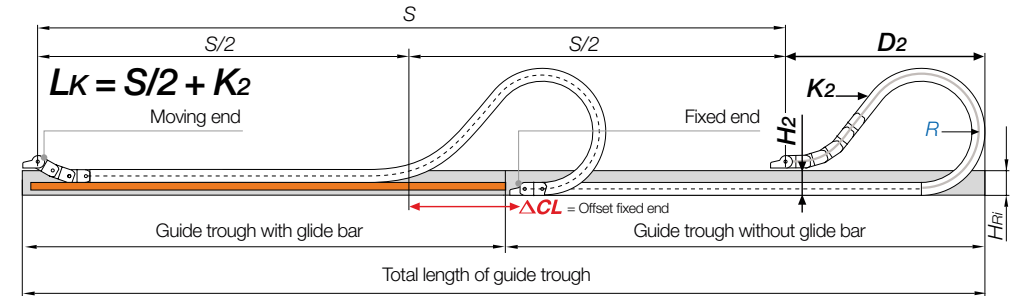

Note: We recommend the project planning of such a system to be carried out by igus®.

In case of travels between 5 and 10m we recommend an e-chain® with a longer unsupported length.

R	063 ¹⁾	075 ¹⁾	100 ¹⁾	125	150	175	200	250 ²⁾	300 ²⁾	350 ²⁾
H ₂	180	204	96	96	96	96	96	-	-	-
D ₂	174	186	370	470	500	655	770	-	-	-
K ₂	310	350	616	784	896	1,120	1,288	-	-	-
ΔACL	-	-	160	210	240	370	460	-	-	-

1) Radius not available for e-tubes 2) Radius not suitable for long travel applications. Please consult igus®.

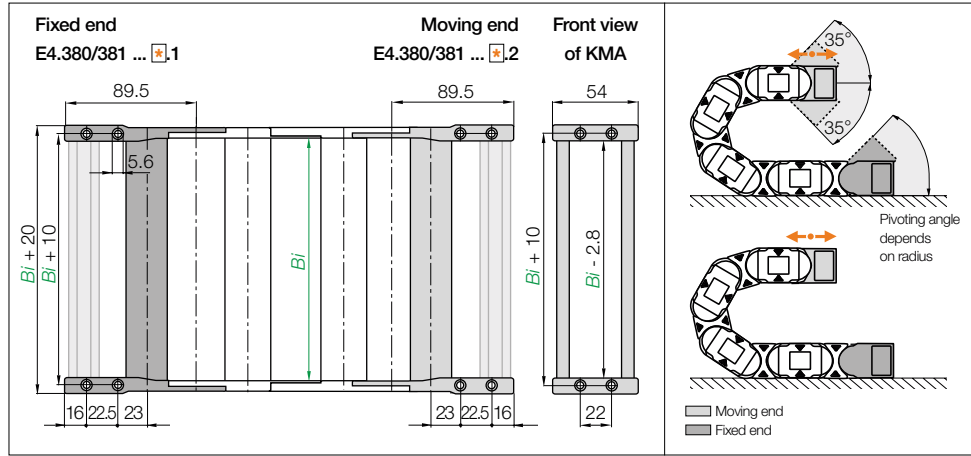

KMA pivoting | Recommended for unsupported and gliding applications
KMA locking | Recommended for vertical hanging and standing applications

Width index	Part No. full set KMA pivoting	Part No. full set KMA locking	Bi [mm]	Width index	Part No. full set KMA pivoting	Part No. full set KMA locking	Bi [mm]
050.	E4.380.050.12.C	E4.381.050.12.C	50	225.	E4.380.225.12.C	E4.381.225.12.C	225
062.	E4.380.062.12.C	E4.381.062.12.C	62	237.	E4.380.237.12.C	E4.381.237.12.C	237
075.	E4.380.075.12.C	E4.381.075.12.C	75	250.	E4.380.250.12.C	E4.381.250.12.C	250
087.	E4.380.087.12.C	E4.381.087.12.C	87	262.	E4.380.262.12.C	E4.381.262.12.C	262
100.	E4.380.100.12.C	E4.381.100.12.C	100	275.	E4.380.275.12.C*	E4.381.275.12.C*	275
105.	E4.380.105.12.C	E4.381.105.12.C	105	287.	E4.380.287.12.C*	E4.381.287.12.C*	287
112.	E4.380.112.12.C	E4.381.112.12.C	112	300.	E4.380.300.12.C	E4.381.300.12.C	300
125.	E4.380.125.12.C	E4.381.125.12.C	125	312.	E4.380.312.12.C*	E4.381.312.12.C*	312
137.	E4.380.137.12.C	E4.381.137.12.C	137	325.	E4.380.325.12.C*	E4.381.325.12.C*	325
150.	E4.380.150.12.C	E4.381.150.12.C	150	337.	E4.380.337.12.C*	E4.381.337.12.C*	337
162.	E4.380.162.12.C	E4.381.162.12.C	162	350.	E4.380.350.12.C*	E4.381.350.12.C*	350
175.	E4.380.175.12.C	E4.381.175.12.C	175	362.	E4.380.362.12.C*	E4.381.362.12.C*	362
187.	E4.380.187.12.C	E4.381.187.12.C	187	375.	E4.380.375.12.C*	E4.381.375.12.C*	375
200.	E4.380.200.12.C	E4.381.200.12.C	200	387.	E4.380.387.12.C*	E4.381.387.12.C*	387
212.	E4.380.212.12.C	E4.381.212.12.C	212	400.	E4.380.400.12.C*	E4.381.400.12.C*	400

(KMA = polymer metal mounting bracket) For the C-profile option please add index .C

*Width available upon request. Delivery time upon request.

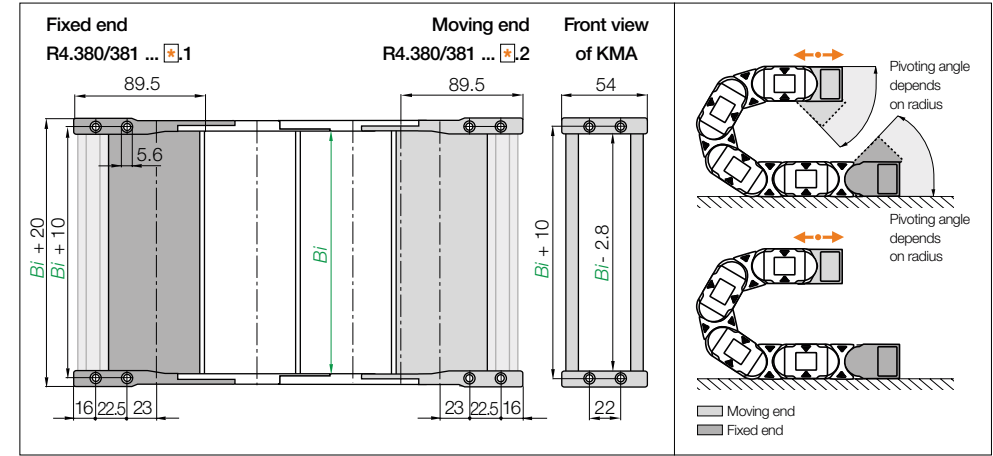

KMA pivoting | Recommended for unsupported and gliding applications
KMA locking | Recommended for vertical hanging and standing applications

Width index	Part No. full set KMA pivoting	Part No. full set KMA locking	Bi [mm]	Width index	Part No. full set KMA pivoting	Part No. full set KMA locking	Bi [mm]
050.	R4.380.050.12.C	R4.381.050.12.C	050	175.	R4.380.175.12.C	R4.381.175.12.C	175
075.	R4.380.075.12.C	R4.381.075.12.C	075	200.	R4.380.200.12.C	R4.381.200.12.C	200
100.	R4.380.100.12.C	R4.381.100.12.C	100	250.	R4.380.250.12.C	R4.381.250.12.C	250
125.	R4.380.125.12.C	R4.381.125.12.C	125	300.	R4.380.300.12.C*	R4.381.300.12.C*	300
150.	R4.380.150.12.C	R4.381.150.12.C	150				

(KMA = polymer metal mounting bracket) For the C-profile option please add index .C

*Width available upon request. Delivery time upon request.

Note: The e-chains® may end with either an inner or an outer side link. An outer side link should always be the first e-chain® link at the moving end. Please specify the index 1 (for odd) or 2 (for even) depending on an even or odd number of links required.

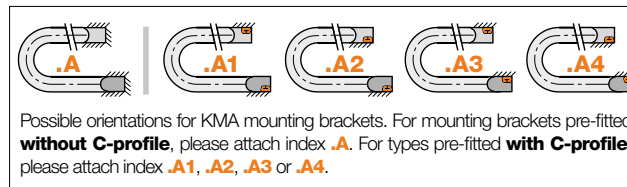
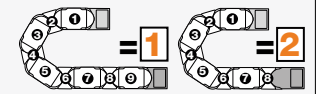

E4.380.100.2.12.C.A2 Order example

- .A... to indicate option with brackets pre-fitted
- C-profile option
- Full set
- Even numbers of links
- Width index
- Series

Strain relief e.g. clamps, tiewrap plates, nuggets and clips are available from stock. The complete chainfix range with ordering options ► From page 1392

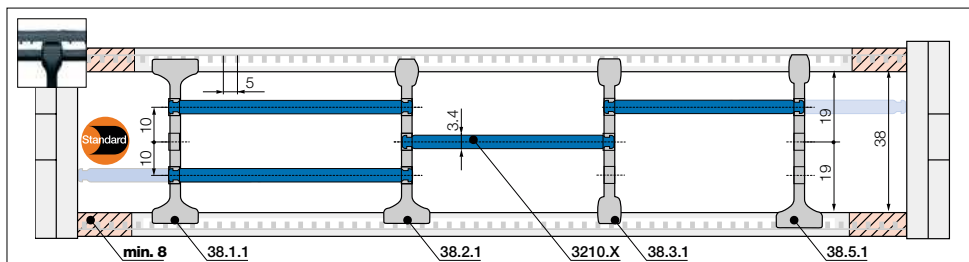

Note: Please be aware of the minimum lateral gap to the side links! **e-tube: 8mm** | **e-chain®: 8mm**
As standard separators are fitted every 2nd e-chain® link!

Standard separator, wide base

unassembled **38.1**
assembled **38.1.1**

Standard - for any application
Separator with a wide base for maximum holding force.

Separator, narrow top

unassembled **38.2**
assembled **38.2.1**

For even faster installation
Wide on one side for high holding force, narrow on opposite side for easy cable fitting.

Separator, narrow

unassembled **38.3**
assembled **38.3.1**

For small cables
Separator with a narrow base for a large number of small cables side by side. Saves space.

Notch separator for notched crossbar

unassembled **38.5**
assembled **38.5.1**

Locks securely in preset increments
Notch separator for exact positioning. Recommended for side-mounted applications.

Shelf, lockable

unassembled **3200.X**
assembled **3210.X**

Horizontal separation
Full-width shelf locks securely into separators at both ends, giving a fixed width. Can be used as full-width or partial shelf.

Shelves Width = X [mm]	X [mm]		X [mm]		X [mm]			
	unassembled	assembled	unassembled	assembled	unassembled	assembled		
050	3200.050	3210.050	125	3200.125	3210.125	225	3200.225	3210.225
075	3200.075	3210.075	150	3200.150	3210.150	250	3200.250	3210.250
100	3200.100	3210.100	175	3200.175	3210.175			
115	3200.115	3210.115	200	3200.200	3210.200			

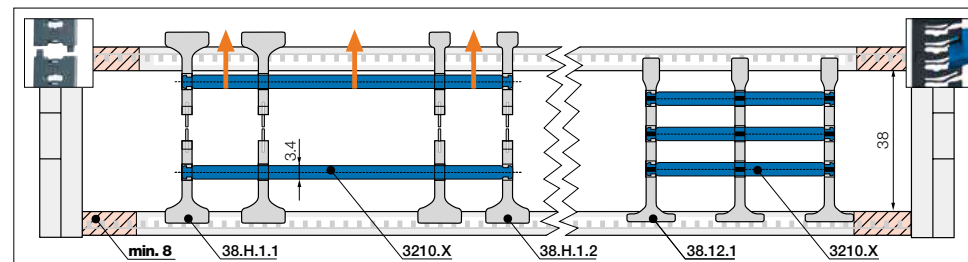

Note: Please be aware of the minimum lateral gap to the side links! **e-tube: 8mm** | **e-chain®: 8mm**
As standard separators are fitted every 2nd e-chain® link!

Split separator, wide base/top

unassembled **38.H.1**
assembled **38.H.1.1**

Split separators
In order to fill e-chains® more easily and effectively, these separators can be split in the middle. This allows easier access to middle shelf partitions. Fast assembly and easy retrofit. 2 types available: with wide or narrow top.

Split separator, narrow top

unassembled **38.H.2**
assembled **38.H.2.1**

Lean separator¹⁾

unassembled **38.12**
assembled **38.12.1**

Lean separators¹⁾
For quick fitting of shelves in several layers.
1) Note: Please combine maximum 4 lean separators with one shelf. Not suitable for side-mounted e-chains®!

With the lean separator you can quickly insert several layers of cables into the e-chain® and reduce the installation time by up to 50%²⁾.

²⁾ Lean interior separation vs. Standard separator - measured on a 4m long e-chain® fitted with 12 cables in the igus® readychain® factory



Separator with integrated strain relief teeth

- Can be integrated into the mounting bracket or placed at any point
 - Combines strain relief and interior separation, for restricted space conditions
 - Strain relief separator is easy to assemble without any screws
- Part No. 38.Z - more information ▶ From page 1424



e-chain® with openable extender crossbars

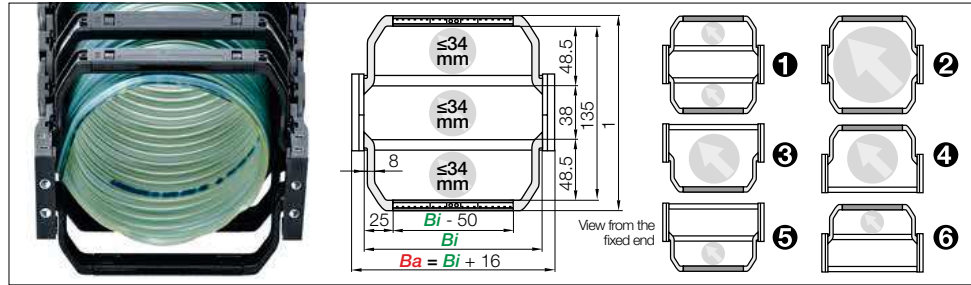

Extender crossbars with flexible width | Safe guiding for large hoses

- For guiding and protecting large hoses
- With mounting for noise dampers
- Cable-friendly design, high crossbar holding force
- The openable extender crossbars can be fitted in different ways and combinations
- Optionally openable along the inner or outer radius

Versions	Hose	Part No.
e-chain® with extender crossbar	$\emptyset \leq$ [mm]	e-chain® with extender crossbar
① Extender crossbar and standard crossbar alternating along the inner and outer radius ¹⁾	34	E4.38L.XXXHB48.R.0
② Extender crossbar on both sides along the inner and outer radius ²⁾	122	E4.38L.XXXB48.R.0
③ Extender crossbar along the outer radius ³⁾	78	E4.38L.XXXBE48.R.0
④ Extender crossbar along the inner radius ²⁾	78	E4.38L.XXXBZ48.R.0
⑤ Extender crossbar and standard crossbar alternating along the outer radius ³⁾	34	E4.38L.XXXHBE48.R.0
⑥ Extender crossbar and standard crossbar alternating along inner radius ¹⁾	34	E4.38L.XXXHBZ48.R.0

1) Minimum bend radius: R 125 2) Minimum bend radius: R 150 3) Minimum bend radius: R 063 *Width available upon request. Delivery time upon request

Bi [mm] Available inner widths

| 100 | 105 | 112 | 125 | 137 | 150 | 162 | 175 | 187 | 200 | 212 | 225 | 237 | 250 | 262 | 275* | 287* | 300 | 312* | 325* | 337* | 350* | 362* | 375* | 387* | 400*

Complete Part No. with the width index XXX of Bi and the minimum bend radius (R). Example:

E4.38L.100B48.150.0 = Bi 100 / extender crossbar on both sides along inner and outer radius / bend radius (R) 150



The E4.1L can be fitted with openable extender crossbars, which increase the size of the interior of the e-chain®. Crossbars can be fitted in various ways: from one or both sides, alternating with standard crossbars and or any combination

Aluminium support tray

- Corrosion-resistant and seawater-resistant aluminium rails with adjustable width
 - Noise-reducing glide strip integrated as standard
 - Easy installation and connection of the e-tube
 - Open design - dirt and debris fall through
- More information ► From page 1362



TUB

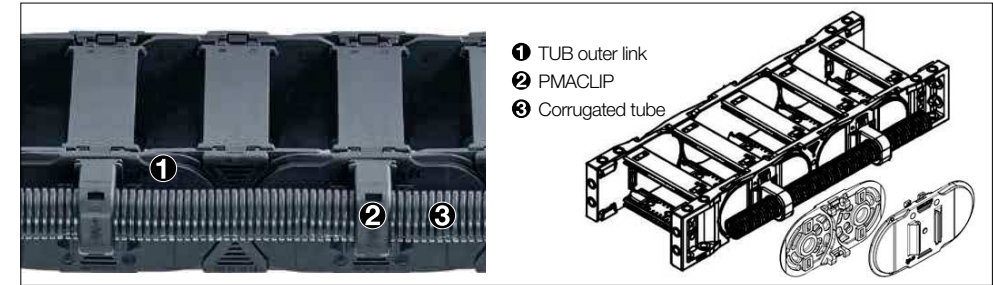

TUB | Safe guidance for corrugated tubes parallel to the e-chain®

- Additional, simple guidance for corrugated tubes on the outside of the e-chain®
- PMA CLIP support to be easily clipped on corrugated tubes with nominal widths 07, 10, 12 17 mm
- Easy access to the corrugated tubes, fast replacement of the hoses
- Reduce assembly time and cost - easy to assemble, without any additional screws or tools
- The part number includes the e-chain® with TUB side sections; the PMA CLIP support and the hose are ordered separately

Part No. TUB	Part No. TUB	Part No. TUB	For corrugated tube nominal diameter
Outer link right*	Outer link left*	Outer link at both ends*	\emptyset [mm]
E4.38L.XXXTUBR.R.0	E4.38L.XXXTUBL.R.0	E4.38L.XXXTUB.R.0	07 / 10 / 12 / 17

*As viewed from the fixed end

Complete Part No. with the width index XXX of Bi and the minimum bend radius (R). Example:

E4.38L.100TUBR.150.0 = with TUB outer sections every 2nd right hand link

Product range | PMA CLIP | Support, one-piece, with safety clip

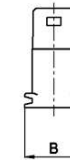
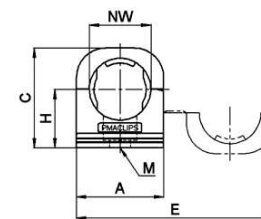

PMA CLIP support - one-piece construction with safety clip, suitable for corrugated tubes

Part No.	NW	A	B	C	H	E	M
PMA CLIP	\emptyset [mm]	mm	mm	mm	mm	mm	mm
I-BFH-07-0	07	17.0	20.0	21.5	13.5	40.5	M4
I-BFH-10-0	10	20.5	20.0	24.5	15.5	47.5	M5
I-BFH-12-0	12	24.0	20.0	27.0	16.5	54.5	M5
I-BFH-17-0	17	30.0	20.0	34.0	20.0	68.0	M6