

Single-Entry Power Connection with Junction Box

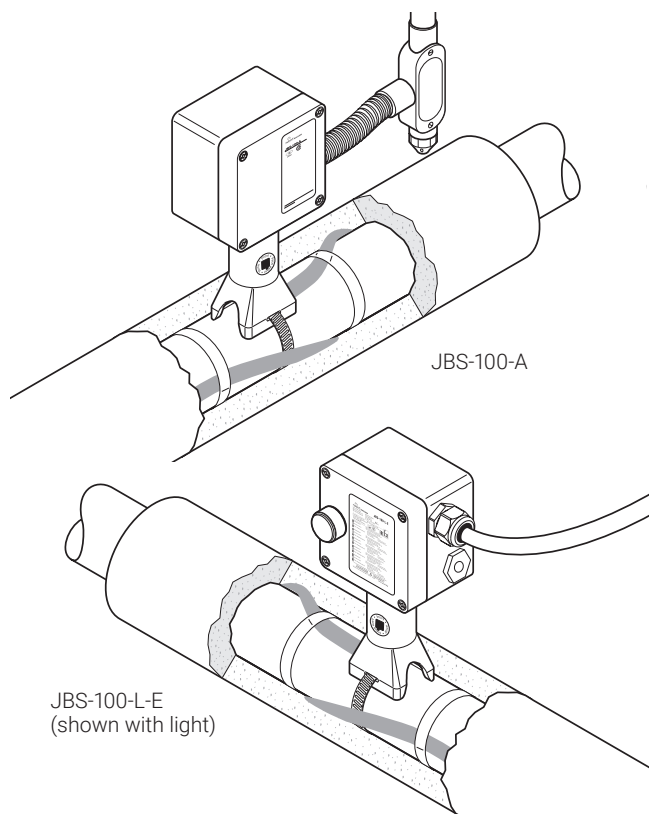

The nVent RAYCHEM JBS-100 kit is designed to connect power to a single nVent RAYCHEM BTV, QTVR, XTV, KTV, HTV or VPL industrial parallel heating cable. It is approved by FM, CSA, and PTB for use in hazardous locations.

The JBS-100 integrates the functions of both connection kits and insulation entries. The rugged stand protects the heating cable and allows for up to 100 mm (4") of thermal insulation.

The core sealing boot does not require a heat gun or torch for the installation (no hot work permit necessary). The non-curing sealant (silicone free) in the boot allows easy installation and facilitates maintenance.

Spring-type terminals provide fast installation and safe, reliable, maintenance-free operation. This connection kit significantly reduces installation time. The kit is offered in three basic versions, customised for local installation practices. All kits are also available as a lighted version. These include a unique light module with a superbright LED that simply plugs into the terminals, and a lens in the lid. This provides indication that power is available in the box. There is also a connection kit with drain plug available.

DESCRIPTION











JBS-100-A JBS-100-L-A	JBS-100-E JBS-100-L-E JBS-100-D-E	JBS-100-EP JBS-100-L-EP
This connection system is certified for use in North America and has one through-hole for use with 3/4" conduit.	This connection system is certified for use in IEC regions and provides two M25 threaded entries, one stopping plug, and one plastic power cable gland.	This connection system is certified for use in IEC regions and provides two M25 threaded entries, an earthing plate, and an external earthing stud. It is designed for use with armoured cables.

KIT CONTENTS

<ul style="list-style-type: none"> 1 junction box with terminals 1 light module (for -L only) 1 stand 1 core sealer 1 green/yellow earthing sleeve 1 polywater sachet 1 cable tie 	<ul style="list-style-type: none"> 1 junction box with terminals 1 light module (for -L only) 1 stand 1 core sealer 1 green/yellow earthing sleeve 1 M25 gland for power cable with 8-15 mm diameter 1 M25 stopping plug 1 polywater sachet 1 cable tie 1 ATEX/IECEx Certified drainplug (for JBS-100-D-E only) 	<ul style="list-style-type: none"> 1 junction box with terminals, earth plate, and stud 1 light module (for -L only) 1 stand 1 core sealer 1 green/yellow earthing sleeve 1 M25 stopping plug 1 polywater sachet 1 cable tie
--	---	--

APPROVALS (**)

Hazardous locations

JBS-100-A JBS-100-L-A	JBS-100-E JBS-100-L-E JBS-100-D-E	JBS-100-EP JBS-100-L-EP
	PTB 20 ATEX 1008 U  II 2 G Ex eb mb IIC Gb  II 2 D Ex tb mb IIIC Db IECEX PTB 20.0014U Ex eb mb IIC Gb Ex tb mb IIIC Db	
	 TC RU C-BE.МЮ62.В.00054/18 Ex e IIC Gb U Ex tb IIIC Db U Ex e mb IIC Gb U Ex tb mb IIIC Db U Ta -55°C...+56°C IP66 Ta -55°C...+40°C IP66 (-L versions only) ООО "ТехИмпорт" (4) (3) TC RU C-BE.ИМ43.В.01712	
	DNV-GL Approval for use on ships and mobile offshore units. When used with BTV, QTVR Heating systems: DNV certificate number TAE00000TU When used with XTV, KTV Heating systems: DNV certificate number TAE00000TV	
	 (2) BR-EX e II BR-Ex em II	
 (1)(2) Zone 1, AEx eb IIC T* Gb Zone 21, AEx tb IIIC T*°C Db	 (2) Ex eb IIC T* Gb Ex tb IIIC T*°C Db	
Zone 1, AEx eb mb IIC T* Gb Zone 21, AEx tb IIIC T*°C Db (for -L only)	Ex eb mb IIC T* Gb Ex tb mb IIIC T*°C Db (for -L only)	
 (2) Ex eb IIC T* Gb Ex tb IIIC T*°C Db		
Ex eb mb IIC T* Gb Ex tb mb IIIC T*°C Db (for -L only)		
 (1)(2) Class I, Div. 2, Groups A, B, C, D Class II, Div. 1 & 2,  (2) Groups E, F, G Class III Type 4X Temp Code T*		
 Class I, Div. 2, (Zone 2 (5)) Groups A, B, C, D Class I Zone 2 GROUP IIC Zone 2 (HTV heating cable only)		
	 (3) Non lighted versions: Ex e IIC Gb Ex tD A21 IP66 Lighted versions: Ex e mb IIC Gb Ex tD mbD 21 IP66	

* For system T-rating, see heating cable or design documentation.

(1) Except VPL.

(2) Excluding HTV heating cable.

(3) Approval pending for HTV heating cable.

(4) Localized versions may exist with limited approvals and different part numbers. Contact your local sales representative.

(5) Per C22.1 Table 18

DIMENSIONS (NOMINAL)

	JBS-100-A JBS-100-L-A	JBS-100-E JBS-100-L-E JBS-100-D-E	JBS-100-EP JBS-100-L-EP

PRODUCT SPECIFICATIONS

	JBS-100-A JBS-100-L-A	JBS-100-E JBS-100-L-E JBS-100-D-E	JBS-100-EP JBS-100-L-EP
Heating cable capability	BTV-CR, BTV-CT, QTVR-CT, XTV-CT, KTV-CT, HTV-CT, VPL-CT		
Ingress protection	IP66	IP66	IP66
Entries	1 x 3/4"	2 x M25	2 x M25
Ambient temperature range	-55°C to 56°C (JBS-100-A) -40°C to 40°C (JBS-100-L-A)	-55°C to +56°C* (JBS-100-E and JBS-100-D-E) -40°C to +40°C (JBS-100-L-E)	-55°C to +56°C* (JBS-100-EP) -40°C to +40°C (JBS-100-L-EP)
	*Extra conditions for safe use apply at ambient temperatures >40°C. Temperature resistant power cable and metal glands must be used. Please refer to the certificate or installation instructions for full details.		
Min. installation temperature	-55°C	-55°C	-55°C
Max. pipe temperature	Refer to heating cable specification		
Terminals	Spring-type terminals 2 line, 1 ground	Spring-type terminals 1 phase, 1 neutral, 1 earth	Spring-type terminals 1 phase, 1 neutral, 1 earth
Max. conductor size	8 AWG stranded	10 mm ² stranded, 10 mm ² solid	10 mm ² stranded, 10 mm ² solid
Max. operating voltage	277 Vac	480 Vac*	480 Vac*
	*JBS-100-L-E and JBS-100-L-EP are limited to 254 Vac. Extra conditions for safe use apply for voltages higher than 254 Vac. Please refer to the certificate or installation instructions for full details.		
Max. continuous operating current (***)	53 A	53 A	53 A

(***) For pipe temperature >150°C and <260°C and XTV, KTV or HTV heating cables, the maximum operating current shall be reduced to maximum 20 A.

MATERIALS OF CONSTRUCTION

Enclosure, lid, and stand	electrostatic charge-resistant glass-filled engineered polymer, black	electrostatic charge-resistant glass-filled engineered polymer, black	electrostatic charge-resistant glass-filled engineered polymer, black
Lid screws	Stainless steel	Stainless steel	Stainless steel
Lid gasket	Silicone rubber	Silicone rubber	Silicone rubber
Earth continuity plate	N/A	N/A	Steel, zinc plated, and blue chromated

OPTIONAL LED INDICATOR LIGHT

	JBS-100-A JBS-100-L-A	JBS-100-E JBS-100-L-E JBS-100-D-E	JBS-100-EP JBS-100-L-EP
Colour	Red	Green	Green
Voltage rating	100-277 Vac	100-254 Vac	100-254 Vac
Power consumption	< 1 W	< 1 W	< 1 W

Ordering details (**)

POWER CONNECTION

Part Description (**)	JBS-100-A	JBS-100-E	JBS-100-EP
PN (Weight)	085947-000 (2.5 lb)	829939-000 (1.2 kg)	158251-000 (1.3 kg)

POWER CONNECTION WITH LIGHT

Part Description	JBS-100-L-A	JBS-100-L-E	JBS-100-L-EP
PN (Weight)	944699-000 (3.5 lb)	054363-000 (1.6 kg)	075249-000 (1.7 kg)

POWER CONNECTION WITH DRAIN PLUG

Part Description		JBS-100-D-E	
PN (Weight)		1244-021057 (1.4 kg)	

ACCESSORIES

Conduit drain 3/4"	JB-DRAIN-PLUG-3/4IN (prevents condensate from collecting in the box) ONLY FOR JBS-100-L-A
Small pipe adaptor	JBS-SPA, required for pipes ≤ 1" (DN 25) E90515-000 (bag of 5 adaptors)
Junction box stand off	JBS-100 STANDOFF, P000003408 For insulation 120 ≥ 180 mm
Glands for power cables	GL-55-M25 hazardous area approved gland for cables 8-15 mm (temperature range -55°C/70°C) GL-36-M25 hazardous area approved gland for cables 8-17.5 mm (temperature range -20°C/70°C)

(**) Localized versions may exist with limited approvals and different part numbers. Contact your local sales representative.