

ENGINEERING  
YOUR SPRAY SOLUTION



# ➤➤ AIR QUALITY CONTROL SYSTEMS

in the steel industry

AIR QUALITY CONTROL SYSTEMS





# ENVIRONMENTAL SOLUTIONS FOR THE STEEL INDUSTRY FROM THE GLOBAL LEADER FOR NOZZLE TECHNOLOGY

For over 140 years, we have pioneered numerous groundbreaking developments in the field of nozzle technology. For this, we combine our comprehensive know-how in the field of nozzle engineering with an in-depth understanding of process and plant requirements. This means that we can provide solutions for the important challenges of the steel industry, such as:

- Emission reduction (NO<sub>x</sub>, SO<sub>x</sub>, fine dust)
- Cost reduction through energy-optimized processes
- Adapted plant technology with customized solutions

## Cool solutions for a hot market

Significant changes have been ongoing in the steel industry for many years now. First, there is tremendous consolidation in the sector. Second, strict emission requirements are creating a constant pressure to invest and innovate. Efficient gas conditioning offers a wide range of approaches to reducing costs and increasing efficiency.

A prerequisite is that the respective processes are thoroughly understood and that gas cleaning conditioning is adapted accordingly.

## The right solution for every requirement

Our wide range of nozzle and gas conditioning systems provides a good basis for every application.

**We work together with you to develop the optimum solution for your specific case. We support you with comprehensive consulting services ranging from process analysis to turnkey solutions.**

## Industry competence across the entire steel process

The steel, aluminum and non-ferrous industry is facing major challenges. Metallurgical materials are coming under increasing pressure from non-metallic alternatives. In addition, the metallurgical requirements for steel materials used in the plants, automotive and building construction industries have been increasing for many years. This is accompanied by pressure of cost and ever stricter emission requirements.

Continuous process optimization is essential in existing installations. Simple exchange of wearing parts is a poor solution due to the high downtime costs. An understanding of the processes and process environment and optimization measures are key in this context. Lechler products also play an important part in direct reduction with hydrogen and contribute to avoiding CO<sub>2</sub> emissions as part of climate-neutral steelmaking.



# COMPETENCE – THE ADVANTAGE OF MULTIPLE PERSPECTIVES



## Much more than just nozzles

At Lechler we know a lot about the steel industry thanks to our extensive practical experience. But it doesn't stop there. We are also able to replicate spray processes in computer-aided simulations. This allows us to optimize the processes by taking into account different variables. We test the individual nozzles and system solutions in our own test laboratory.

## Worldwide presence

To provide you with local support, we are represented all around the globe – with locations in the USA, Great Britain, India, China, ASEAN, France, Belgium, Italy, Finland, Hungary, Spain and Sweden, as well as sales partners in almost every country.

Thanks to our decades of experience in many different industrial sectors, we consider your challenges by viewing the overall process rather than just the individual steps. We will gladly advise you on this.

## CONTENTS

<b>Steelmaking</b>	
<b>An overview</b>	<b>4</b>
<b>Lechler applications</b>	<b>6–9</b>
<b>Choosing the right nozzle</b>	<b>10</b>
Spillback nozzles	12
VarioJet nozzles	14
Laval nozzles	16
Nozzle lances	18
VarioCool and Vario Clean Gas Cooling and Gas Conditioning systems	20–23
Lechler Online Cleaning (LOC)	24
<b>Gas conditioning</b>	<b>26</b>
Nozzles for gas scrubbing and gas cleaning	28
TwinAbsorb	29
<b>Standard nozzles</b>	<b>30</b>
<b>Droplet separator systems</b>	<b>32</b>
Droplet separators for vertical gas flow	33
Droplet separators for horizontal gas flow	34
<b>CFD analysis</b>	<b>36</b>
<b>Measuring technology</b>	<b>38</b>
<b>Engineering and Service</b>	<b>39</b>

# STEELMAKING AN OVERVIEW

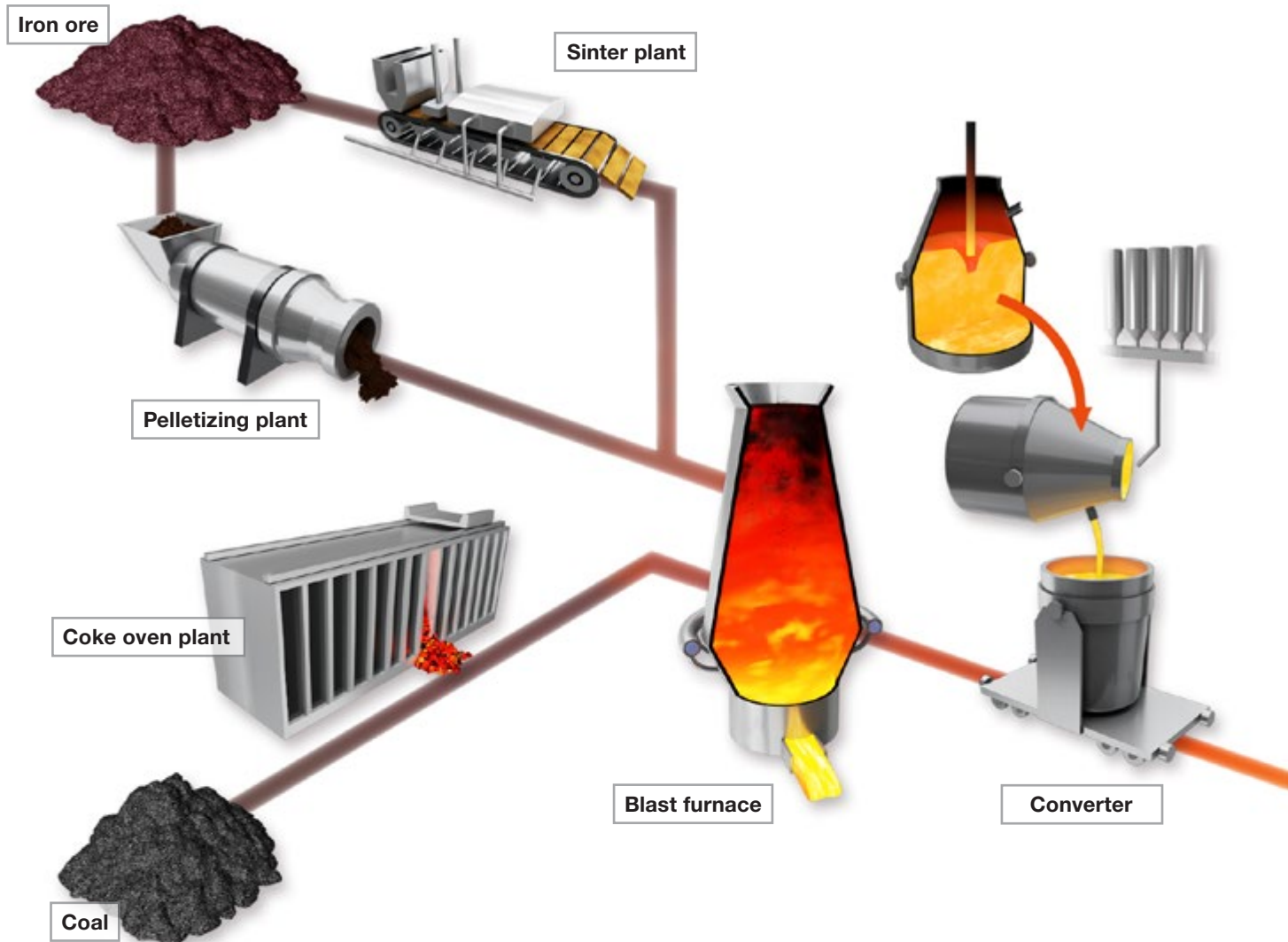

## Use

Lechler nozzles have been an established part of the steelmaking process for many years. They can be found in the raw material supply process for coke oven and sinter plants in the blast furnace route, for example. They are also used in the petrochemical industry and hydrogen technology for direct reduction processes in the electric steel route. Lechler nozzles and droplet separators make a crucial contribution to ensuring the desired quality and efficient production in all process steps – from refining in the converter and alloying in secondary metallurgy through to cooling in continuous casting and then in the rolling mills.

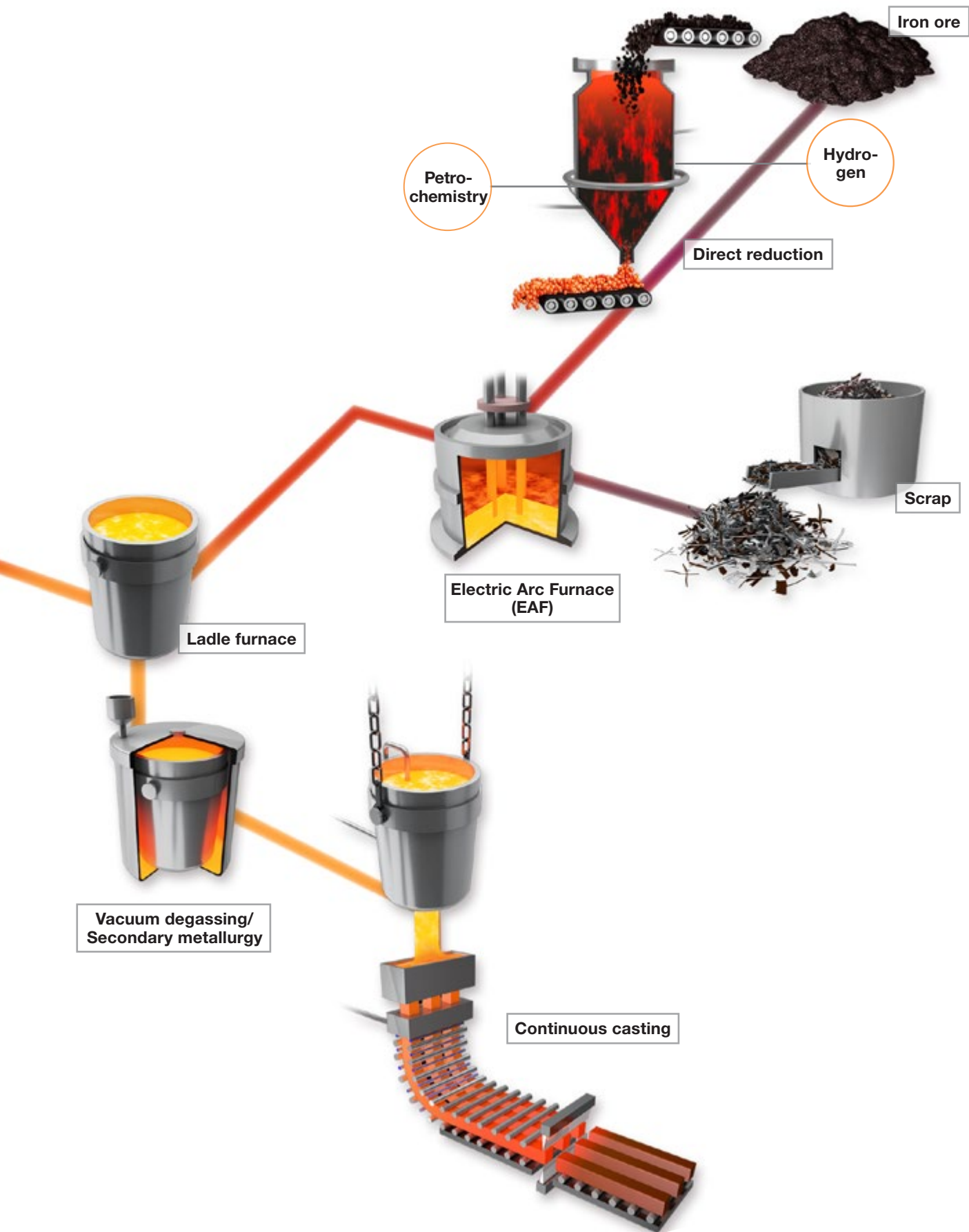

# LECHLER APPLICATIONS IN STEELMAKING

BLAST FURNACE ROUTE

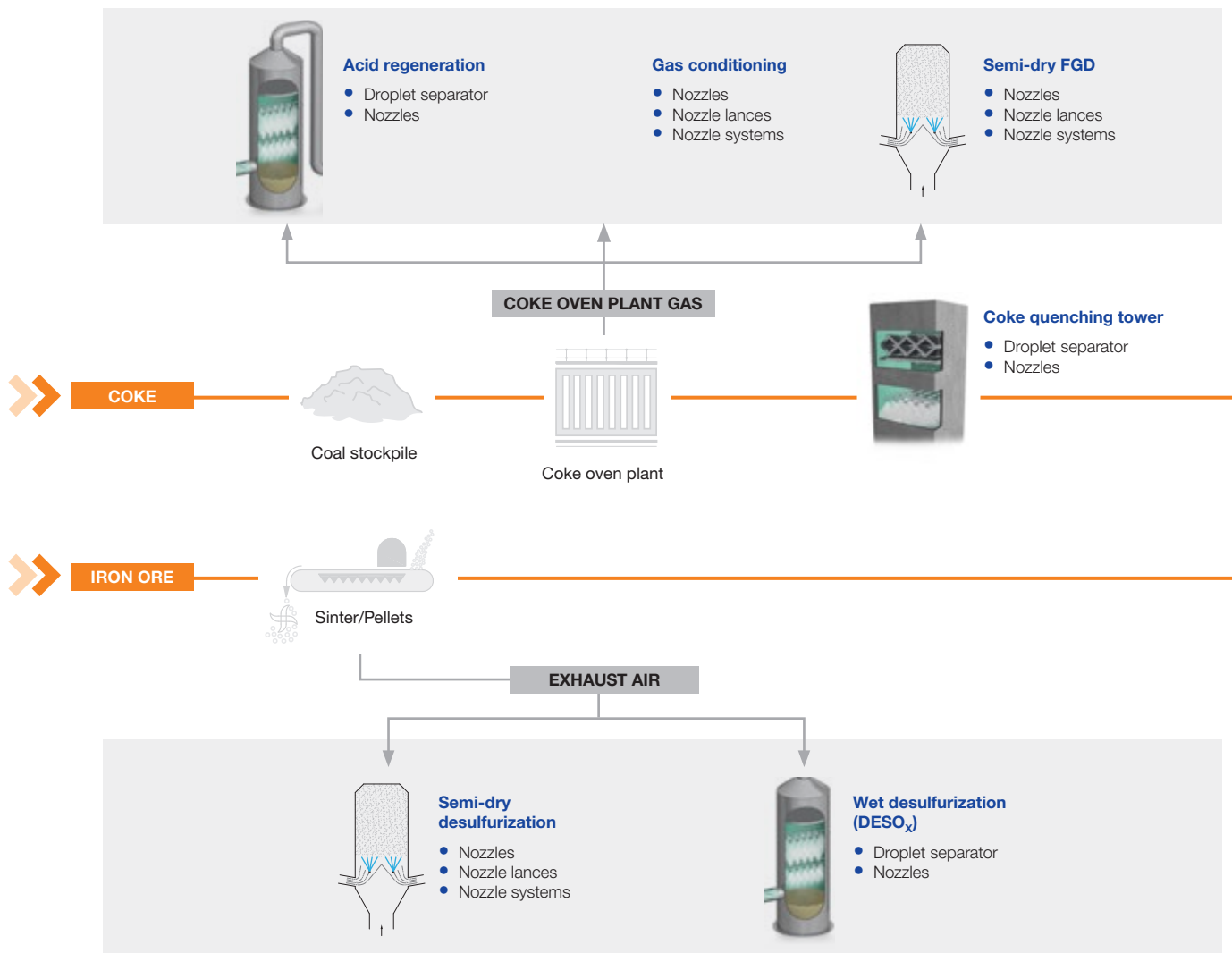

DRI ROUTE

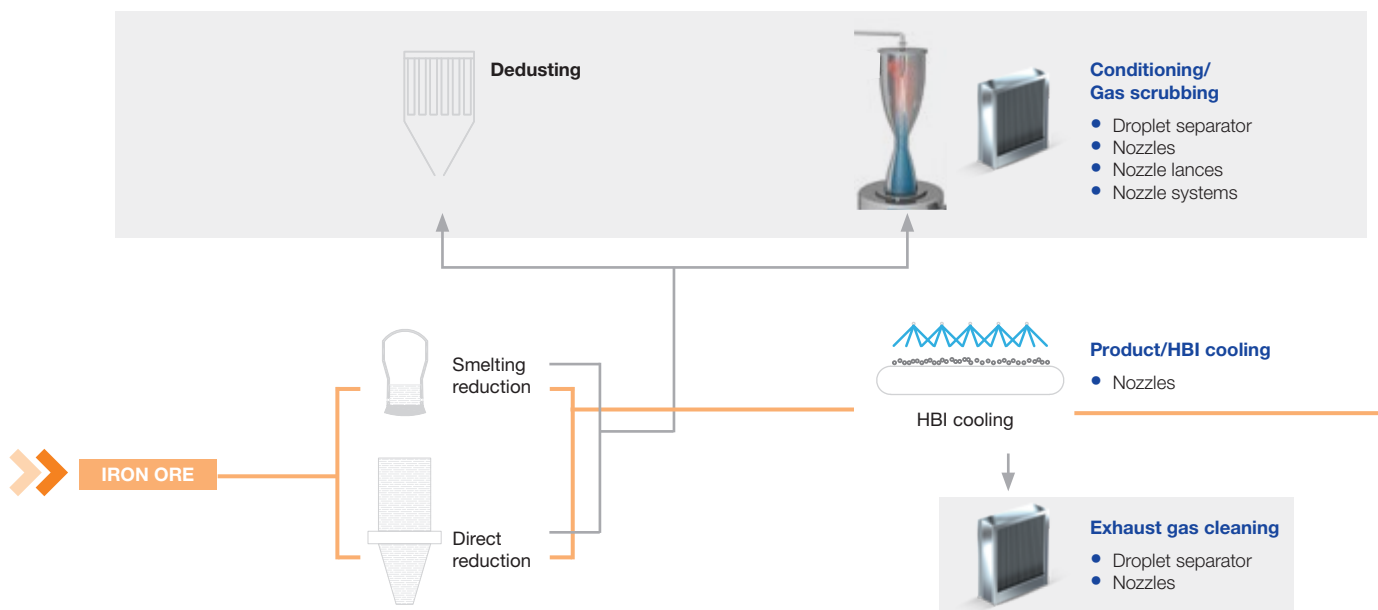

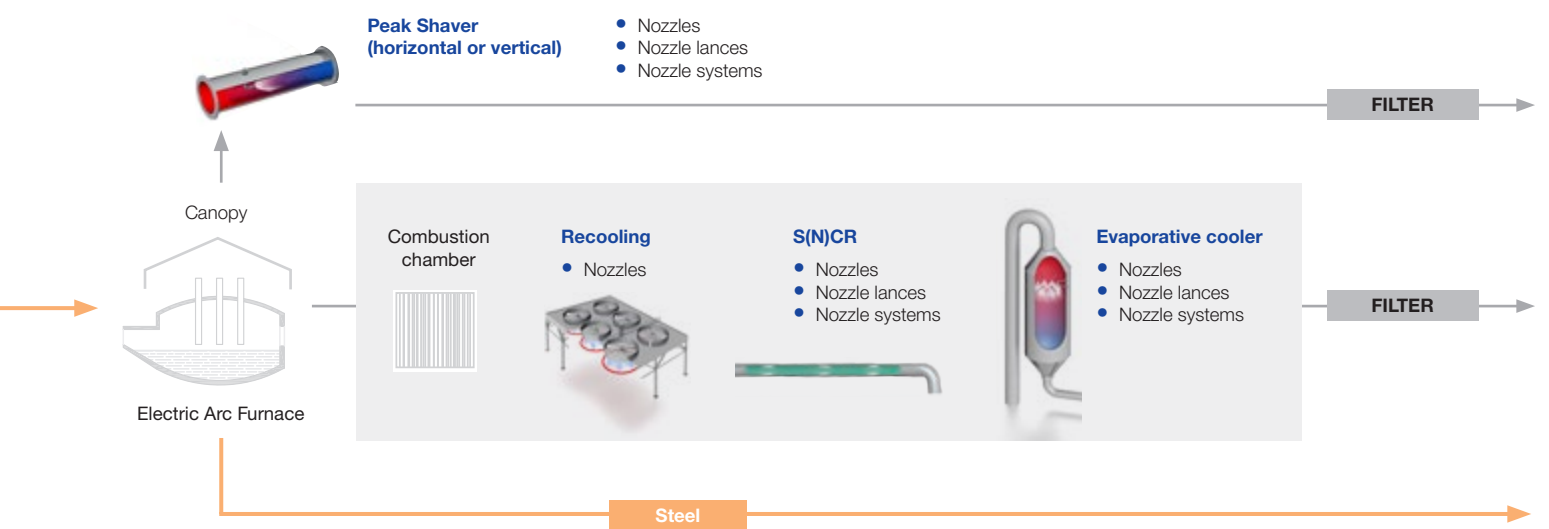
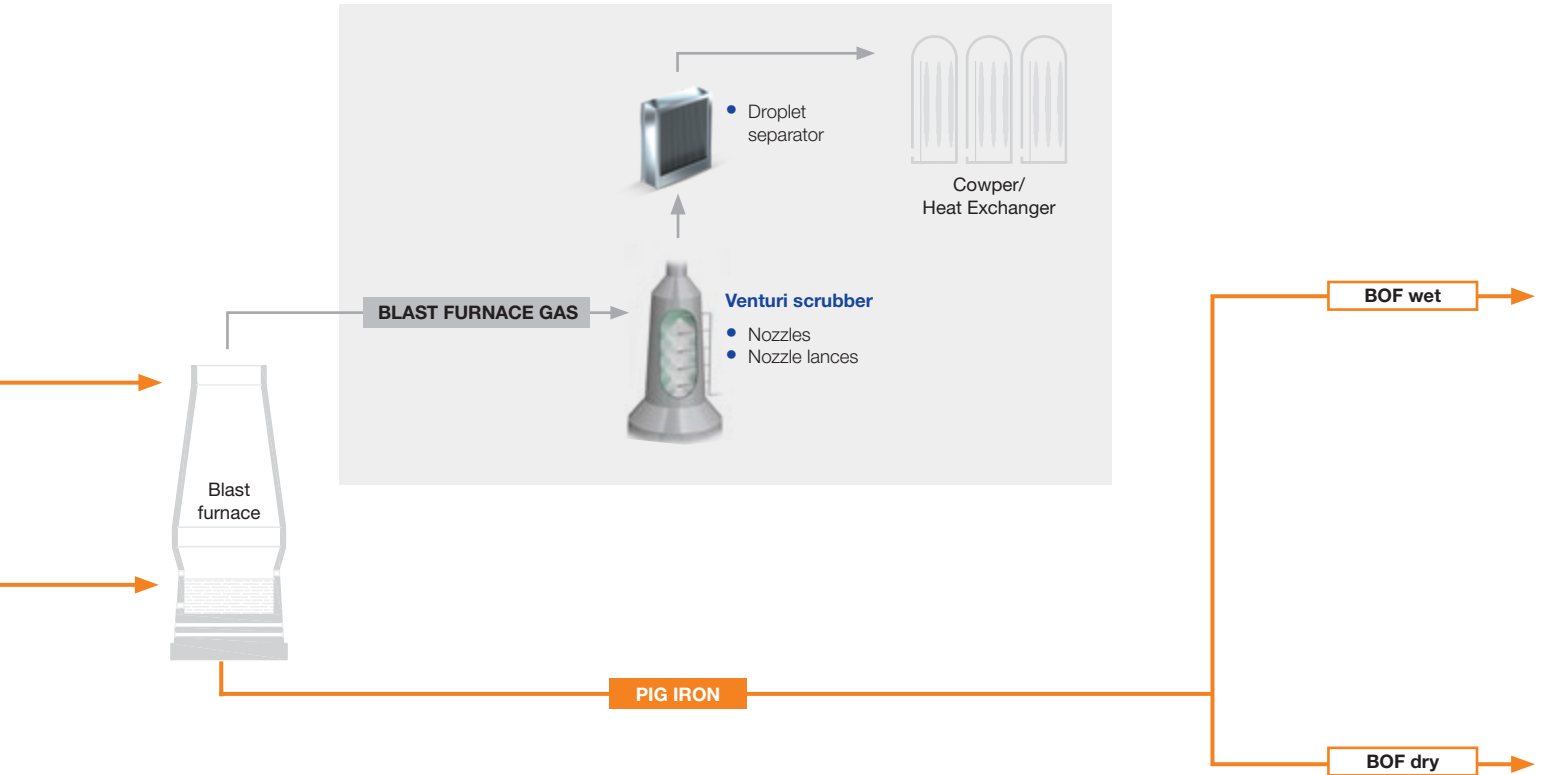



BLAST FURNACE ROUTE

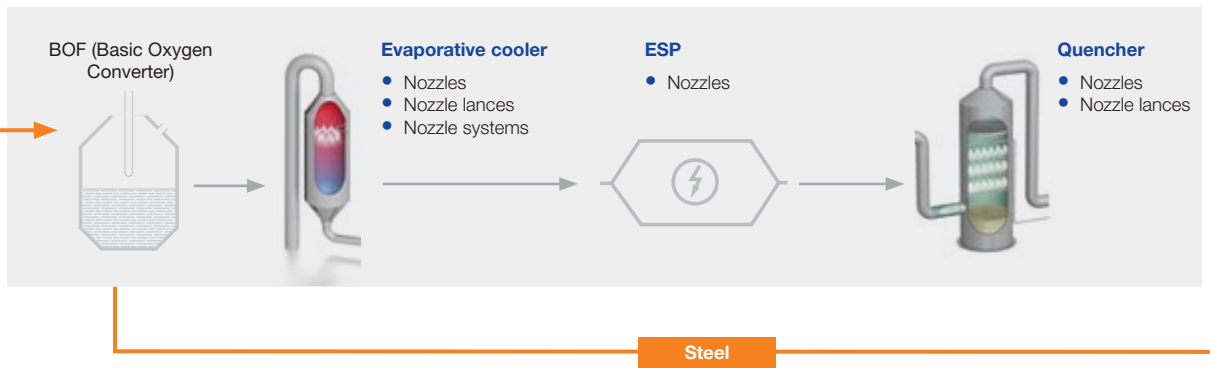
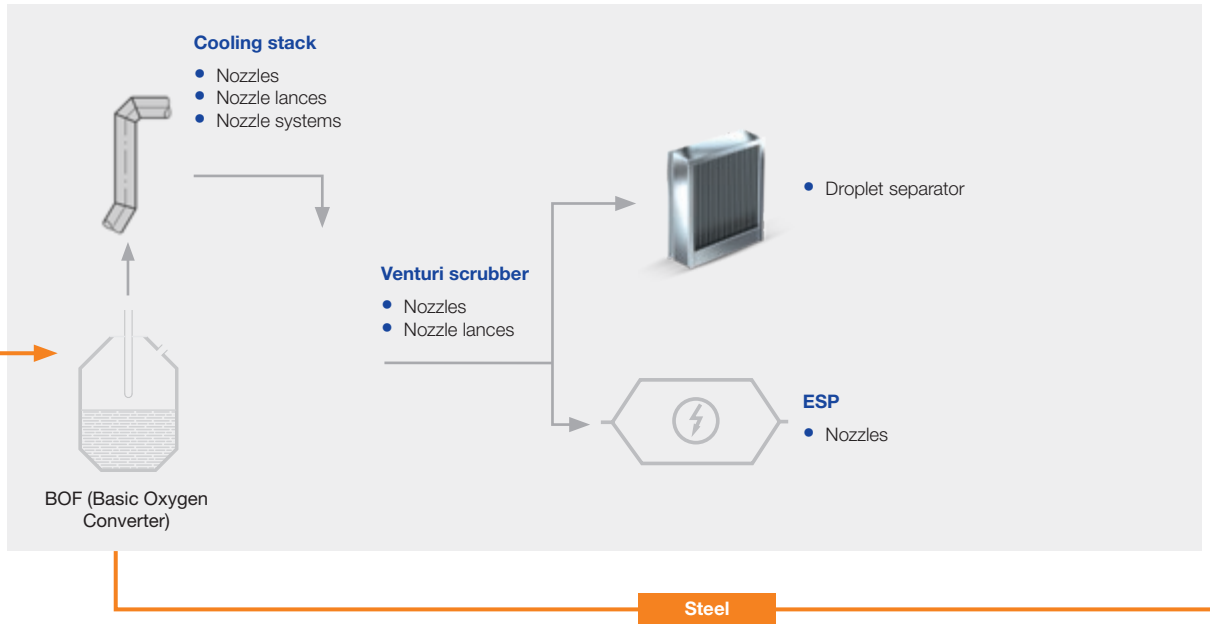

DRI ROUTE

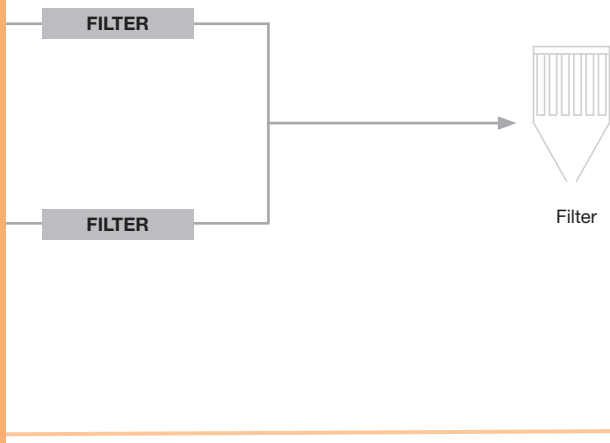





Nozzles



Nozzle lances



Nozzle systems



Droplet separator



**Peak Shaver  
(horizontal or vertical)**

- Nozzles
- Nozzle lances
- Nozzle systems



Hood

Ladle treatment

**Steam jet pump**

- Nozzles



Vacuum treatment

Steel

# ➤➤ CHOOSING THE RIGHT NOZZLE

Best results are achieved in gas cooling and conditioning processes only when detailed knowledge of process-specific requirements is available to assist in the choice of nozzles.

**We will provide you with comprehensive advice taking your system and the applications you require into account.**





# ➤ Spillback nozzles

## Atomization without compressed air

**Lechler spillback nozzles** atomize liquids as a fine hollow cone according to the pressure atomization principle. The water is sent to the nozzle with a relatively constant feed pressure, independent of the flow rate.

The amount of liquid injected is adjusted via a control valve in the spillback line. The maximum atomized flow rate is achieved with the control valve closed.

Uniform and fine liquid atomization is achieved across the entire control range.

The atomized flow rate can be distributed over cluster heads with up to six small nozzles.

The number of lances can be significantly reduced thanks to the total spray angle of about 120°.



### Properties:

 **Spray angle of the individual nozzles**  
90° or 60° as hollow cone

 **High turn-down ratio**  
up to 12 : 1

 **Even and fine liquid atomization**  
over the entire control rang

 **Execution**  
as single or cluster nozzle lances possible

 **Low operating costs**  
as no atomizing air required

 **Typical pressure range**  
of 35 bar, g in the supply line at the nozzle

### Use

Gas cooling in medium-sized and large gas cooling towers.



## Spillback nozzle

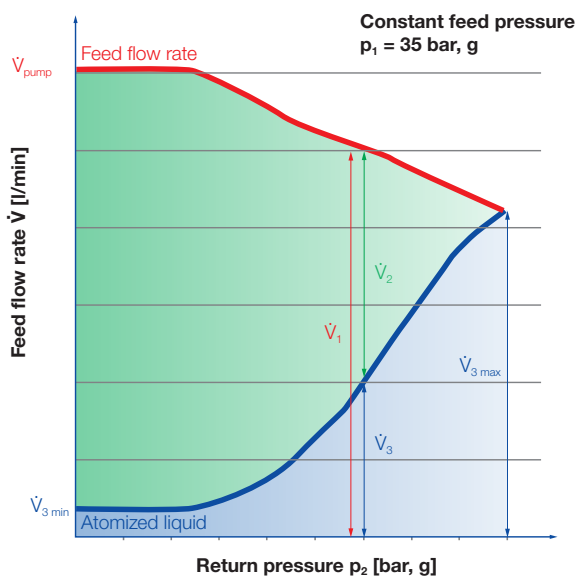
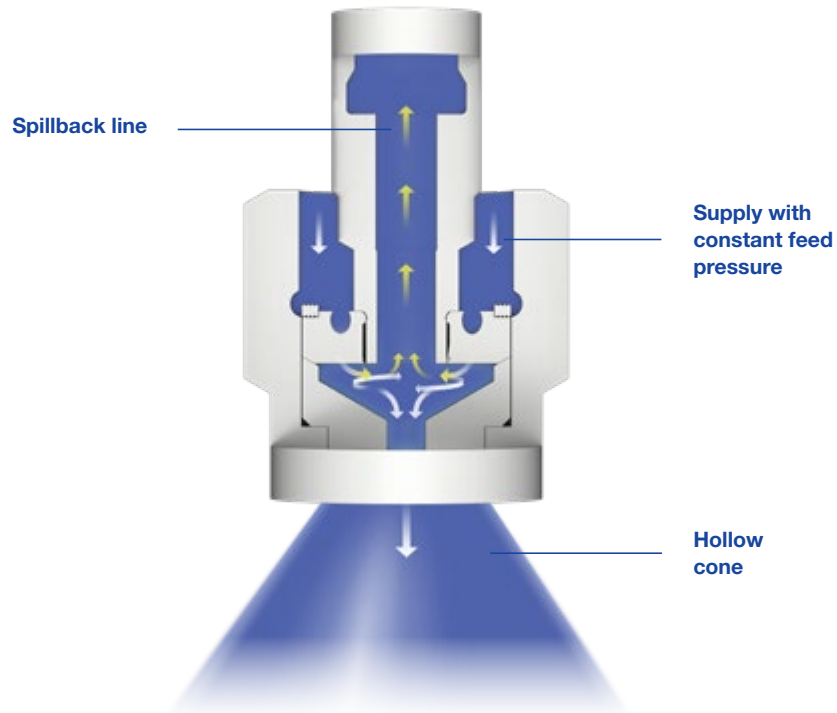

- $\dot{V}_1$ : feed flow rate
- $\dot{V}_{\text{pump}}$ : max. feed flow rate
- $\dot{V}_2$ : return flow rate
- $\dot{V}_3$ : atomized liquid rate
- $\dot{V}_3 = \dot{V}_1 - \dot{V}_2$
- $\dot{V}_{3 \text{ min}}$ : min. atomized liquid (return line open)
- $\dot{V}_{3 \text{ max}}$ : max. atomized liquid (return line closed)
- $p_1$ : constant feed pressure
- $p_2$ : return pressure
- Turn-down ratio:  $\dot{V}_{3 \text{ max}} / \dot{V}_{3 \text{ min}}$



Spray pattern of a single spillback nozzle

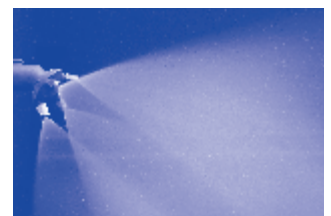

Spray pattern of a cluster spillback nozzle lance



## VarioJet nozzles

# Twin-fluid nozzles with low air consumption despite large outlet angle

With this twin-fluid nozzle, the water is fed in axially via a bore hole.

This thin liquid film is split into finest droplets by the atomizing air in the mixing chamber. The resulting two-phase mixture is then atomized a second time when exiting via several bore holes arranged in a circular fashion.

The spray is characterized by a large outlet angle with an even liquid distribution and a low air consumption. The fineness of the droplet spectrum is decisively influenced by the air/liquid ratio and by the pressure level of the two flow rates. As a general rule: the higher the air/liquid ratio and the higher the pressure level of atomizing air and liquid is, the finer the droplet spectrum.

The large free cross-sections in the nozzle keep the risk of clogging and the maintenance effort to a minimum.



### Properties:



#### Large spray angle

(60°, 90°) for good coverage of the cross-section of the duct



#### High turn-down ratio

up to 20 : 1



#### Adjustment of the droplet spectrum

by changing the air/fluid ratio



#### Clog-resistant

thanks to large free cross-sections without internal fittings



#### Low air consumption



#### Typical pressure range

Liquid 1–9 bar, g  
Atomizing air 1–6 bar, g

### Use

Gas cooling in medium-sized and large evaporative coolers.

## Twin Fluid Nozzle

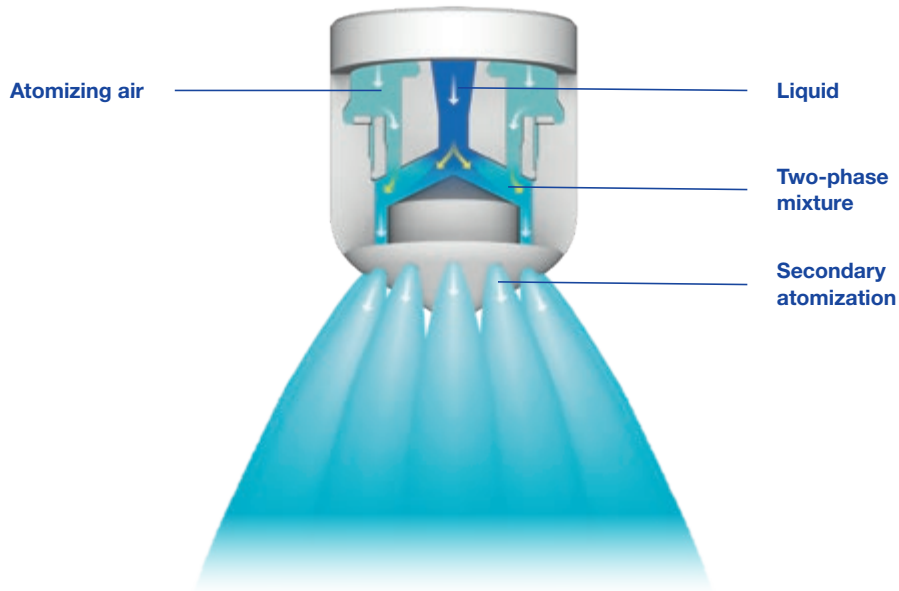

## Variable control concepts of twin-fluid nozzles

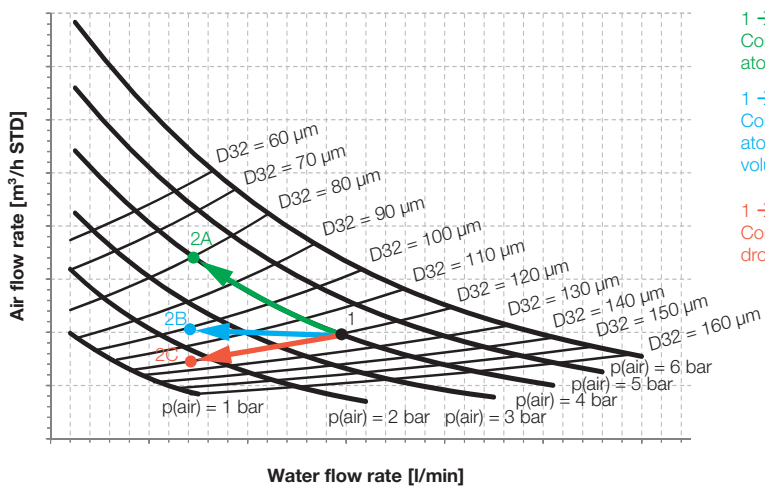

Spray pattern of the VarioJet nozzle



# Laval nozzles

## Twin-fluid nozzles for a wide droplet spectrum in special applications

**Lechler Laval nozzles** atomize liquids as a fine full cone.

A dual-phase mixture is created from atomizing air and liquid in the mixing chamber inside the nozzle. The shape of the nozzle causes this mixture to be accelerated to supersonic speed, resulting in an extremely fine atomization of the droplets.

By changing the air/liquid ratio, the droplet size and the droplet spectrum can be adapted within a wide range. The large free cross-sections of the nozzle also allow atomization of viscous or solids-laden liquids.

Choosing the right material prevents wear even where abrasive media are present, and enables use at high temperatures.



### Properties:



#### Small spray angle

(15°), suitable for small cross-sections and horizontal ducts



#### Very large turn-down ratio

of 20 : 1 (in some cases up to 40 : 1)



#### Adjustment of the droplet spectrum

by changing the air/fluid ratio



#### Clog-resistant

thanks to large free cross-sections without internal fittings



#### Very fine droplet spectrum



#### Typical pressure range

Liquid 1–6 bar, g  
Atomizing air 1–6 bar, g

### Use

- Gas cooling in gas-bearing pipes (ducts) and medium-sized and small gas cooling towers
- Injection of solids-laden water
- Introduction of lime water in the desulfurization process
- Injection of aqueous ammonia or urea solution for the DeNOx process (SNCR/SCR)
- Chemical process engineering (spray dryers etc.)
- Spray dry evaporation of waste water



## Laval nozzle

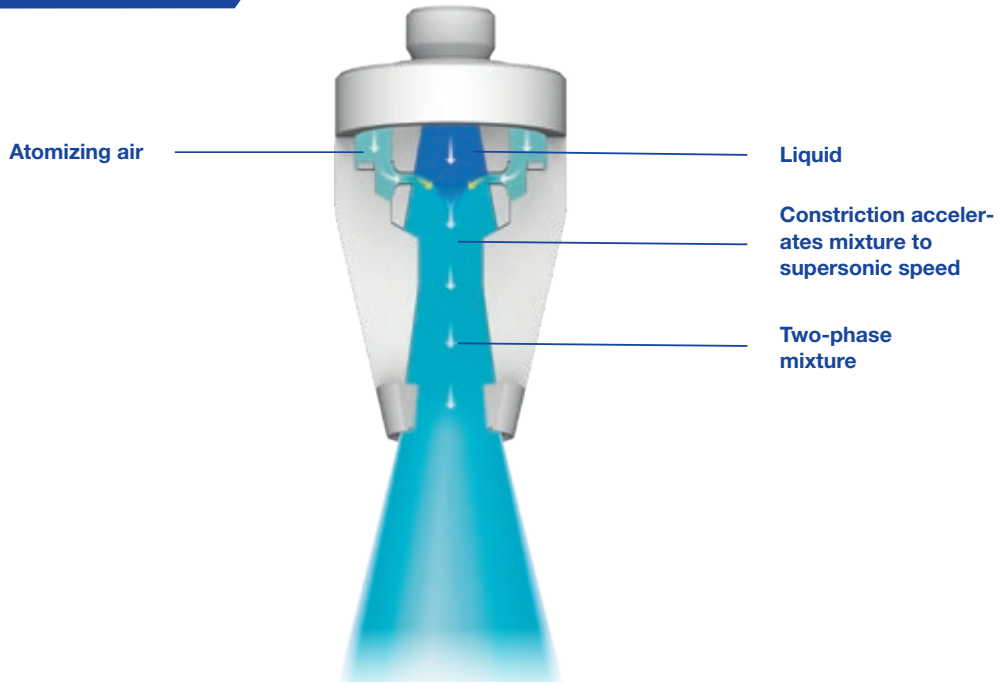

## Operating point of a twin-fluid nozzle

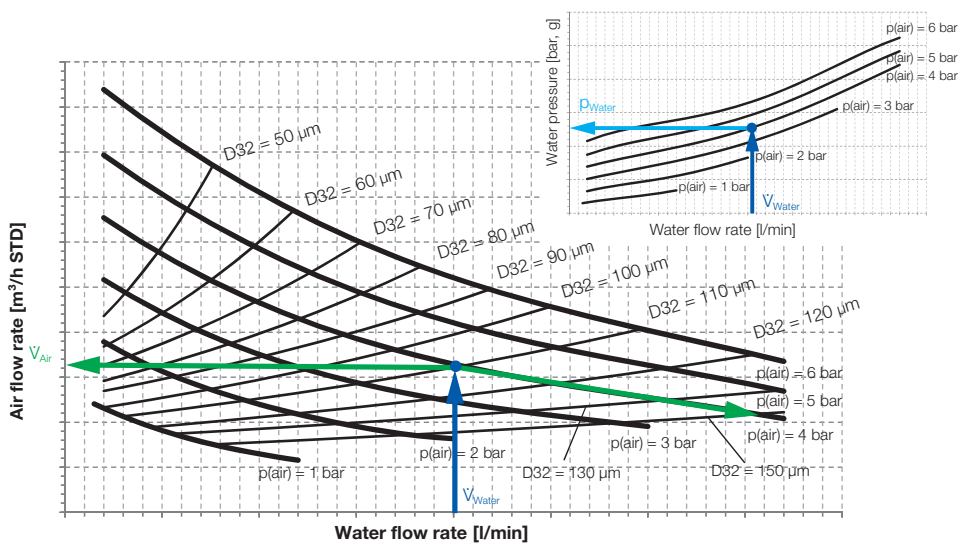

Spray pattern of the Laval nozzle

# ➤ Nozzle lances

## Highest spraying accuracy in the flue gas duct

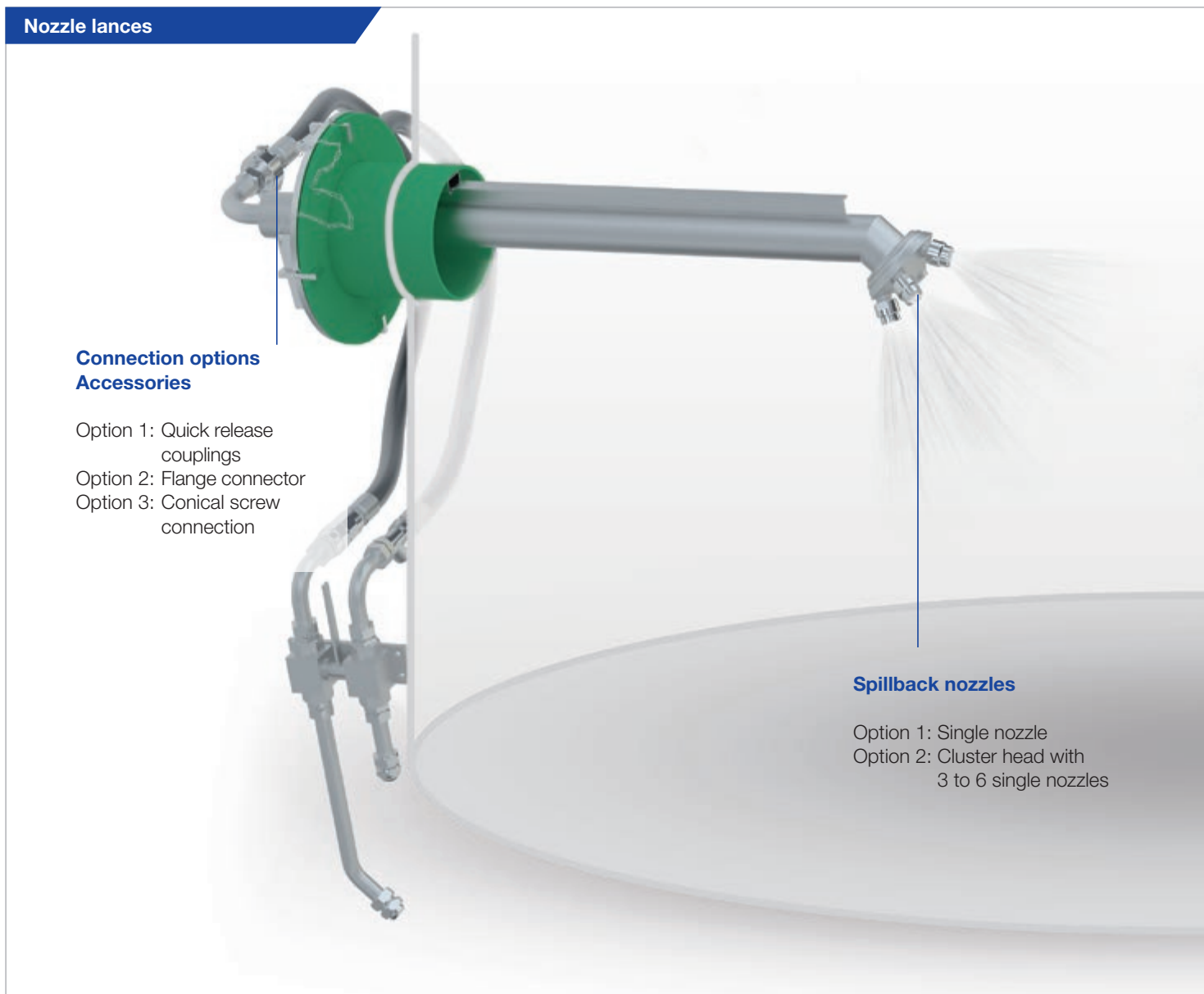

**Lechler nozzle lances** ensure optimal spray placement and alignment in flue gas ducts. The nozzles themselves have a low-maintenance design and can be quickly cleaned or exchanged with minimal effort.

### The following lance options are available

- Protection tube to increase the service life in case of higher temperatures, high dust loads and aggressive gases, with barrier air as an option
- Wedge flange, standard flange and special flange in accordance with customer requirements
- Guide rail to facilitate lance installation
- Shifting device to change the insertion length – with or without gastight sealing
- Expansion joint or stuffing box for expansion compensation at high temperatures
- Assembly connecting piece with flange connector for welding onto flue gas duct
- Special customizations such as wear protection, insulation, water cooling or coating also up to temperatures of 2,100 °C possible
- Pre-assembled accessory kits for process media connections (e.g. quick release couplings, shut-off ball valves, strainers)

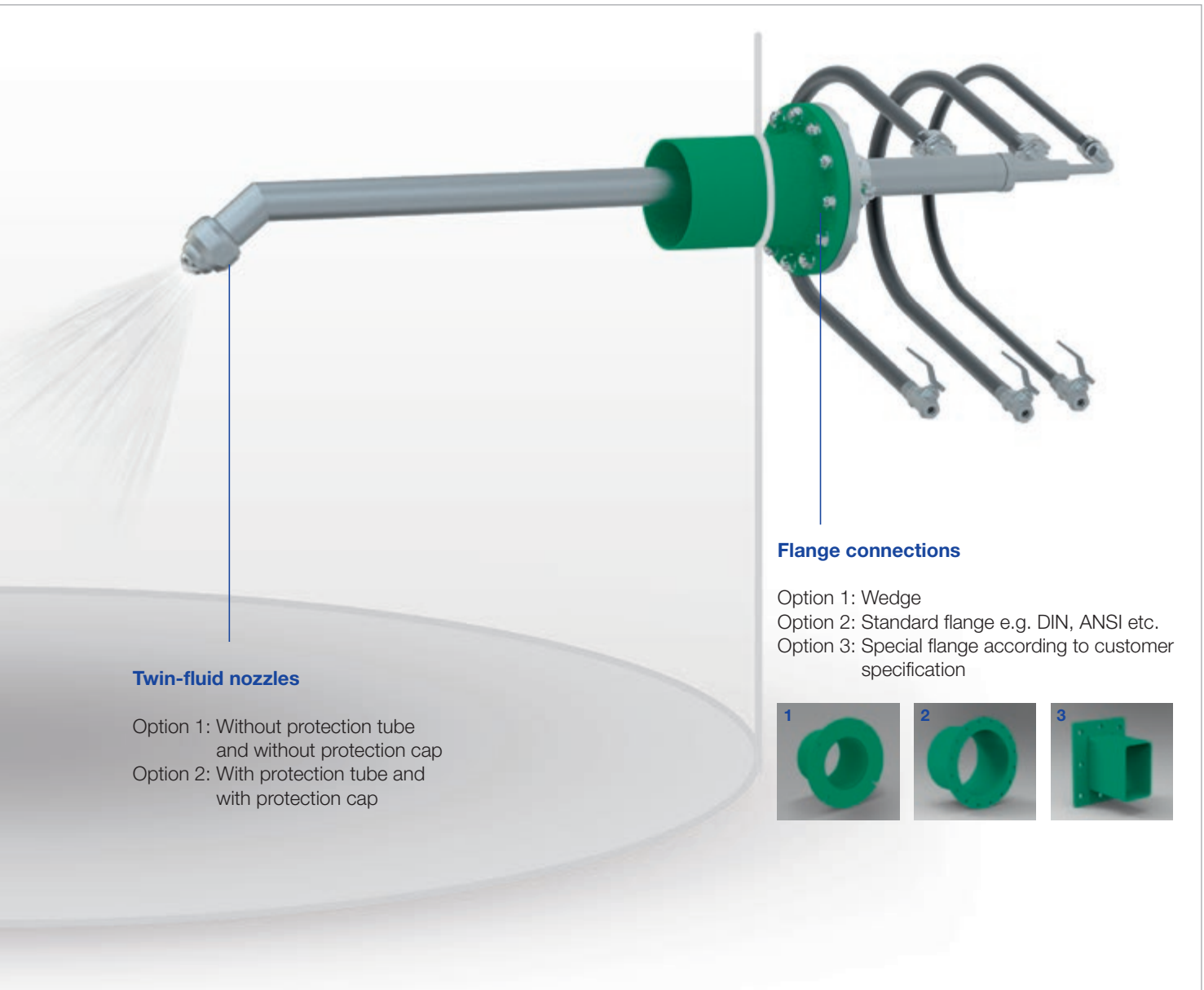

**Twin-fluid nozzles**

- Option 1: Without protection tube and without protection cap
- Option 2: With protection tube and with protection cap

**Flange connections**

- Option 1: Wedge
- Option 2: Standard flange e.g. DIN, ANSI etc.
- Option 3: Special flange according to customer specification

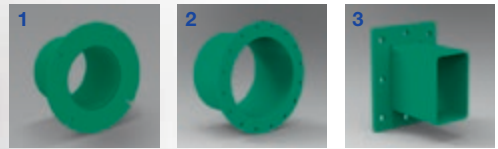

**Material**

Lances are manufactured from stainless steel (316/316L) as standard, but depending on requirements can also be made of chemical and high-temperature resistant materials. Accessories are available in galvanized steel or stainless steel and the hoses are available in rubber or stainless steel.

**Talk to us**

Each gas cooling tower and flue gas duct is different. Which is why standard solutions do not always make sense. Speak with us and let us work together to find the best solution for your purposes.

# ➤ VarioCool and VarioClean Gas Cooling/ Conditioning Systems

## For a perfectly tailored solution

Our valve skid units for regulating the flow rates of water and atomizing air are individual customer-specific solutions. Based on the requirements in each case, our first step is to design an overall concept and select the best components in order to create a perfectly tailored solution.

### First-class engineering

To perform our engineering, we determine all relevant parameters and define the plant's design:

**Nominal diameters, pressure stages, pump and control valve design, P&I diagram, equipment and signal lists** (optional).

Of course, the project is fully documented to ensure that technology and processes can be quickly traced even after years of use.

### High-quality components

The economic efficiency of a solution is determined to a large extent by the service life of the products used. Unexpected failures can quickly lead to plant stoppages and costly production outages.

Which is why we fit our valve skid units with high-quality components from well-known manufacturers as standard and the most important functional components are even realized in redundant design.

The components are interconnected with pipes and mounted on a stable base frame with eyelets for crane transportation.

### Tested quality

The design (e.g. dimensioning of nominal diameters) and production are in line with the latest state of the art and comply with all relevant standards. They are equally subject to the Lechler quality management system certified to DIN EN ISO 9001, as is the final acceptance. Before delivery, the valve skid unit undergoes a pressure and tightness test.

### Control concept from the nozzle specialist

Numerous installations of *VarioCool* and *VarioClean* systems, years of commissioning experience, plus expertise in nozzle technology all contribute to the constant improvement and optimization of Lechler control systems. The flexible and fully automatic concept can be perfectly adapted to your process. You will have start-up and shut-down scenarios and dynamic process conditions under perfect control with our solution.



## ➤ Option packages for our *VarioCool* and *VarioClean* valve skid units

### Electrical wiring of the components

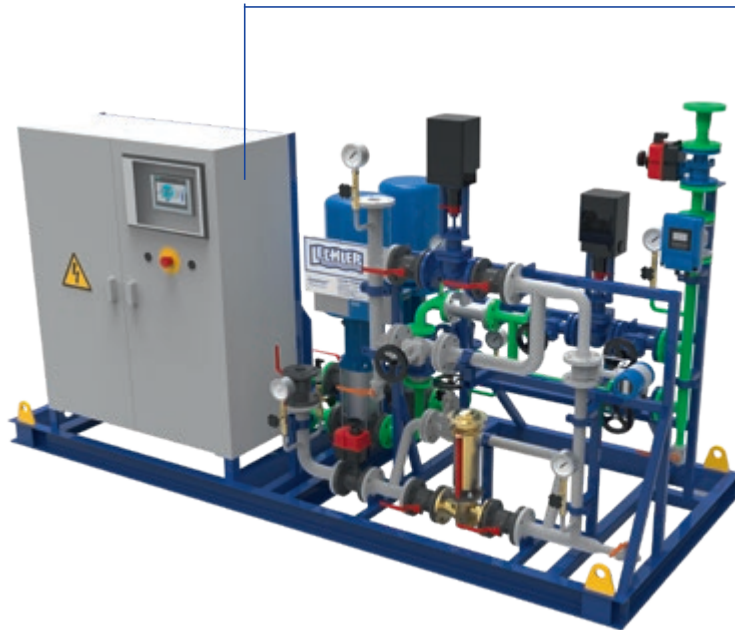

#### Control cabinet with complete PLC

All components including the pumps are wired to a control cabinet.

The complete injection control allows all relevant process parameters to be visualized over a control panel on the control cabinet.

Specific configuration and extensive testing make commissioning much faster. Communication and the exchange of signals (set-point, plant status, error messages) with the customer's logic system is carried out via PROFIBUS or PROFINET.

The control has several modes of operation such as automatic mode and manual mode for tests during plant downtimes.

In the event of faults, the installed modem allows quick remote diagnosis and minimizes possible downtimes.



#### Junction box

All components except the pump motors are wired to a junction box within the valve skid unit.

This assures that the customer has a central connection point for all electrical components and measuring devices for further processing in the higher-level control.

# ➤ VarioCool and VarioClean Gas Cooling/ Conditioning Systems For a perfectly tailored solution

## Extended scope of delivery

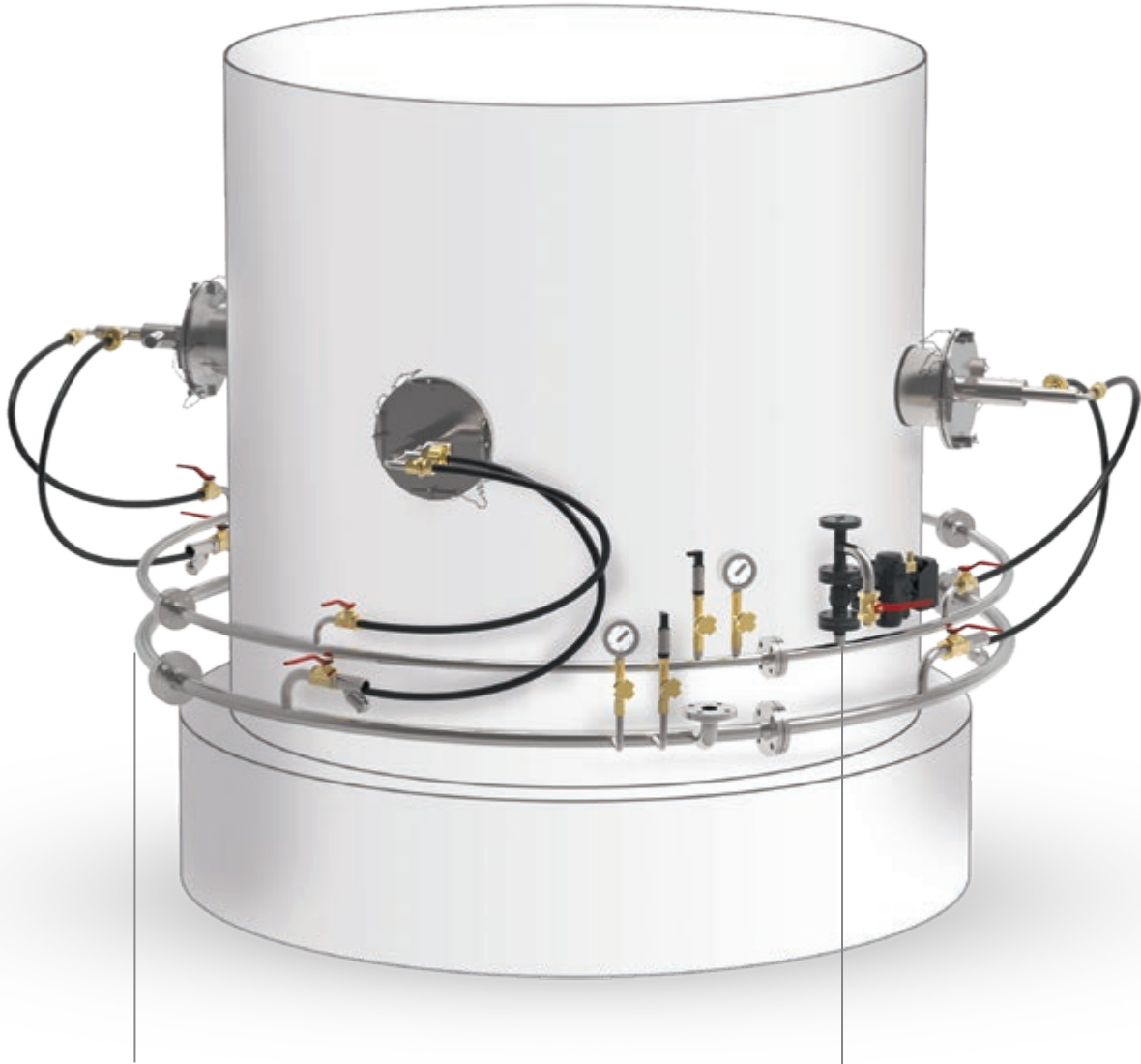

### Ring mains

Lechler supplies ring mains and headers together with the corresponding brackets for welding onto the flue gas duct. Accessories such as pressure transmitters and manometers plus the appropriate connections for the lances and supply lines are also included in the scope of delivery.

### Purge air connection

In order to increase the injection turn-down ratio, individual lances or lance groups can be connected or disconnected. If the disconnected lances are in the flue gas duct, the rest of the fluid should be purged. Vaporization and deposits in the lance can be prevented in this way.

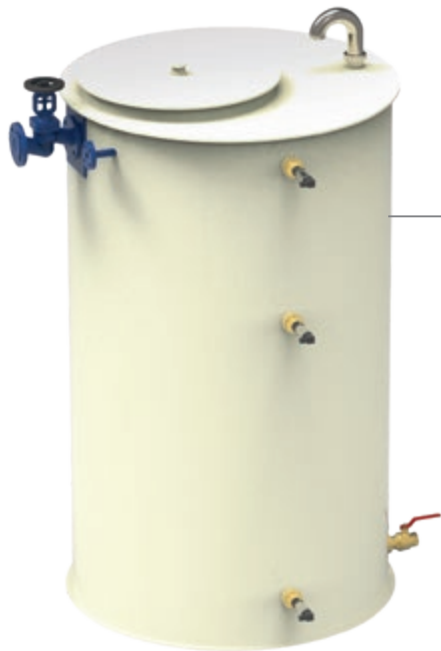

#### Water tank

A water tank made of steel or plastic serves as a reservoir for the valve skid unit and guarantees injection operation in the event of the water supply failing. Its size is adapted to the injection quantity. The components for tank filling and level monitoring are included in the scope of delivery.



#### Barrier air fan

In order to protect the nozzles and lances from dust deposits and/or high temperatures, barrier air is frequently applied to them. For this purpose, Lechler supplies fans geared to the specific application with various optional attachments such as a throttle valve, suction filter and silencer.



#### Temperature measurement

For a constantly regulated outlet temperature, it is very important for the response characteristics of the temperature sensors to be adapted to the ambient conditions. Lechler provides the appropriate thermometers and assists you in defining the installation position.

#### Talk to us

Do you require an option that is not listed? Or are you having planning issues? No problem. Tell us what your requirements are. We will find the appropriate solution and ensure a seamless integration.

# Lechler Online Cleaning (LOC) Cleaning-in-Place system for twin-fluid nozzle lances

In the semi-dry flue gas cleaning processes used in power plants, an alkaline suspension, usually lime slurry, is injected into the hot flue gas in spray towers. The droplets injected by twin-fluid nozzles are evaporated by the transferred heat. At the same time, pollutants such as SO<sub>2</sub>, HCl and HF react with the reactants in the washing fluid.

The suspension frequently causes damaging deposits and blockages in the nozzles, nozzle lances and pipelines. In the past, reliable long-term plant installation was often not possible without regularly dismantling and cleaning the nozzle lances. Good process results frequently came at the cost of high maintenance effort.

**The Lechler LOC Cleaning-in-Place system eliminates the need for complex disassembly, unnecessary downtimes and personnel costs and permits reliable continuous operation thanks to use of hard-metal nozzles.**

## Injection of wastewater



Spray absorbers/dryers



Ring mains with LOC unit

## LOC makes your plant more economically efficient

Lechler offers an online cleaning system tailored to the respective application which allows reliable continuous operation and inexpensive cleaning of the nozzle lances. The nozzles are made of wear-resistant hard metal and have been optimized for atomizing suspensions. The individual lances are cleaned

cyclically during ongoing operation using precisely metered quantities of cleaning agents. In many cases, minimum use of diluted citric acid (10%) and compressed air is sufficient for reliable cleaning while at the same time ensuring compliance with the process limit values.

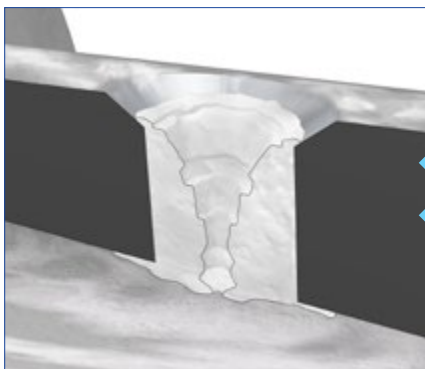

Blocked air holes

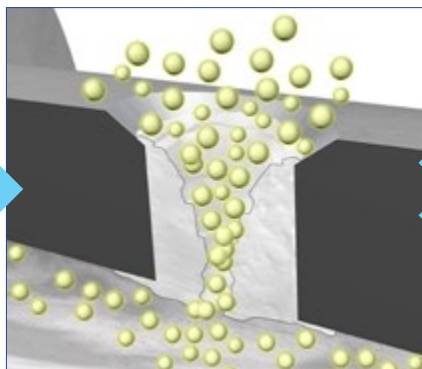

Cyclical cleaning with citric acid doped in compressed air

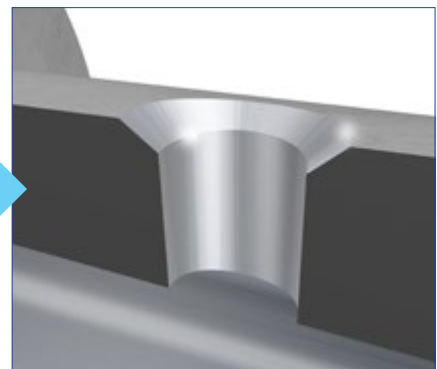

Cleaned nozzle



LOC reference installation  
with maximum equipment  
configuration

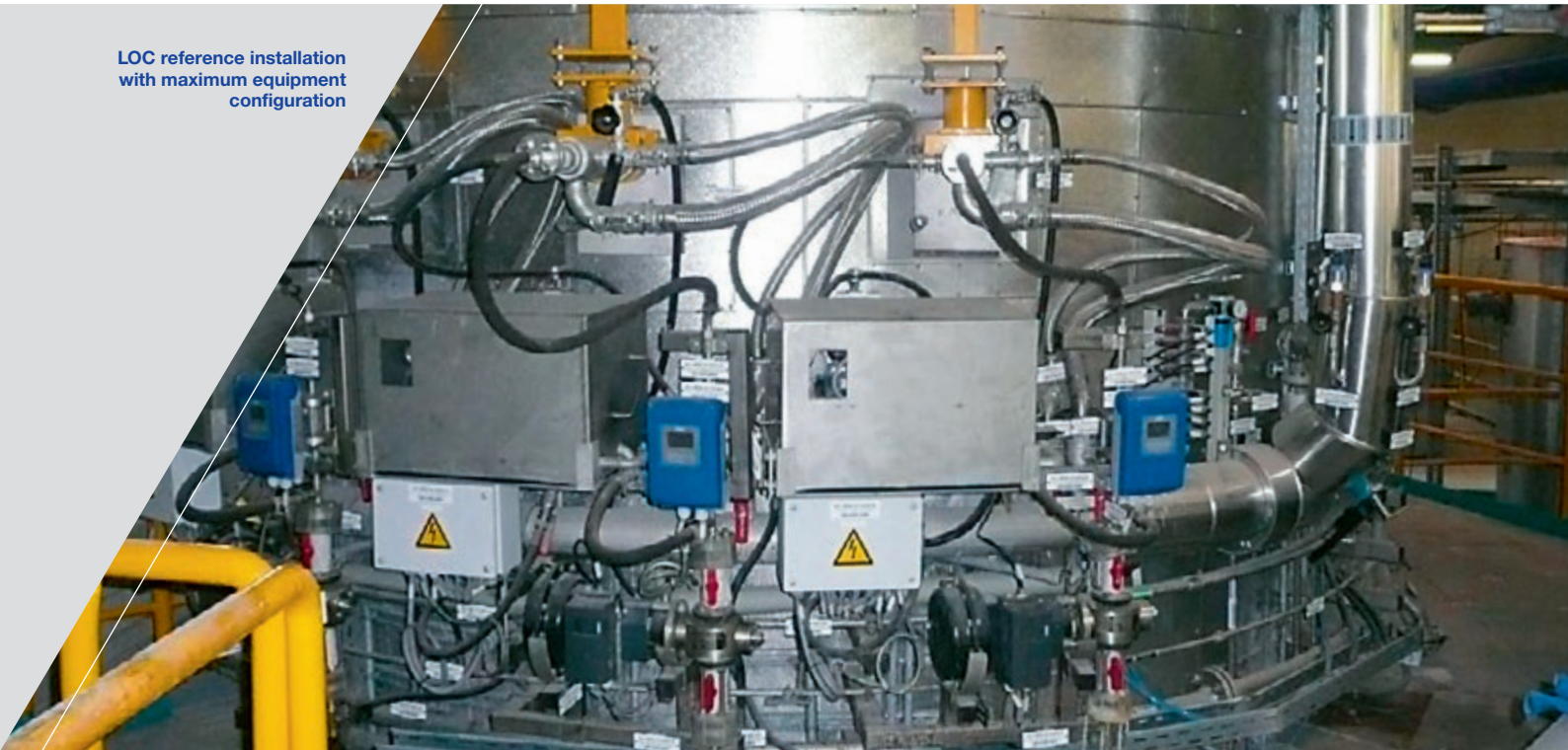

A visible difference: nozzles before and after LOC treatment

#### Advantages

- High availability of the spray reactor/dryer
- Uninterrupted operation
- Minimum maintenance effort
- Low costs through the controlled use of cleaning agents

#### Talk to us

Lechler Online Cleaning (LOC) is a tailor-made solution. The better we know your requirements and operating conditions, the more efficiently your processes will run. Let's talk to each other – about efficiency, cost savings and success.

# GAS CONDITIONING DENITRIFICATION (DENOX)

Depending on various process variables, emissions of harmful nitrogen oxides (NOx) are produced in metallurgical processes.

In **DeNOx applications**, twin-fluid nozzles are used as a general rule, whereby the reagent (typically aqueous ammonia or urea solution) is atomized with compressed air. The advantage that twin-fluid nozzles have compared to single-fluid nozzles lies in the controllability of the droplet size and in the realization of a large flow-rate control range. Due to the varying

local conditions (duct size, gas velocity, temperature etc.) and the different response characteristics of the injected media, it must be possible to control the droplet size and thus the depth of penetration.

In DeNOx applications with SNCR processes, small Laval nozzles are usually used. For SCR processes and special SNCR applications there are special nozzles available.

## Injection of aqueous ammonia

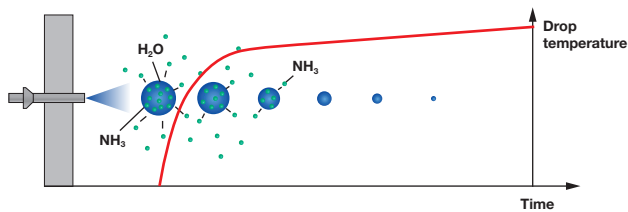

When injecting aqueous ammonia, the evaporation process of ammonia and water starts immediately after leaving the nozzle.

## Injection of urea solution

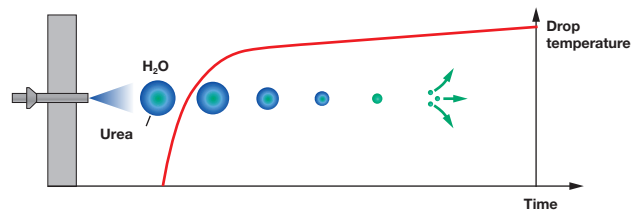

In the case of urea solution, the water must evaporate completely first before the urea can split into its components and the  $\text{NH}_3$  can react with the NOx.

## SNCR process

For the non-catalytic reaction, a reagent (mostly aqueous ammonia) is specifically injected in the area of the optimum temperature window of approx. 950–1,050 °C. The efficiency will be reduced if the temperature exceeds or falls below the temperature window. Alongside the optimum temperature, parameters such as droplet size and velocity are also of crucial importance. Only with the appropriate nozzle, matching control concept and a suitable position can the droplets penetrate deep enough into the flue gas flow to ensure optimum distribution of the reducing agent in the flue gas flow.

## SCR process

In the SCR process, the reducing agent is injected before the catalyst. It must be distributed as homogeneously as possible in the flue gas flow and evaporate before reaching the catalyst. This makes extremely short evaporation distances possible at a low temperature level of approx. 300-400 °C.

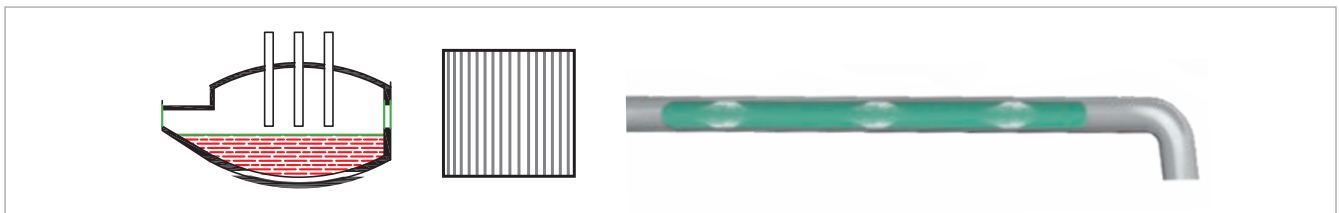

## Our solution

Lechler has developed twin-fluid nozzles with extremely fine droplet spectra and exact controllability in order to guarantee complete evaporation over this short distance. Depending on the customer's process design, Lechler supplies the suitable nozzle lances and also the injection system where applicable.



## Pneumatic atomizing nozzles

### Series 150

**Twin-fluid nozzles** of the 150 series generate a particularly uniform full-cone jet with a spray angle of up to 30°. The nozzles feature external mixing, i.e. the gas and liquid are mixed outside the nozzle body. External mixing is particularly suitable for atomizing viscous media or media that have a tendency to crystallize.

The nozzle has optimum emergency operation characteristics in the event of failure of the atomizing gas and can also be operated with low liquid pressures. Steam can also be used as the atomizing medium. However, it is necessary to take into account the specific boundary conditions in this case. Please ask us for further information.

The droplet size is determined mainly by the gas-water ratio. The higher the gas share, the smaller the droplets.

Twin-fluid nozzles of the 150 series are available in all steel grades, chromium-nickel alloys and plastics (PVC, PVDF, PTFE).



The 150 series is available in the material stainless steel with various connections.

### Properties:



**Spray angle**  
20°–30°



**Steam pressure**  
7.0–50.0 bar g



**Gas pressure**  
1.0–10.0 bar g



**Flow rate (water with steam)**  
0.65–140.9 l/min



**Flow rate (water with gas)**  
0.15–140.9 l/min



**Turn-down ratio**  
1 : 5

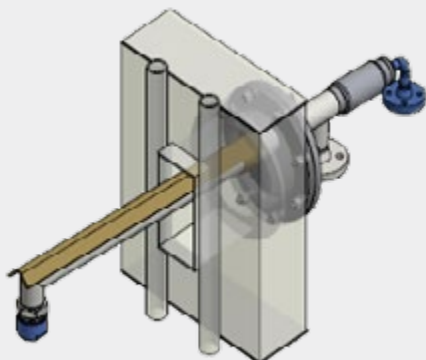

# ➤ Nozzles for gas scrubbing and gas cleaning

**Nozzles used for gas scrubbing or cleaning in scrubbers must function precisely in the long term and at the same time withstand extremely aggressive ambient conditions. Lechler has developed atomizing nozzles made of hard metal and ceramic materials for this purpose.**

Alongside the classic nozzles, Lechler TwinAbsorb nozzles perform efficient flue gas cooling and cleaning. Their improved efficiency, reduced operating costs as well as low maintenance costs make TwinAbsorb nozzles the first choice for both process and economic reasons.

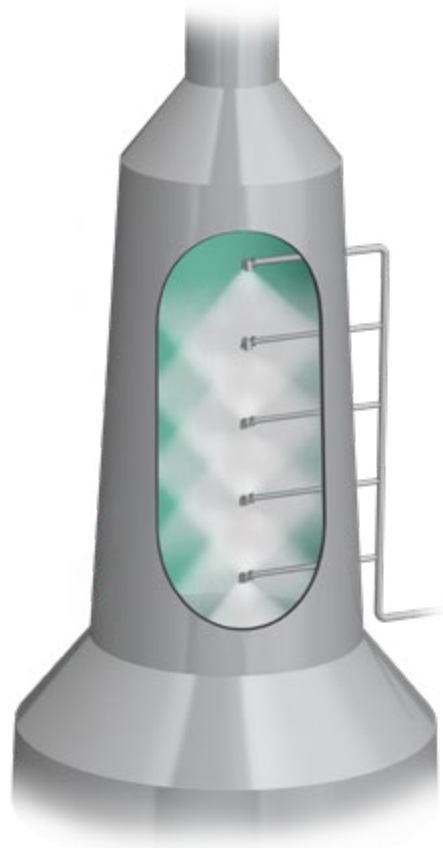

## Process-oriented nozzle configuration

- Highly efficient secondary atomization
- Better cooling
- Better cleaning
- Better dust reduction
- Improved mass transfer
- Supports better gas distribution
- Swirl compensation

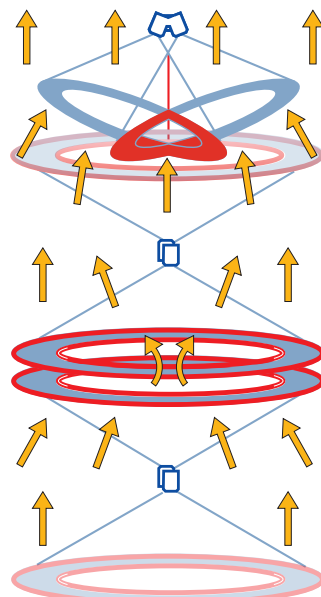

# ➤ TwinAbsorb

## Double full/hollow cone nozzle

The proven TwinAbsorb full/hollow cone nozzle generates two spray cones from only one supply. The nozzles are adapted specifically to requirements. They are cast from one piece and therefore have better wear and corrosion properties than conventional nozzles with inlays, for example.

- Finer droplets (SMD  $d_{32}$ ) due to doubling of the spray cones
- Particularly advantageous, not only for high flow rates per nozzle
- Improved mass transfer due to higher relative speeds in relation to the gas flow
- Supports uniform gas distribution over the scrubber cross-section
- No additional swirl introduced into the gas flow
- Better coverage of the scrubber wall zone
- Optimized secondary atomization through doubling of the collision areas
- Highly efficient generation of tiny droplets without additional energy input
- Increased turbulence in the droplets for more active mass transfer
- Improved coverage of the scrubber cross-section
- Reduced torque acting on the pipelines
- Preservation of the positive characteristics of standard tangential flow full cone nozzles:
  - Self-draining
  - Large clear cross-sections
  - Non-clogging design



**In addition to the TwinAbsorb series, Lechler also offers a comprehensive range of nozzles for flue gas desulfurization in a wide range of designs and materials that are exactly tailored to your specific application.**



**Nozzles made of  
SIC, stainless steel, plastics**



**Nozzles made of  
SISIC, stainless steel, plastics**



**Helix nozzles made of  
SISIC/ReSIC, stainless steel, plastics**

### Talk to us

Do you require an option that is not listed? Or are you having planning issues? No problem. Tell us what your requirements are. We will find the appropriate solution and ensure a seamless integration.



# STANDARD NOZZLES FOR A WIDE RANGE OF APPLICATIONS

In addition to the described nozzles, Lechler offers a wide range of standard nozzles that have proven themselves many times over. They can be used in a wide variety of applications and are characterized by their uniform spray pattern even under difficult conditions.

## Eccentric hollow cone nozzles

### Series 373 Ramp Bottom

#### Properties:

- Fine, uniform atomization even at low pressures
- Long service life thanks to patented swirl chamber with ramp
- Clogging-resistant thanks to large clear cross-sections

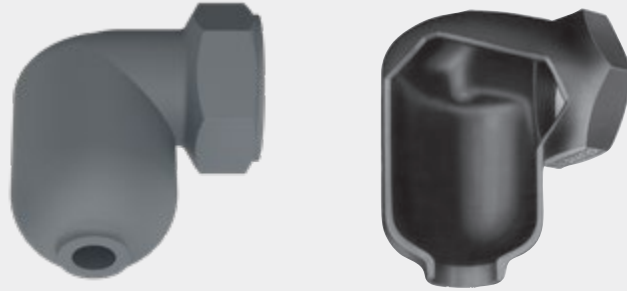

The Ramp Bottom design permits longer service lives thanks to the patented swirl chamber with ramp.

## Axial-flow full cone nozzles

### Series 419 FreeFlow

#### Properties:

- Clogging-resistant thanks to very large clear cross-sections
- Very stable spray angle
- Uniform liquid distribution
- Suitable for scrubbers



The 419 FreeFlow series is available in the material stainless steel with various connections.

## Axial-flow full cone nozzles

### Series 490/491

#### Properties:

- Particularly uniform liquid distribution
- Long service lives thanks to solid swirl inset



The series are available with different connections for a wide pressure range.

## Axial-flow full cone nozzles

### Series 403/405

#### Properties:

- Particularly uniform liquid distribution



The 403 series is available in the material stainless steel as 90° and 120° versions.



The 405 series is available in various materials as 60°, 90° and 120° versions.

# ➤ DROPLET SEPARATOR SYSTEMS – WHEN PERFORMANCE COUNTS

Droplet separators have long played a vital role in many operating processes and gas cleaning plants as functional elements that protect downstream installation parts, increase product yield or reduce energy consumption. They are now becoming even more important due to increasingly stringent environmental protection regulations that require a drastic reduction in the residual pollutant content.

This makes it necessary to use high-performance droplet separators which are capable of separating even the finest droplets with a size of less than 10 micrometers, while at the same time

minimizing pressure losses. This task requires effective separation systems with compact dimensions that can deal with high flow rates. When designing and planning droplet separators, it is necessary to have exact knowledge of the functional and performance data of the separation system as well as an in-depth process understanding of the respective application. Know-how about droplet formation and droplet movement in a gas flow is essential to ensure fault-free operation of the droplet separator. For more than 100 years now, we have worked on detection, measurement and definition of droplets. It is therefore not by chance that Lechler nozzles and Lechler droplet separators are now considered integral elements in process engineering.

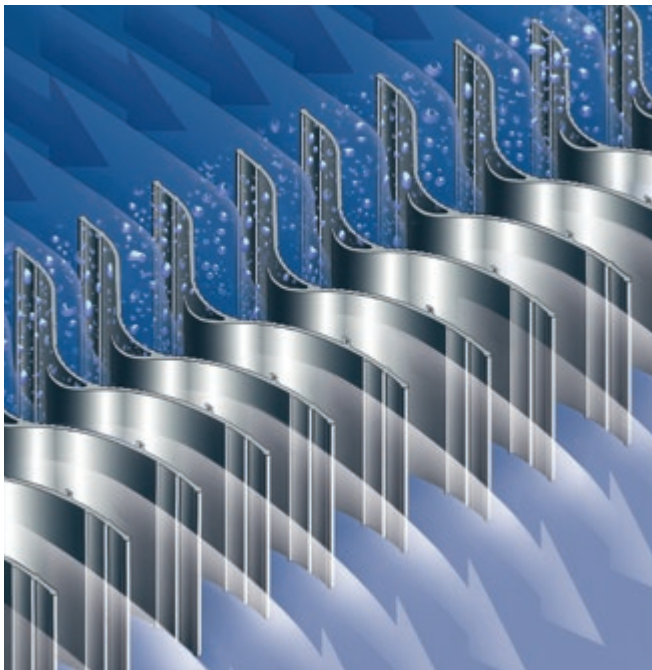

Each installation requires a specific droplet separator design and construction. Design, construction and selection of the optimum Lechler droplet separators are based fully on your requirements, specifications and drawings. That is why we do not offer standard solutions, but customize systems individually for your specific needs.

In order to guarantee fault-free operation, materials must be used that are matched to the relevant variables of the installation in question. For this reason, Lechler offers a wide range of different materials – also from stock.

## The available materials include

- Stainless steels in a lot of steel grades like 304, 316L, 316Ti, 318LN, 904L as well as special alloys such as Hastelloy
- Plastics such as PP, PPTV, PE, PVDF

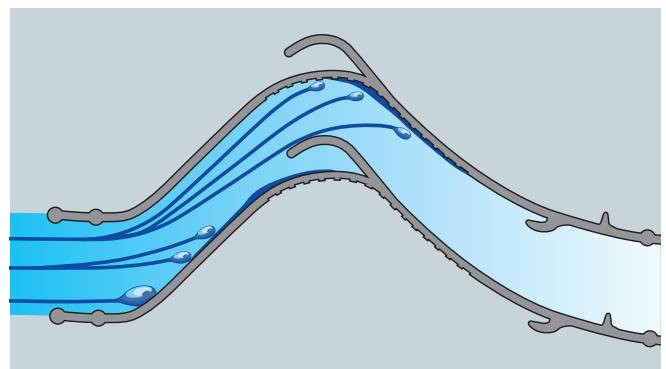
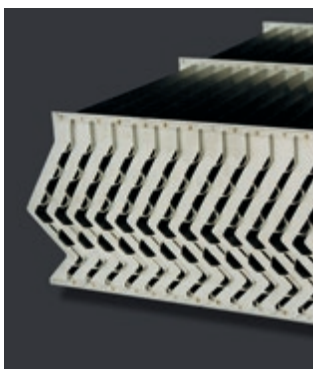

## Talk to us

Do you know your process but are not sure which droplet separator is best suited for your purposes? No problem. Based on your individual requirements, we will choose from a finely graded range of vane profiles with single or multiple deflection.



## ➤ Droplet separators for vertical gas flow

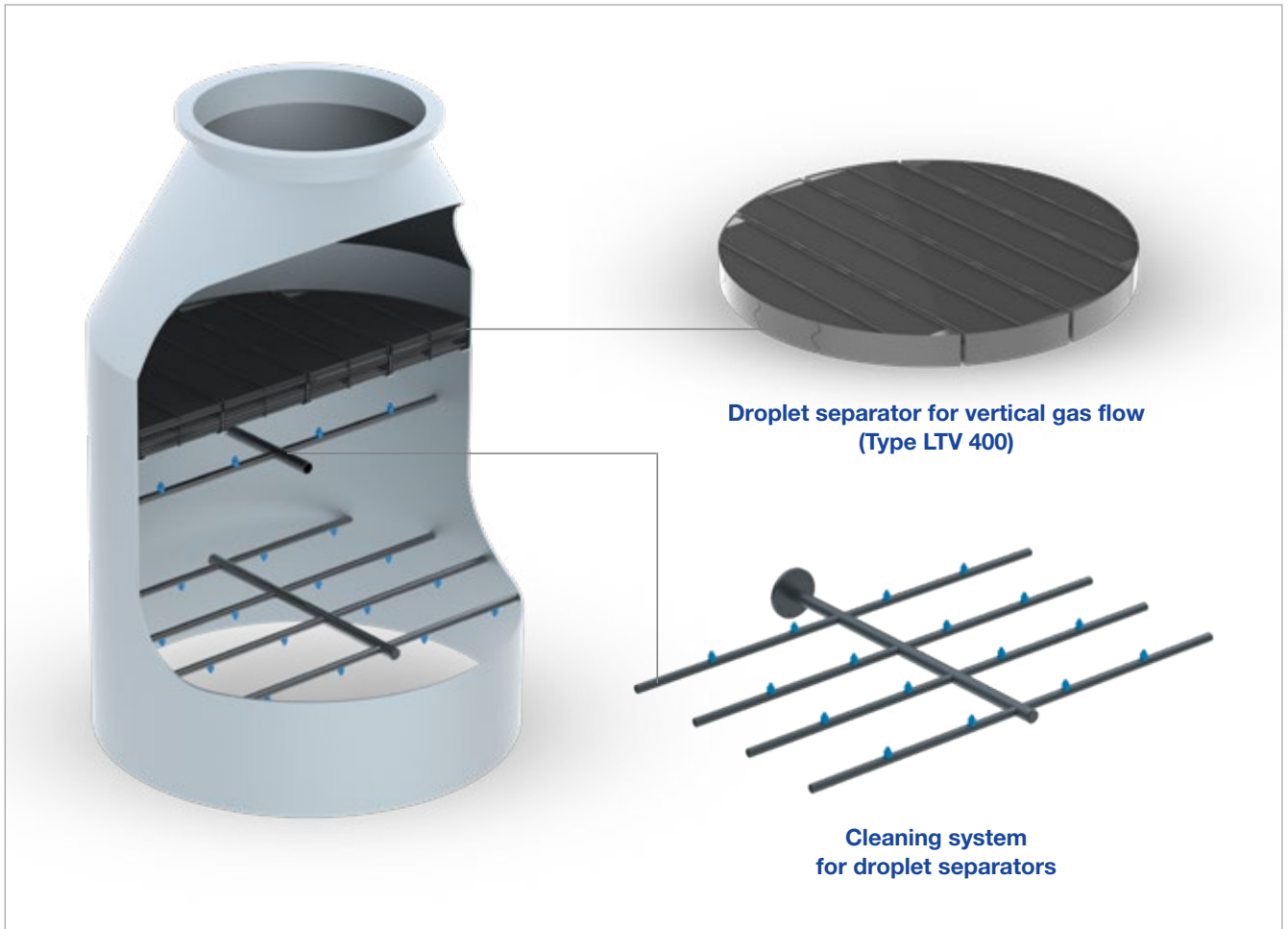

In **vane-type separators with vertical gas flow**, the baffle vanes are arranged horizontally or at a slight angle to the horizontal. The liquid that is separated at the profile forms a film which drains downwards in the opposite direction to the gas flow. This liquid film interacts with the opposing gas flow. At the bottom end, larger droplets are formed from the liquid film which then fall down.

### Reliable operation – even under tough conditions

Lechler droplet separators are characterized by their flow-optimized design. However, if the gas flows are heavily laden with dust, deposits can occur under unfavorable conditions which impair the efficiency of the droplet separators. In this case, an additional cleaning system helps guarantee continuous operation.

An arrangement that performs cyclical washing of the droplet separators with full-cone nozzles has proven particularly suitable for this. This allows you to increase functional reliability, avoid encrustations and also ensure that your plant operates with optimum efficiency over long periods.

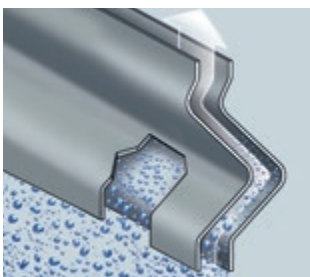

LTV 271 profile geometry

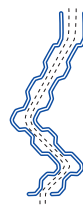

LTV 300 profile geometry



LTV 400 profile geometry

## ➤ Droplet separators for horizontal gas flow

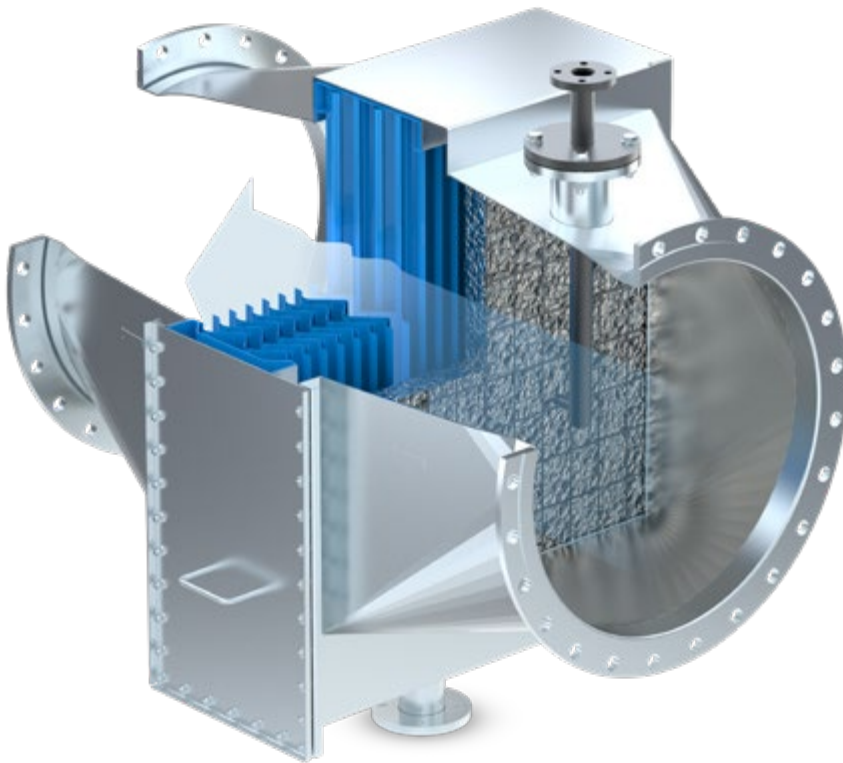

**Housing with droplet separator for horizontal gas flow (Type LTH 600) and agglomerator**



**Droplet separator for horizontal gas flow (Type LTH 600)**

**Vane-type separators for horizontal gas flow** use different design features for secondary separation than vertical systems. In vane-type separators for horizontal gas flow, the separation vanes are arranged vertically to the gas flow so that the liquid runs down the baffles due to gravity. The creation of flow-calmed zones allows the liquid film to specifically drain in these areas without renewed contact with the gas flow. The fact that liquid run-off is assisted by the forces of gravity results in

high-performance separation systems. Depending on the separator design, particularly high flow rates are possible. The flow-optimized shape of the baffle vanes minimizes pressure losses.

Based on your individual requirements, you can choose from a finely-graded range of vane profiles with single or multiple deflection.

## Extreme droplet separation

### Ultra-fine droplets

In some applications, it is necessary to separate droplets that are significantly smaller than the limit droplet diameter of a vane-type droplet separator.

In these cases, we use fiber packs as agglomerators in combination with vane-type separators.

### Large liquid volumes

Optimum pre-separation is necessary if there are liquid surges in the inlet. The Lechler Inlet Device (LID) separates large liquid quantities with maximum efficiency and thus optimizes the flow of the rising gas.

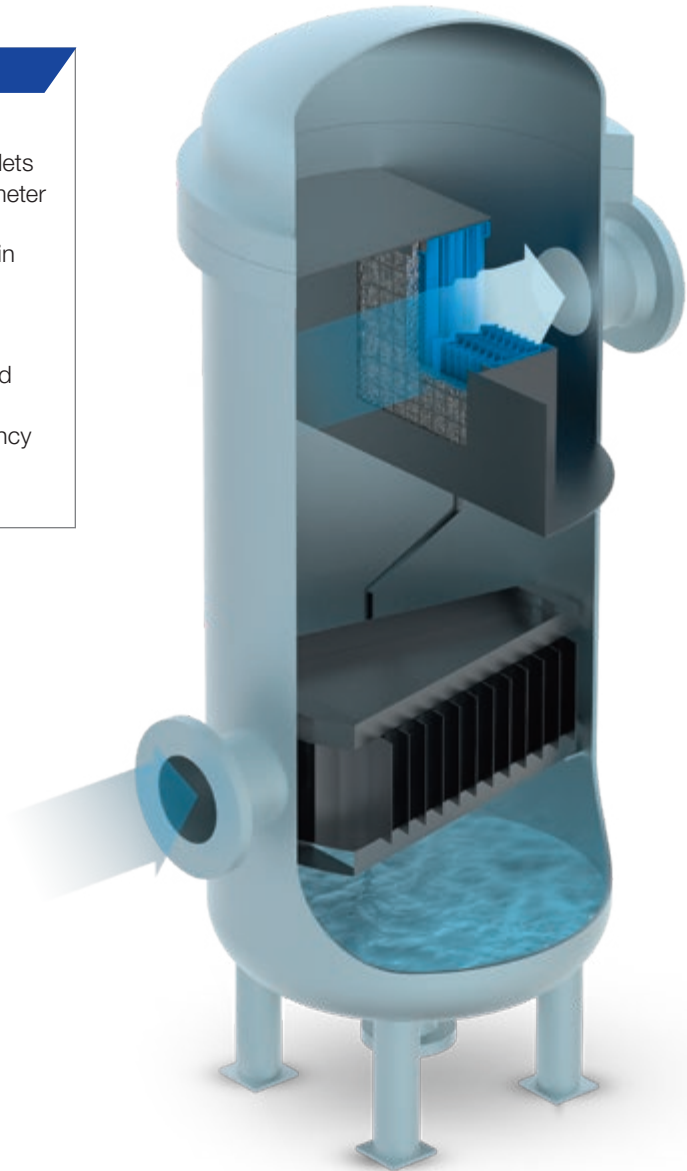
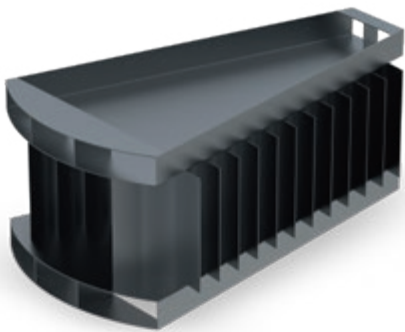

Pressure tank with an inlet device for separation of surge liquids



LTH 100 profile geometry

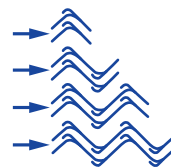

LTH 500 profile geometry

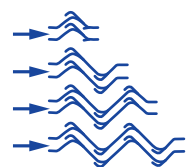

LTH 600 profile geometry



## CFD ANALYSIS

# FLOW OPTIMIZATION WITH COMPUTATIONAL FLUID DYNAMICS

No matter what the spray application, the goal is always to achieve the maximum effect with the minimum possible use of material, spray media and energy. It is therefore essential to have a detailed understanding of how spray mist is formed and propagated. This is made possible by computer-aided simulation of the flow processes (CFD – computational fluid dynamics) of one or more substances in static or dynamic environments taking into account heat and mass transfer.

These simulations incorporate our many decades of know-how from the field of nozzle development. Initially, CFD was only an internal tool which helped us to develop a desired nozzle more quickly and precisely. The completion of our high-performance cluster with a processing power of around 8,500 GFlops means that we can now offer our know-how as a service. We simulate nozzle applications and processes individually for your environment and your requirements. So that your processes also run perfectly in real life.

### Our services

- Calculation of the flow field including pressure losses with one or more flowing media in pipes and fittings
- Spray propagation including heat and mass transfer with the surrounding gases under practically all conceivable ambient conditions
- Calculation of internal nozzle flows and prediction of the spray pattern, water distribution and spray characteristics down to droplet sizes in the near-nozzle range

### Your advantages

- Maximum efficiency as regards:
  - the use of expensive consumable media
  - geometric dimensions of the overall spray process
- Maximum efficiency through targeted optimization of:
  - nozzle selection
  - nozzle operating point (taking into account your pumps, compressors and blowers)
  - liquid distribution
  - droplet sizes
  - inflow and outflow of your process gases in relation to the spray process (with the aim of achieving uniformity and reducing pressure losses)



## Construction

The flow behavior of gases is significantly determined by the geometry of the environment. By applying computer simulation using computational fluid dynamics (CFD), our specialists can detect unequal gas distributions as well as turbulence. Depending on the specific conditions, these issues can be resolved in different ways. Installing baffles, perforated plates or even repositioning nozzles can be simulated to achieve the desired flow characteristics. The result of optimized gas flow via CFD can significantly reduce energy and/or material requirements.

### Optimization of the gas flow in the gas cooling tower

#### Benefits:

- Efficient cooler operation thanks to lower atomizing air consumption and/or lower connection pressures at the nozzle lances
- Wet ground avoided as well as possible caking on the inner wall of the cooler
- Stable process in various load cases

#### Before

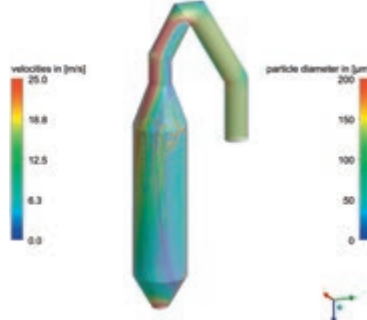

#### After

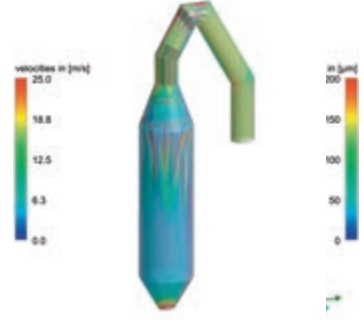

### Optimization of SNCR process – best possible selection and placement of nozzles

#### Benefits:

- Reactive ammonia vapor is present where the gas containing nitrogen (NO<sub>x</sub>) flows
- Avoidance of unnecessary NH<sub>3</sub> slip, meaning efficient use of the ammonia solution
- Best possible reduction rates of nitrogen oxides

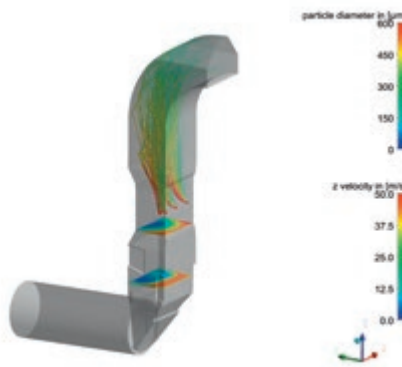

### Design and continuous optimization of our products

#### Benefits

- Optimal atomization effect
- Efficient use of the connected atomization media
- Reduction of the required nozzle connection pressures
- Individual nozzle development in the shortest time

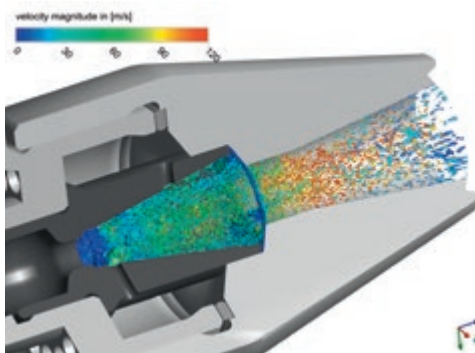





# MEASURING TECHNOLOGY HOW OUR RESOURCES HELP US ACHIEVE PRECISION



## **The basis for precision nozzle development**

At Lechler, exact measurements have long been the basis for clearly defined spray characteristics. The data obtained in our laboratories form the foundation for any development and make it easier for our customers to choose nozzles for specific applications. This saves time, lowers costs and provides planning security.

## **Advanced technology**

We have further expanded our research capacities by opening our own Development and Technology Center.

On an area of 600 m<sup>2</sup>, we can measure the velocity and size of individual droplets in sprays, determine distribution gradients and also analyze large-volume structures. In addition, different injection processes can be reproduced and compared in a test gas cooler.

## **International cooperation**

We at Lechler value the importance of international cooperation. For this is often what opens up new perspectives on a problem. In addition, cooperation offers us the possibility of testing nozzles in very special test environments and of discovering new use scenarios in this way.





## Our experience for your success

With our experienced engineering team, you have a competent contact for your project at all times – from technical design and detail engineering to commissioning and replacement of spare and wearing parts. You will benefit from direct contact and fewer communication channels to enable smooth completion of your project.

## Exclusive solutions

Lechler offers a system solution tailored to your application and plant-specific conditions. We use only high-quality components from renowned manufacturers for our valve skid units. If you choose a system with a control, you will get a complete solution for your gas cooling and conditioning requirement from a single source.

## Reliable service is part of our agreement

For even after your system has been delivered, you are in good hands with Lechler. We offer a worldwide commissioning service provided by employees with many years of experience. A signal and performance test ensures optimal system operation taking all operating and safety aspects into consideration. An important point of commissioning is also the detailed briefing of operating and maintenance personnel in the operation and maintenance of the plant.

We are your competent partner who will provide you with assistance to solve your problems. Our on-site service for preventive maintenance ensures continuous operation. We will be more than happy to draw up a maintenance contract tailored to your needs.

## From digital to real

Each individual design of gas cooling and conditioning systems is based on innovative software. CFD calculations are used for flow optimization. Using a 3D tool, we identify the optimum liquid distribution in the duct together with the necessary lance arrangement. Our drawings are created using state-of-the-art design engineering software.

## Extensive documentation

Our nozzle lances and systems are designed and manufactured in line with the current standards and regulations. New plants are always delivered with project-related documentation containing all relevant information for commissioning, operation and maintenance. Lechler will also provide a verbal description of the function and control concept where desired.

## Future-proof

Lechler systems are built to withstand harsh conditions and enable reliable and long-term operation. But we too have to lend to the extreme process conditions in the power plant industry. Which is why it is all the more important to us to have a guaranteed long-term supply of spare parts for wearing parts – worldwide. With our global network of representatives, we offer a worldwide platform for contact and advice. You will find your competent contacts on the Lechler website.

**ENGINEERING  
YOUR SPRAY SOLUTION**



**Lechler GmbH · Precision Nozzles · Nozzle Systems**

**Ulmer Strasse 128 · 72555 Metzingen, Germany · Phone +49 7123 962-0 · info@lechler.de · www.lechler.com**

**ASEAN:** Lechler Spray Technology Sdn. Bhd. · No. 23 Jalan, Teknologi 3/3A · Kota Damansara · 47810 PJ, Malaysia · Phone +603 6142 1288 · info@lechler.com.my

**Belgium:** Lechler S.A./N.V. · Avenue Newton 4 · 1300 Wavre · Phone +32 10 225022 · info@lechler.be

**China:** Lechler Nozzle Systems (Changzhou) Co., Ltd. · No.99 Decheng Rd, Jintan, Changzhou, JS 213200, P.R.C · Phone +86 519-6822 8088 · info@lechler.com.cn

**Finland:** Lechler Oy · Ansatie 6 a C 3 krs · 01740 Vantaa · Phone +358 207 856880 · info@lechler.fi

**France:** Lechler France SAS · Bât. CAP2 · 66-72 Rue Marceau · 93100 Montreuil · Phone +33 1 49882600 · info@lechler.fr

**Great Britain:** Lechler Ltd. · 1 Fell Street, Newhall · Sheffield, S9 2TP · Phone +44 114 2492020 · info@lechler.com

**India:** Lechler (India) Pvt. Ltd. · Plot B-2 · Main Road · Wagle Industrial Estate Thane · 400604 Maharashtra · Phone +91 22 40634444 · lechler@lechlerindia.com

**Italy:** Lechler Spray Technology S.r.l. · Via Don Dossetti, 2 · 20080 Carpiano (MI) · Phone +39 2 98859027 · info@lechleritalia.com

**Russia:** Lechler Rus · OOO, 108811, Moscow, Settlement Moskowskiy, Kiewskoe Chaussee km 22 · Object 4, Bld. 2, Block G, Floor 6, Office 601/G · info@lechler-rus.ru

**Spain:** Lechler, S.A. · C / Isla de Hierro, 7 – Oficina 1.3 · 28703 San Sebastián de los Reyes (Madrid) · Phone +34 91 6586346 · info@lechler.es

**Sweden:** Lechler AB · Kungsängsvägen 31B · 753 23 Uppsala · Phone +46 18 167030 · info@lechler.se

**USA:** Lechler Inc. · 445 Kautz Road · St. Charles, IL 60174 · Phone +1 630 3776611 · info@lechlerusa.com

