

Plastic disc springs



iglidur® J



iglidur® A500



Order key

Type Dimensions [mm]

T E M-05

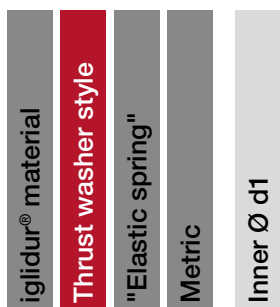

Options:  
**iglidur® J**  
 for low wear  
**iglidur® A500**  
 for high temperature applications requiring FDA-compliance



Material:  
 iglidur® J ▶ Page 159  
 iglidur® A500 ▶ Page 393

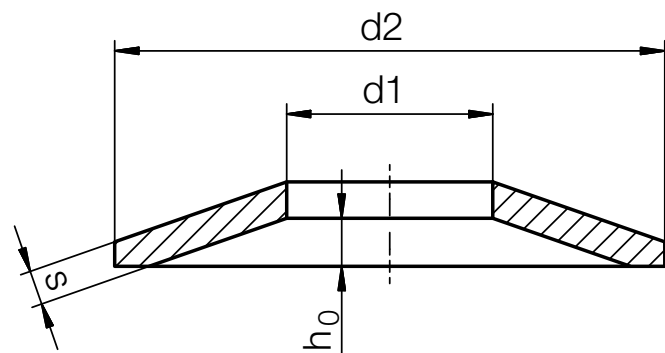

Dimensions based on DIN 2093

Dimensions [mm]

d1	d2	s	h <sub>0</sub>	Standard values: Spring lengths and forces		Weight [g]	Part No. <sup>15)</sup>
				F <sub>1,0</sub> iglidur® J [N]	F <sub>1,0</sub> iglidur® A500 [N]		
5.2	10.0	0.5	0.25	5	8	0.04	<input type="checkbox"/> TEM-05
6.2	12.5	0.7	0.30	10	15	0.11	<input type="checkbox"/> TEM-06
8.2	16.0	0.9	0.35	16	24	0.20	<input type="checkbox"/> TEM-08
10.2	20.0	1.1	0.45	24	35	0.33	<input type="checkbox"/> TEM-10
12.2	25.0	1.5	0.55	45	70	0.85	<input type="checkbox"/> TEM-12
16.3	31.5	1.75	0.70	65	85	1.44	<input type="checkbox"/> TEM-16
20.4	40.0	2.25	0.90	130	150	3.10	<input type="checkbox"/> TEM-20

The standard values for the spring lengths and forces are rounded mean values.

<sup>15)</sup> Material: iglidur® J: JTEM, standard  
 iglidur® A500: A500TEM, high temperature and chemical resistance

Symbols and units:

- F = Force [N]
- h<sub>0</sub> = Maximum spring displacement [mm]
- F<sub>1,0</sub> = Spring force 100% displacement [N]

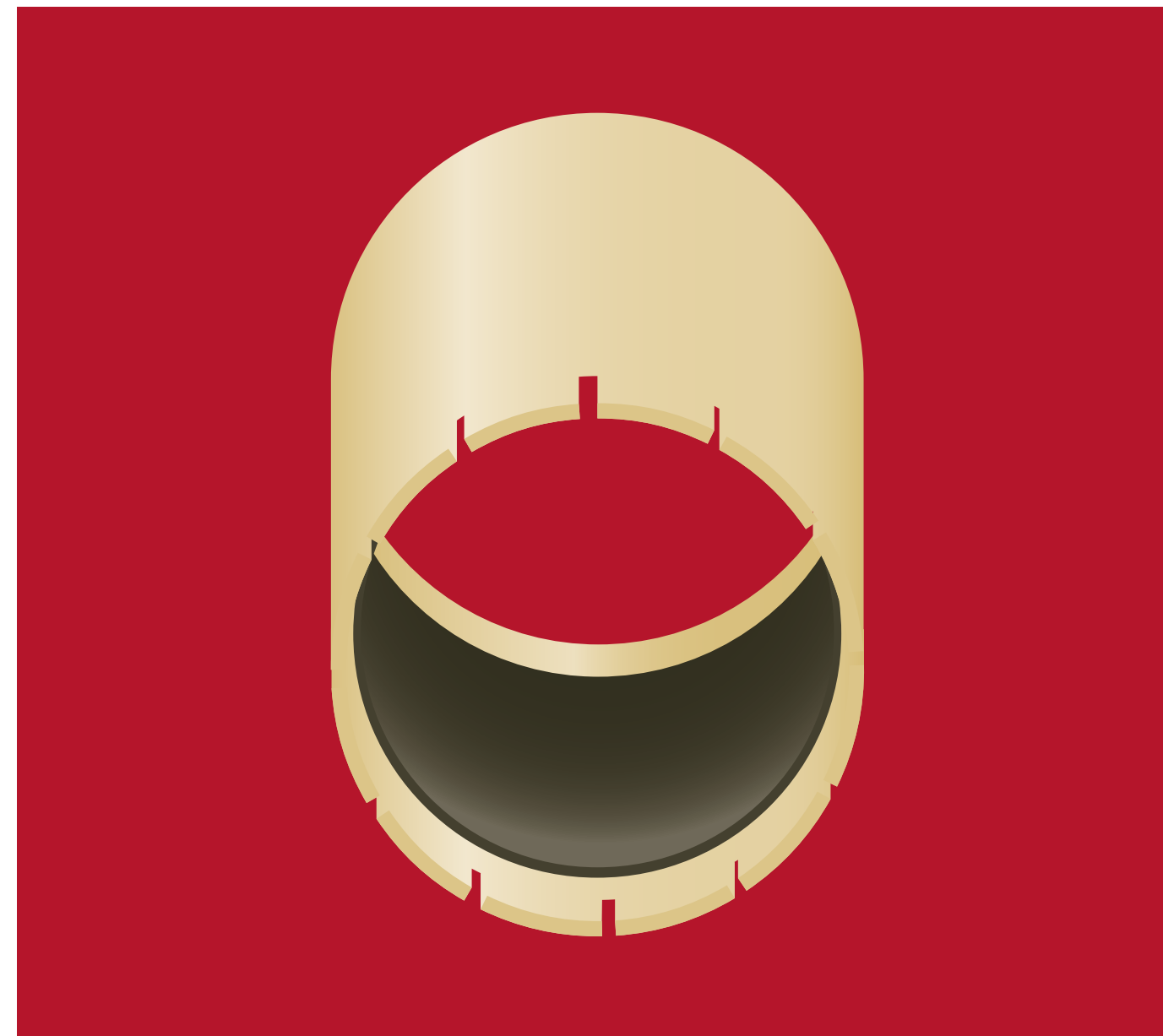

# iglidur® PEP multi-component bearings

Can be used with any shaft material

Cost-effective

Easy installation

Low coefficient of friction

Standard range from stock



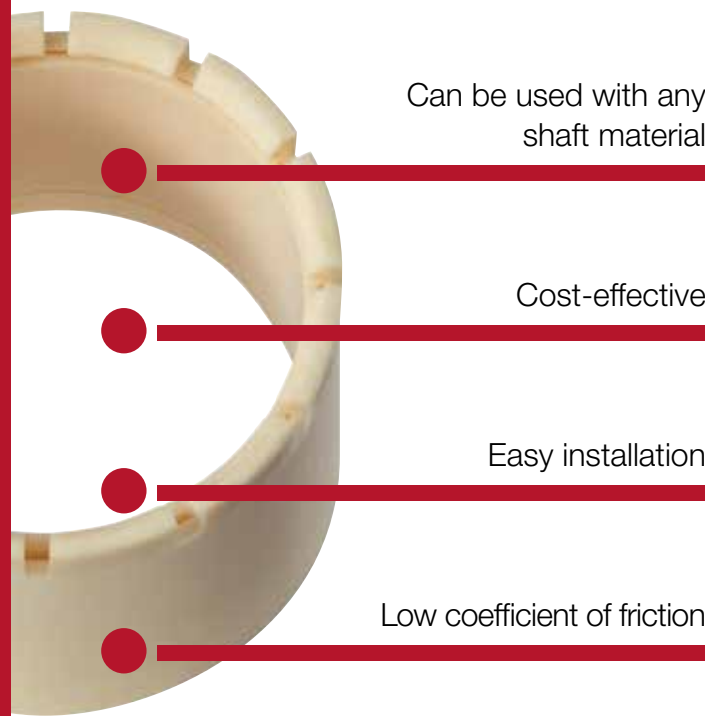

## iglidur® PEP multi-component bearings

In standard plain bearing solutions, the shaft has a critical part to play, as important as the bearing itself. With the iglidur® PEP bearings, igus® is forging new trail with this enclosed and maintenance-free plain bearing design.



### When to use it?

- When a cost-effective plastic plain bearing system is required
- When independence from the shaft material and shaft surface is required
- For the protection of expensive and sensitive shafts



### When not to use it?

- For high surface speeds
  - ▶ iglidur® J, page 159
- At high loads
  - ▶ iglidur® G, page 81
  - ▶ iglidur® Q, page 459
- At high temperatures
  - ▶ iglidur® V400, page 307
  - ▶ iglidur® X, page 279
  - ▶ iglidur® Z, page 289
- When low clearance bearings are required
  - ▶ iglidur® P, page 131
  - ▶ iglidur® X, page 279



1 type  
Ø 6–20mm

More dimensions upon request



Imperial dimensions available  
▶ From page 1605



Available from stock

Detailed information about delivery time online.



Material:  
iglidur® J ▶ Page 159



Max. +90°C  
Min. -50°C

616 Online tools and more information ▶ [www.igus.eu/pep](http://www.igus.eu/pep)



### General properties

Maintenance-free plain bearings are generally described as being able to slide on the shaft without any additional coating and/or lubrication. It is evident that shaft materials are as important as the plain bearing itself. igus® is forging a new path with a plain bearing that is self-contained and maintenance-free.

iglidur® PEP is an innovative design for lubrication-free plastic plain bearing systems with an inner and outer ring. The special feature; the sliding surface is the inner ring, and for the first, time shaft materials and shaft surfaces are not a concern. Even threads, rust and scratches do not affect the performance or reliability. With the control over the sliding surface and through considerable testing, the long-term behaviour of the bearing system can be predicted precisely. Similar to ball bearings, the inner ring turns with the shaft in the plastic PEP plain bearing. Relative movements of the shaft with respect to the bearing are eliminated. This protects the shaft surface from wear and saves costs. An additional benefit; even the most sensitive or unusual materials can be used as the rotating shaft with this polymer plain bearing. Due to the bearing materials used, the PEP plastic bearing is totally corrosion-free.

### Wear resistance

For loads up to 5N/mm<sup>2</sup> the wear test results are compelling. Here PEP plastic bearings obtain values that are comparable to most wear-resistant metal-backed bearing systems. This is a very positive result, when you consider the reduced costs compared with the required shaft surface finish which is demanded by traditional bearings. The consistently low coefficient of friction is also an advantage to the user. Since the running surfaces are fixed, the tribological data can be calculated. The coefficient of friction of the lubrication-free PEP bearings is no longer based on the shaft materials or surface properties. If necessary, the coefficient of friction can be reduced further with a small amount of lubricant.

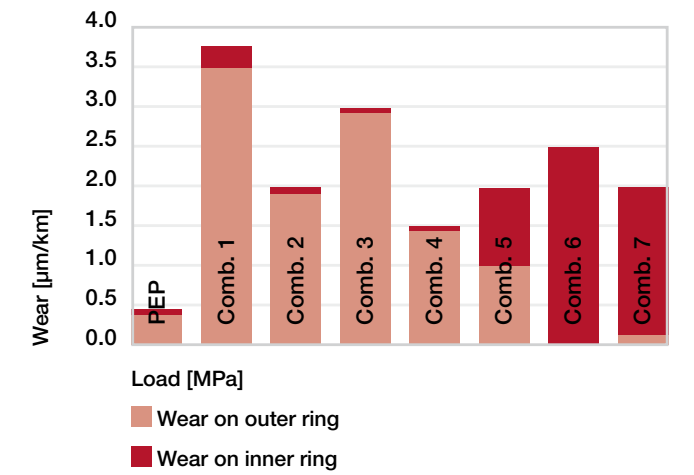

Diagram 01: Wear experiments of different material combinations, p = 0.75MPa, v = 0.3m/s

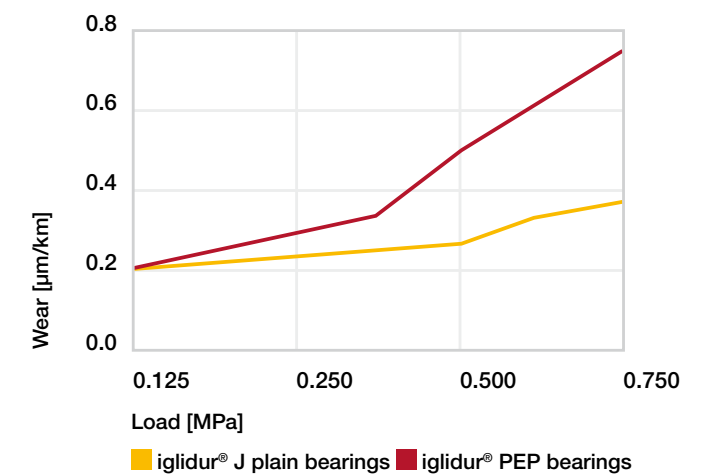

Diagram 02: Wear of iglidur® PEP bearings as a function of the load, v = 0.3m/s

### Assembly

The installation of the PEP plain bearing could not be easier or faster. The bearings are manufactured to be press-fitted into a recommended housing hole of H7 tolerance. Then, the shaft is inserted and fits tightly onto the inner ring. The inner bearing is clipped into the outer ring. This design makes it possible to pull the shaft out without removing the inner ring.

616 Online tools and more information ▶ [www.igus.eu/pep](http://www.igus.eu/pep)



3D CAD files, prices and delivery time online ▶ [www.igus.eu/pep](http://www.igus.eu/pep) 617



Order key

Type  Dimensions [mm]

PEP S M-0610-10

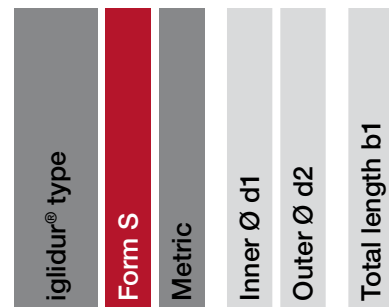

Material:  
iglidur® J ► Page 159

Imperial dimensions available  
► From page 1605

Dimensions [mm]

d1	d2	b1	Part No.
6	10	10	PEPSM-0610-10
8	12	12	PEPSM-0812-12
10	14	12	PEPSM-1014-12
12	16	15	PEPSM-1216-15
16	20	20	PEPSM-1620-20
20	23	20	PEPSM-2023-20



## iglidur® lip seal bearings

Polymer bearing with integrated radial shaft seal

Seals against the shaft

Reduced space requirement and easy, fast installation

Can be manufactured with different types of seal

High temperature option available (VDSM)

