



HENNLICH

MERES

HLADINOVÝ SPÍNAČ S TANDEM PLVÁKY T20/T21

DESCRIPTION

T20 and T21 units are simple, reliable float switches designed for top mounting into tanks or vessels. T20 units utilize a single switch mechanism and float. T21 units utilize two switch mechanisms and two separate floats when widely spaced actuating levels are required. T20 and T21 models are available for any type of open or closed vessel with either threaded or flanged type mounting and actuating depths up to 1219 mm (48 inches).

FEATURES

- Carbon or stainless steel process connection materials (other materials available at request)
- Flanged and threaded process connections
- Wide choice of housings and switch mechanisms
- Process temperature up to 540 °C (1000 °F)
- Up to 2 switch levels (T21)
- Specific gravity as low as 0,60
- Process pressure up to 41,3 bar (600 psi)
- Standard anti corrosive protection
- Custom calibrated

Optional:

- NACE construction
- Interface calibration
- Special tank connections
- Elevated temperature
- Special exterior surface preparation and finish
- Stilling well
- Tropicalized switch mechanism
- Submersible housing

APPLICATIONS

- Day Tanks
- Condensate Receivers
- Fuel Storage Tanks
- Cooling Towers
- Flash Tanks
- Interface
- High and high/high alarm from single tank entry

Float level switches for single or dual level alarm



PRINCIPLE OF OPERATION

A permanent magnet ① is attached to a pivoted switch actuator and adjustment screw ②. As the float ③ rises following the liquid level, it raises the attraction sleeve ④ into the field of the magnet, which then snaps against the non-magnetic enclosing tube ⑤, actuating the switch ⑥. The enclosing tube provides a static pressure boundary between the switch mechanism and the process. On a falling level, an inconel spring retracts the magnet, deactivating the switch.

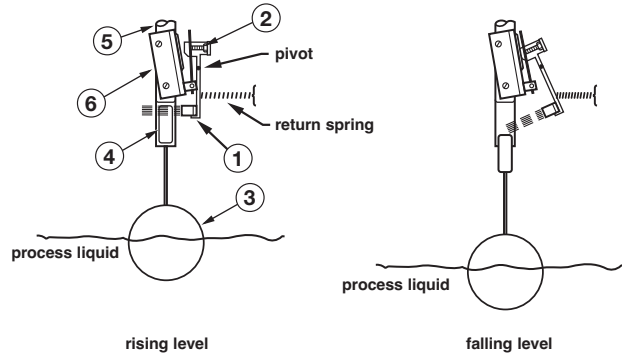

MOUNTING

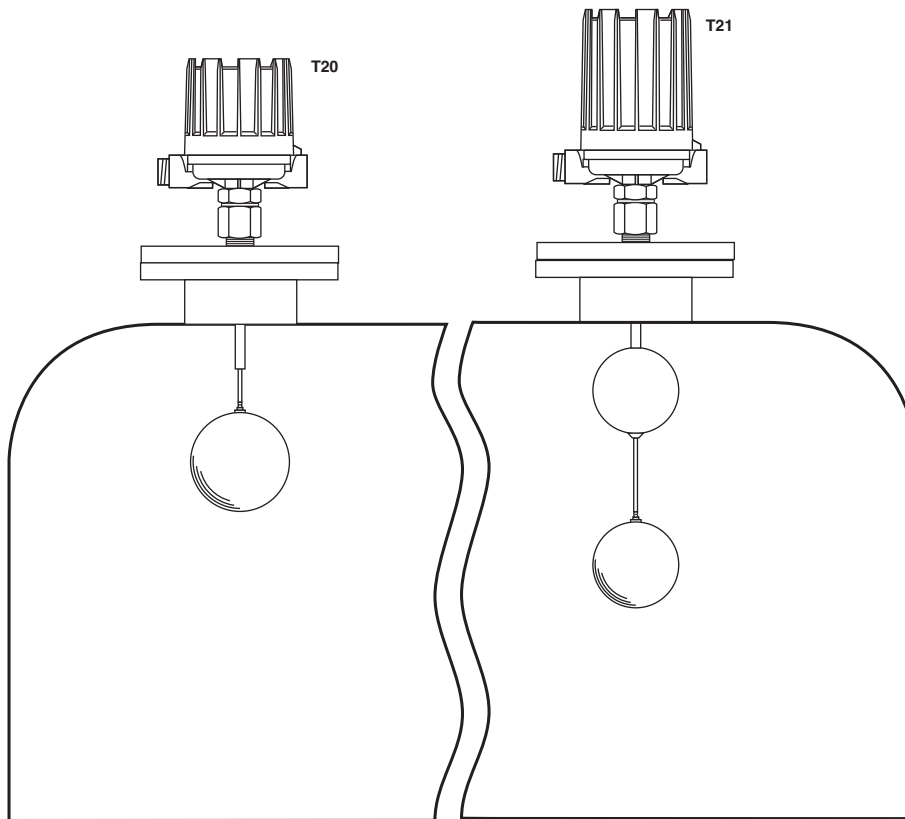

T20 – SINGLE SWITCH MODEL

Level alarm applications
Narrow differential type







These instruments are factory calibrated to operate over a narrow level differential band and are ideally suited for liquid level alarm applications, on either high or low level.

T21 – DUAL SWITCH MODEL

Level alarm applications
Narrow differential type

T21 tandem models combine the functions of two separate narrow differential level controls in a single, compact, easy to install instrument. Two individual switch mechanisms are employed to provide two actuating levels at least 203 mm (8") apart. These instruments are ideally used in applications requiring two separate switching points, such as high and low level alarm operation.

AGENCY APPROVALS

AGENCY	APPROVED MODEL	AREA CLASSIFICATION
ATEX 	All with electric switch mechanism and housing listed as ATEX Ex d	ATEX II 2 G Ex d IIC T6 Gb
	All with electric switch mechanism and housing listed as ATEX Ex ia	ATEX II 1 G Ex ia IIC T6 Ga
FM 	All with electric switch mechanism and housing listed as NEMA 7/9	Class I, Div 1, groups C & D Class II, Div 1, Groups E, F & G
	Consult factory for proper model numbers	Class I, Div 1, groups B, C & D Class II, Div 1, Groups E, F & G
IECEX 	All with electric switch mechanism and housing listed as IECEX Ex d	Ex d IIC T6
	All with electric switch mechanism and housing listed as IECEX Ex ia	Ex ia IIC T6 Ga
CSA 	Consult factory for proper model numbers	Class I, Div 1, groups C & D Class II, Div 1, Groups E, F & G
	Consult factory for proper model numbers	Class I, Div 1, groups B, C & D Class II, Div 1, Groups E, F & G
EAC (Russia, Kazakhstan, Belarus) 	All with electric switch mechanism and housing listed as ATEX Ex d	1Ex d IIC T6 Gb
	All with electric switch mechanism and housing listed as ATEX Ex ia	0Ex ia IIC T4 Ga
LRS 	Lloyds Register of Shipping	Marine approval
CE 	The units are conform to the ATEX directive 2014/34/EU, PED directive 2014/68/EU, Low Voltage Directive 2014/35/EU and RoHS directive 2011/65/EU	
Other approvals are available, consult factory for more details		

SWITCH MECHANISMS AND HOUSINGS

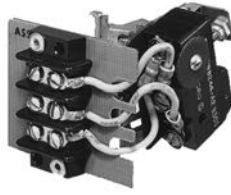

Series B, C, D, R & U Dry contact switches ^①

- Series B and C switches are general purpose units with a selection of maximum liquid temperature ratings
- Series D switch is designed for high DC current applications
- Series U switches have gold alloy contacts
- Series R switches are designed for the highest temperature applications up to +540 °C (+1000 °F)



Series J & K Pneumatic switches ^③

- Suited for process industry applications in hazardous locations or where electrical power is not available
- Series J bleed type switch is intended for general purpose applications
- Series K switch is specially designed to provide non-bleed operation with a high degree of vibration resistance



Series HS ^②, F, W, X, 8 & 9 Hermetically sealed switches

- Entire mechanism and contacts are contained within a positively pressurized capsule with series HS
- Ideal for use in salt and other corrosive atmospheres



Switch housings ^①

- Die cast aluminium housings
- Cast iron housings
- Stainless steel housings
- Optional housing heaters and drains available for some housings
- Pneumatic switch mechanisms available with alu base/cold rolled steel cover
- Electrical switch mechanisms for high temperature available with aluminium base / cold rolled steel cover



Series V Inductive Proximity switch ^④

- Series V switches are inductive proximity switches type SJ3,5-SN with a maximum liquid temperature rating of +100 °C (+210 °F)

Basic electrical ratings ^①

Voltage	Switch Series and Non-Inductive Ampere Rating										
	B	C	D	F	HS	R	U	W	X	8	9
120 V AC	15.00	15.00	10.00	2.50	5.00	1.00	1.00	1.00	0.50	1.00	1.00
240 V AC	15.00	15.00	—	—	5.00	1.00	—	1.00	0.50	—	—
24 V DC	6.00	6.00	10.00	4.00	5.00	1.00	1.00	3.00	0.50	3.00	1.00
120 V DC	0.50	1.00	10.00	0.30	0.50	0.40	—	0.50	0.50	—	—
240 V DC	0.25	0.50	3.00	—	0.25	—	—	—	—	—	—

^① For more details see bulletin BE 42-683

^② For more details on HS Hermetically sealed switches, see bulletin BE 42-694

^③ For more details on J & K Pneumatic switches, see bulletin BE 42-685 and bulletin BE 42-686

^④ For more details on V Inductive Proximity switches, see bulletin BE 42-798

DIMENSIONS IN mm (inches)

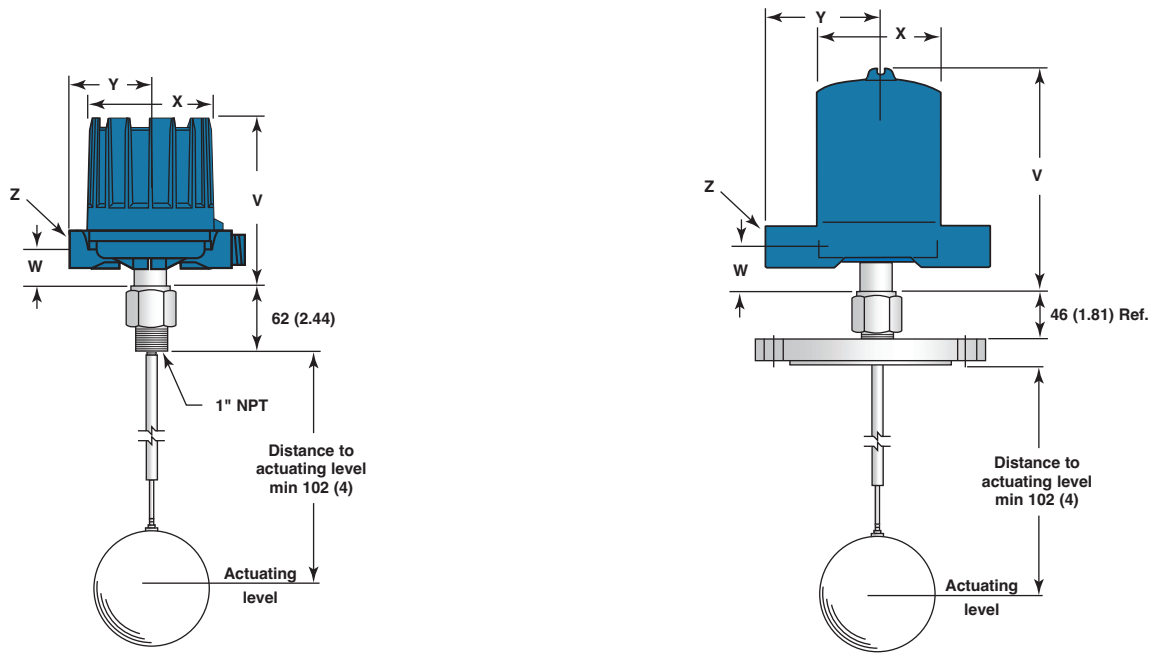

Model T20 with 1" NPT

Model T20 with flange

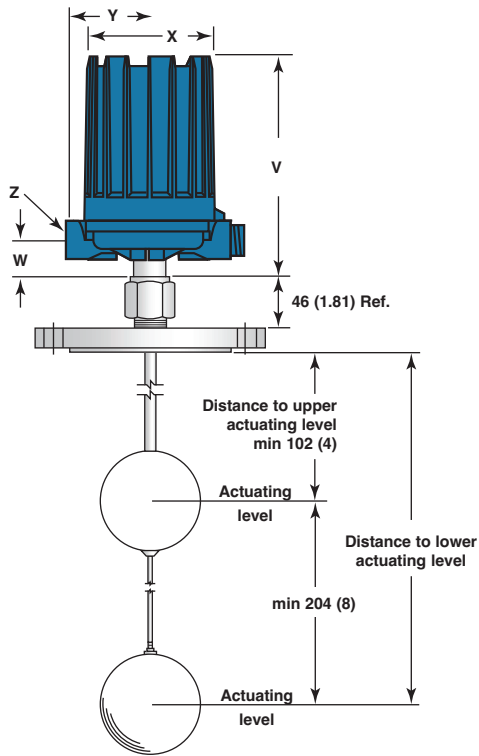

Model T21 with flange

Distance to	Maximum	Minimum
Upper level	1016 mm (40")	102 (4")
Lower level	1219 mm (48")	305 (12")

Note: On model T21, the lower float actuates the upper switch mechanism. The upper float actuates the lower switch mechanism.

Housing type	Models	V	W	ø X	Y	Z
Weatherproof-FM (NEMA 7/9) - ATEX (Cast Alu)	T21	257 (10.12)	42 (1.66)	151 (5.93)	109 (4.29)	M20 x 1,5 (*) or 1" NPT (2 entries - 1 plugged) (*) not for FM (NEMA 7/9)
	T20 with HS-switch					
	T20 excl. HS-switch					
Weatherproof (CS/Aluminium)	T20	165 (6.50)	39 (1.54)	118 (4.65)	83 (3.27)	3/4" NPT (single entry)
	T21	216 (8.50)				
ATEX (Cast Iron)	All	249 (9.80)	45 (1.77)	143 (5.63)	110 (4.33)	M20 x 1,5 or 3/4" NPT (single entry - 2 entries at request)
Pneumatics Series J Bleed Type	T20	165 (6.50)	39 (1.54)	118 (4.65)	110 (4.33)	1/4" NPT
Pneumatics Series K Non Bleed					130 (5.12)	

Allow 200 mm (7.87") overhead clearance / All housings are 360 ° rotatable

EXPEDITE SHIP PLAN (ESP)

Several models are available for quick shipment, within max. 4 weeks after factory receipt of purchase order, through the Expedite Ship Plan (ESP). To take advantage of ESP, simply match the blue model number codes.

ESP delivery is limited to a maximum of 10 units per order. Contact your local representative for lead times on larger volume orders, as well as other products and options.

SELECTION DATA T20 SINGLE SWITCH

A complete measuring system consists of:

Order code for **T20** models (each unit is factory calibrated to operate on a given specific gravity within the min and the max values listed per model)

1 - 4 | MODEL NUMBER CODE AND MATERIALS OF CONSTRUCTION

Model No.	Set points	Process /Tank connection	Float and trim	Magnetic sleeve
T20-A	1 - Single float	Carbon steel	316 SST (1.4401)	400 series SST
T20-B				316 SST (1.4401)
T20-D		316 SST (1.4401)		

Important: Actuating level, in either the rising or falling state, and specific gravity must be provided upon placement of order. The maximum available actuating level is governed by the liquid specific gravity and selected float size as given in the table below. The minimum actuating level is 102 mm (4 inches).

FLOAT SELECTION AND MAX ACTUATING LEVEL ^①

Liquid Specific Gravity	Float Size mm (inches)			
	Ø 76 x 127 (3" x 5")	Ø 89 x 152 (3 1/2" x 6")	Ø 102 (4")	Ø 114 (4 1/2")
1,00	991 (39)	1219 (48)	1219 (48)	1219 (48)
0,90	508 (20)	1219 (48)	838 (33)	1219 (48)
0,80	—	1219 (48)	279 (11)	1219 (48)
0,70	—	838 (33)	—	965 (38)
0,60	—	—	—	152 (6)

^① The minimum actuation level is 102 mm (4")

FLOAT PRESSURE RATINGS

Float Size mm (inches)	Pressure Rating bar (PSIG)			
	40 °C (100 °F)	400 °C (750 °F)	480 °C ^② (900 °F)	540 °C ^② (1000 °F)
Ø 76 x 127 (3" x 5")	34,4 (500)	26,0 (377)	24,3 (353)	23,1 (335)
Ø 89 x 152 (3 1/2" x 6")	34,4 (500)	27,7 (403)	26,7 (388)	26,4 (383)
Ø 102 (4")	41,3 (600)	33,3 (483)	32,0 (465)	31,6 (459)
Ø 114 (4 1/2")	34,4 (500)	27,7 (403)	26,7 (388)	26,4 (383)

^② Upon prolonged exposure to temperatures above 425 °C (800 °F), the carbide phase of steel may be converted to graphite. Permissible but not recommended for prolonged use above 425 °C (800 °F). (Applies to models T20-A & T20-B.)

5 - 7 | TANK CONNECTION AND FLOAT SIZE

Tank Connection	Float sizes			
	Ø 76 x 127 mm (3" x 5")	Ø 102 mm (4")	Ø 114 mm (4 1/2")	Ø 89 x 152 mm (3 1/2" x 6")
	Threaded NPT connection			
1" NPT	B2A	B2B	B2C	B2D
	ASME Flanges ^③			
4" 150 lbs RF	H3A	—	—	H3D ^④
4" 300 lbs RF	H4A	—	—	H4D ^④
5" 150 lbs RF	J3A	J3B	J3C ^④	J3D
5" 300 lbs RF	J4A	J4B	J4C ^④	J4D
6" 150 lbs RF	K3A	K3B	K3C	K3D
6" 300 lbs RF	K4A	K4B	K4C	K4D
8" 150 lbs RF	L3A	L3B	L3C	L3D
	EN 1092-1 flanges ^③			
DN 100 PN16, Type B1	8FA	—	—	8FD ^④
DN 100 PN 25/40, Type B1	8GA	—	—	8GD ^④
DN 150 PN16, Type B1	9FA	9FB	9FC	9FD
DN 150 PN 25/40, Type B1	9GA	9GB	9GC	9GD

^③ Flanges are threaded onto 1" NPT bushing

^④ Float cannot pass S160 nozzle or greater

9 - 10 | SWITCH MECHANISM & HOUSING (next page)



complete order code for T20 models

X = product with a specific customer requirement

SELECT ELECTRIC SWITCH MECHANISM & HOUSING

Switch Description	Process ^① Temperature Range °C (°F)	Contacts	T20-A Models									T20-B and T20-D Models								
			Weather proof (IP 66)	ATEX - IECEx (IP 66)						FM (IP 66)	Weather proof (IP 66)	ATEX - IECEx (IP 66)						FM (IP 66)		
				II 2G Ex d IIC T6 Gb			II 1G Ex ia IIC T6 Ga					II 2G Ex d IIC T6 Gb			II 1G Ex ia IIC T6 Ga					
				Cast Aluminium	Cast Aluminium	Cast Iron (ATEX only)	Cast Aluminium	Cast Alu.	Cast Aluminium	Cast Aluminium		Cast Iron (ATEX only)	Cast Aluminium	Cast Alu.	Cast Aluminium	Cast Aluminium	Cast Iron (ATEX only)	Cast Aluminium	Cast Alu.	
M20x1,5	1" NPT	M20x1,5	1" NPT	M20x1,5	3/4" NPT	M20x1,5	1" NPT	1" NPT	M20x1,5	1" NPT	M20x1,5	1" NPT	M20x1,5	3/4" NPT	M20x1,5	1" NPT	1" NPT			
Series B Snap switch	-40 to +120 (-40 to +250)	1x SPDT	B2P	BAP	BHC	BAC	BK7	BU7	–	–	BKP	B2Q	BAQ	BH9	BA9	BK5	BU5	–	–	BKQ
		1x DPDT	B8P	BDP	BJC	BBC	BD7	BW7	–	–	BNP	B8Q	BDQ	BJ9	BB9	BD5	BW5	–	–	BNQ
Series C Snap switch	-40 to +230 (-40 to +450)	1x SPDT	C2P	CAP	CHC	CAC	CK7	CU7	C2L	CAL	CKP	C2Q	CAQ	CH9	CA9	CK5	CU5	C2S	CAS	CKQ
		1x DPDT	C8P	CDP	CJC	CBC	CD7	CW7	C8L	CDL	CNP	C8Q	CDQ	CJ9	CB9	CD5	CW5	C8S	CDS	CNQ
Series D DC Current Snap switch	-40 to +120 (-40 to +250)	1x SPDT	D2Q	DAQ	DH9	DA9	DK5	DU5	–	–	DKQ	D2Q	DAQ	DH9	DA9	DK5	DU5	–	–	DKQ
		1x DPDT	D8Q	DDQ	DJ9	DB9	DD5	DW5	–	–	DNQ	D8Q	DDQ	DJ9	DB9	DD5	DW5	–	–	DNQ
Series F Hermetically sealed Snap switch	-45 to +400 (-50 to +750)	1x SPDT	F2P	FAP	FHC	FAC	FK7	FU7	–	–	FKP	F2Q	FAQ	FH9	FA9	FK5	FU5	–	–	FKQ
		1x DPDT	F8P	FDP	FJC	FBC	FD7	FW7	–	–	FNP	F8Q	FDQ	FJ9	FB9	FD5	FW5	–	–	FNQ
Series HS Hermetically sealed Snap switch	-45 to +290 ^② (-50 to +550)	1x SPDT	H7A	HM2	HFC	HA9	HB3	HB4	–	–	HM3	H7A	HM2	HFC	HA9	HB3	HB4	–	–	HM3
		1x DPDT	H7C	HM6	HGC	HB9	HB7	HB8	–	–	HM7	H7C	HM6	HGC	HB9	HB7	HB8	–	–	HM7
Series U Gold alloy contacts Snap switch	-40 to +120 (-40 to +250)	1x SPDT	U2P	UAP	UHC	UAC	UK7	UU7	U2L	UAL	UKP	U2Q	UAQ	UH9	UA9	UK5	UU5	U2S	UAS	UKQ
		1x DPDT	U8P	UDP	UJC	UBC	UD7	UW7	U8L	UDL	UNP	U8Q	UDQ	UJ9	UB9	UD5	UW5	U8S	UDS	UNQ
Series V Inductive Proximity switch	-40 to +100 (-40 to +210)	–	–	–	–	–	–	VFS	VHS	–	–	–	–	–	–	–	–	V5S	VBS	–
Series W Hermetically sealed Silver plated contacts Snap switch	-45 to +230 (-50 to +450)	1x SPDT	W2P	WAP	WHC	WAC	WK7	WU7	W2L	WAL	WKP	W2Q	WAQ	WH9	WA9	WK5	WU5	W2S	WAS	WKQ
		1x DPDT	W8P	WDQ	WJ9	WB9	WD5	WW5	W8S	WDS	WNQ	W8Q	WDQ	WJ9	WB9	WD5	WW5	W8S	WDS	WNQ
Series X Hermetically sealed Gold plated contacts Snap switch	-45 to +230 (-50 to +450)	1x SPDT	X2P	XAP	XHC	XAC	XK7	XU7	X2L	XAL	XKP	X2Q	XAQ	XH9	XA9	XK5	XU5	X2S	XAS	XKQ
		1x DPDT	X8P	XDQ	XJ9	XB9	XD5	XW5	X8S	XDS	XNQ	X8Q	XDQ	XJ9	XB9	XD5	XW5	X8S	XDS	XNQ
Series R High temperature Snap switch	-40 to +400 (-40 to +750)	1x SPDT	R2Q	R1Q	RH9	RA9	RK5	RU5	–	–	RKQ	R2Q	R1Q	RH9	RA9	RK5	RU5	–	–	RKQ
		1x DPDT	R8Q	RDQ	RJ9	RB9	RN5	RF5	–	–	RNQ	R8Q	RDQ	RJ9	RB9	RN5	RF5	–	–	RNQ
Series 8 Hermetically sealed Snap switch	-45 to +400 (-50 to +750)	1x SPDT	82P	8AP	8HC	8AC	8K7	8U7	–	–	8KP	82Q	8AQ	8H9	8A9	8K5	8U5	–	–	8KQ
		1x DPDT	88P	8DP	8JC	8BC	8D7	8W7	–	–	8NP	88Q	8DQ	8J9	8B9	8D5	8W5	–	–	8NQ
Series 9 High temperature Hermetically sealed Snap switch	-45 to +400 (-50 to +750)	1x SPDT	92P	9AP	9HC	9AC	9K7	9U7	–	–	9KP	92Q	9AQ	9H9	9A9	9K5	9U5	–	–	9KQ
		1x DPDT	98P	9DP	9JC	9BC	9D7	9W7	–	–	9NP	98Q	9DQ	9J9	9B9	9D5	9W5	–	–	9NQ
Switch Description	Process ^① Temperature Range °C (°F)	Contacts	Weather proof (IP 65)	ATEX (IP 66)						Weather proof (IP 65)	ATEX (IP 66)									
				II 2G Ex d IIC T6 Gb							II 2G Ex d IIC T6 Gb									
				CS/Aluminium			Cast Iron				CS/Aluminium			Cast Iron						
				3/4" NPT	M20x1,5	3/4" NPT	3/4" NPT	M20x1,5	3/4" NPT		3/4" NPT	M20x1,5	3/4" NPT							
Series R High temperature Snap switch	-40 to +540 ^③ (-40 to +1000)	1x SPDT	R1Y	RK5	RU5	R1Y	RK5	RU5												
		1x DPDT	RDY	RN5	RF5	RDY	RN5	RF5												
Series 9 High temperature Hermetically sealed Snap switch	-40 to +540 ^③ (-40 to +1000)	1x SPDT	9AR	9K7	9U7	9AY	9K5	9U5												
		1x DPDT	9DR	9D7	9W7	9DY	9D5	9W5												

SELECT PNEUMATIC SWITCH MECHANISM & HOUSING

Switch Description	Max supply pressure bar (psi)	Max liquid temperature °C (°F)	Bleed orifice Ø mm (inches)	NEMA 3R (IP 53)	
				T20-A Models	T20-B & T20-D Models
Series J (open air)	6,9 (100)	200 (400)	1,60 (0.063)	JDG	JDE
	4,1 (60)		2,39 (0.094)	JEG	JEE
	4,1 (60)	370 (700)	1,40 (0.055)	JFG	JFE
Series K (closed circuit)	6,9 (100)	200 (400)	–	KOE	KOE
	2,8 (40)		–	KOG	–

① Process temperature based on max. 40 °C (100 °F) ambient temperature and for non steam applications.
 ② On steam applications, temperature down-rated to +200 °C (+400 °F) process at +40 °C (+100 °F) ambient.
 ③ Upon prolonged exposure to temperatures above 425 °C (800 °F), the carbide phase of steel may be converted to graphite. Permissible but not recommended for prolonged use above 425 °C (800 °F). (Applies to models T20-A & T20-B.)

SELECTION DATA T21 DUAL SWITCH

A complete measuring system consists of:

Order code for **T21** models (each unit is factory calibrated to operate on a given specific gravity within the min and the max values listed per model)

1 - 4 | MODEL NUMBER CODE AND MATERIALS OF CONSTRUCTION

Model No.	Set points	Process /Tank connection	Float and trim	Magnetic sleeve
T21-A	2- Tandem float	Carbon steel	316 SST (1.4401)	400 series SST
T21-B				316 SST (1.4401)
T21-D		316 SST (1.4401)		

Important: Actuating level, in either the rising or falling state, and specific gravity must be provided upon placement of order. The maximum available actuating level is governed by the liquid specific gravity and selected float size as given in the table below. The minimum actuating level is 102 mm (4 inches). The minimum distance between the top and bottom actuating levels is 203 mm (8 inches).

FLOAT SELECTION AND MAX ACTUATING LEVEL ^①

Liquid Specific Gravity	Float Size mm (inches)					
	Ø 76 x 127 (3" x 5")		Ø 102 (4")		Ø 114 (4 1/2")	
	Upper	Lower	Upper	Lower	Upper	Lower
1,00	533 (21)	1219 (48)	813 (32)	1219 (48)	1016 (40)	1219 (48)
0,90	229 (9)	762 (30)	457 (18)	1118 (44)	1016 (40)	1219 (48)
0,80	—	—	102 (4)	533 (21)	1016 (40)	1219 (48)
0,70	—	—	—	—	533 (21)	1219 (48)

^① The minimum actuating level is 102 mm (4"). The minimum distance between the top and bottom actuating levels is 203 mm (8").

FLOAT PRESSURE RATINGS

Float Size mm (inches)	Pressure Rating bar (PSIG)			
	40 °C (100 °F)	400 °C (750 °F)	480 °C ^② (900 °F)	540 °C ^② (1000 °F)
Ø 76 x 127 (3" x 5")	34,4 (500)	26,0 (377)	24,3 (353)	23,1 (335)
Ø 102 (4")	41,3 (600)	33,3 (483)	32,0 (465)	31,6 (459)
Ø 114 (4 1/2")	34,4 (500)	27,7 (403)	26,7 (388)	26,4 (383)

^② Upon prolonged exposure to temperatures above 425 °C (800 °F), the carbide phase of steel may be converted to graphite. Permissible but not recommended for prolonged use above 425 °C (800 °F). (Applies to models T20-A & T20-B.)

5 - 7 | TANK CONNECTION AND FLOAT SIZE

Tank Connection	Float sizes		
	Ø 76 x 127 mm (3" x 5")	Ø 102 mm (4")	Ø 114 mm (4 1/2")
ASME Flanges ^③			
4" 150 lbs RF	H3A	—	—
4" 300 lbs RF	H4A	—	—
5" 150 lbs RF	J3A	J3B	J3C ^④
5" 300 lbs RF	J4A	J4B	J4C ^④
6" 150 lbs RF	K3A	K3B	K3C
6" 300 lbs RF	K4A	K4B	K4C
8" 150 lbs RF	L3A	L3B	L3C
EN 1092-1 flanges ^③			
DN 100 PN16, Type B1	8FA	—	—
DN 100 PN 25/40, Type B1	8GA	—	—
DN 150 PN16, Type B1	9FA	9FB	9FC
DN 150 PN 25/40, Type B1	9GA	9GB	9GC

^③ Flanges are threaded onto 1" NPT bushing

^④ Float cannot pass S160 nozzle or greater

9 - 10 | SWITCH MECHANISM & HOUSING (next page)

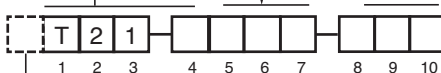

complete order code for T21 models

X = product with a specific customer requirement

SELECT ELECTRIC SWITCH MECHANISM & HOUSING

Switch Description	Process Temperature Range °C (°F)	Contacts	T21-A Models									T21-B and T21-D Models								
			Weather proof (IP 66)	ATEX - IECEx (IP 66)						FM (IP 66) NEMA 7/9	Weather proof (IP 66)	ATEX - IECEx (IP 66)						FM (IP 66) NEMA 7/9		
				II 2G Ex d IIC T6 Gb			II 1G Ex ia IIC T6 Ga					II 2G Ex d IIC T6 Gb			II 1G Ex ia IIC T6 Ga					
				Cast Aluminium		Cast Iron (ATEX only)	Cast Aluminium		Cast Alu.			Cast Aluminium		Cast Iron (ATEX only)	Cast Aluminium		Cast Alu.			
M20x1,5	1" NPT	M20x1,5	1" NPT	M20x1,5	3/4" NPT	M20x1,5	1" NPT	1" NPT	M20x1,5	1" NPT	M20x1,5	1" NPT	M20x1,5	3/4" NPT	M20x1,5	1" NPT	1" NPT			
Series B Snap switch	-40 to +120 (-40 to +250)	2x SPDT	B4A	BBA	BLC	BDC	BL7	BV7	-	-	BLA	B4B	BBB	BL9	BD9	BL5	BV5	-	-	BLB
		2x DPDT	B1A	BEA	BPC	BGC	BO7	BY7	-	-	BOA	B1B	BEB	BP9	BG9	BO5	BY5	-	-	BOB
Series C Snap switch	-40 to +230 (-40 to +450)	2x SPDT	C4A	CBA	CLC	CDC	CL7	CV7	C4X	CBX	CLA	C4B	CBB	CL9	CD9	CL5	CV5	C4T	CBT	CLB
		2x DPDT	C1A	CEA	CPC	CGC	CO7	CY7	C1X	CEX	COA	C1B	CEB	CP9	CG9	CO5	CY5	C1T	CET	COB
Series D DC Current Snap switch	-40 to +120 (-40 to +250)	2x SPDT	D4B	DBB	DL9	DD9	DL5	DV5	-	-	DLB	D4B	DBB	DL9	DD9	DL5	DV5	-	-	DLB
		2x DPDT	D1B	DEB	DP9	DG9	DO5	DY5	-	-	DOB	D1B	DEB	DP9	DG9	DO5	DY5	-	-	DOB
Series F Hermetically sealed Snap switch	-45 to +400 (-50 to +750)	2x SPDT	FFA	FBA	FLC	FDC	FL7	FV7	-	-	FLA	FFB	FBB	FL9	FD9	FL5	FV5	-	-	FLB
		2x DPDT	FHA	FEA	FPC	FGC	FO7	FY7	-	-	FOA	FHB	FEB	FP9	FG9	FO5	FY5	-	-	FOB
Series U Gold alloy contacts Snap switch	-40 to +120 (-40 to +250)	2x SPDT	U4A	UBA	ULC	UDC	UL7	UV7	U4X	UBX	ULA	U4B	UBB	UL9	UD9	UL5	UV5	U4T	UBT	ULB
		2x DPDT	U1A	UEA	UPC	UGC	UO7	UY7	U1X	UEX	UOA	U1B	UEB	UP9	UG9	UO5	UY5	U1T	UET	UOB
Series W Hermetically sealed Silver plated contacts Snap switch	-45 to +230 (-50 to +450)	2x SPDT	W4A	WBA	WLC	WDC	WL7	WV7	W4X	WBX	WLA	W4B	WBB	WL9	WD9	WL5	WV5	W4T	WBT	WLB
		2x DPDT	W1B	WEB	WP9	WG9	WO5	WY5	W1T	WET	WOB	W1B	WEB	WP9	WG9	WO5	WY5	W1T	WET	WOB
Series X Hermetically sealed Gold plated contacts Snap switch	-45 to +230 (-50 to +450)	2x SPDT	X4A	XBA	XLC	XDC	XL7	XV7	X4X	XBX	XLA	X4B	XBB	XL9	XD9	XL5	XV5	X4T	XBT	XLB
		2x DPDT	X1B	XEB	XP9	XG9	XO5	XY5	X1T	XET	XOB	X1B	XEB	XP9	XG9	XO5	XY5	X1T	XET	XOB
Series R High temperature Snap switch	-40 to +400 (-40 to +750)	2x SPDT	R4B	R3B	RL9	RD9	RL5	RV5	-	-	RLB	R4B	R3B	RL9	RD9	RL5	RV5	-	-	RLB
		2x DPDT	RHB	REB	RP9	RG9	RO5	RG5	-	-	ROB	RHB	REB	RP9	RG9	RO5	RG5	-	-	ROB
Series 8 Hermetically sealed Snap switch	-45 to +400 (-50 to +750)	2x SPDT	84A	8BA	8LC	8DC	8L7	8V7	-	-	8LA	84B	8BB	8L9	8D9	8L5	8V5	-	-	8LB
		2x DPDT	81A	8EA	8PC	8GC	8O7	8Y7	-	-	8OA	81B	8EB	8P9	8G9	8O5	8Y5	-	-	8OB
Series 9 High temperature Hermetically sealed Snap switch	-45 to +400 (-50 to +750)	2x SPDT	94A	9BA	9LC	9DC	9L7	9V7	-	-	9LA	94B	9BB	9L9	9D9	9L5	9V5	-	-	9LB
		2x DPDT	91A	9EA	9PC	9GC	9O7	9Y7	-	-	9OA	91B	9EB	9P9	9G9	9O5	9Y5	-	-	9OB
Switch Description	Process Temperature Range °C (°F)	Contacts	Weather proof (IP 65)	ATEX (IP 66)			Weather proof (IP 65)	ATEX (IP 66)												
				II 2G Ex d IIC T6 Gb						II 2G Ex d IIC T6 Gb										
				CS/Aluminium				Cast Iron			CS/Aluminium			Cast Iron						
				3/4" NPT				M20x1,5			3/4" NPT			M20x1,5			3/4" NPT			
Series R High temperature Snap switch	-40 to +540 ^② (-40 to +1000)	2x SPDT	R3M			RL5			RV5			R3M			RL5			RV5		
		2x DPDT	REM			RO5			RG5			REM			RO5			RG5		
Series 9 High temperature Hermetically sealed Snap switch	-40 to +540 ^② (-40 to +1000)	2x SPDT	9BD			9L7			9V7			9BM			9L5			9V5		
		2x DPDT	9ED			9O7			9Y7			9EM			9O5			9Y5		

① Process temperature based on max. 40 °C (100 °F) ambient temperature and for non steam applications.

② Upon prolonged exposure to temperatures above 425 °C (800 °F), the carbide phase of steel may be converted to graphite. Permissible but not recommended for prolonged use above 425 °C (800 °F). (Applies to models T20-A & T20-B.)

PHYSICAL SPECIFICATIONS

Description		Specification
Measured variable		Liquid level / interface level
Physical range		Standard models: min S.G. 0,60 (T20) – 0,70 (T21)
Process temperature Process pressure (for higher ratings consult factory)	ø 76 x 127 mm (3" x 5") float	Up to 34,5 bar (500 psi) @ 40 °C (100 °F) Up to 540 °C (1000 °F) @ 23,1 bar (335 psi)
	ø 89 x 152 mm (3 1/2" x 6") float	Up to 34,5 bar (500 psi) @ 40 °C (100 °F) Up to 540 °C (1000 °F) @ 26,4 bar (383 psi)
	ø 102 mm (4") float	Up to 41,3 bar (600 psi) @ 40 °C (100 °F) Up to 540 °C (1000 °F) @ 31,6 bar (459 psi)
	ø 114 mm (4 1/2") float	Up to 34,5 bar (500 psi) @ 40 °C (100 °F) Up to 540 °C (1000 °F) @ 26,4 bar (383 psi)
Process connection material		carbon steel or stainless steel (others at request)
Wetted materials	Float and trim	316 SST (1.4401)
	Magnetic sleeve	316 SST (1.4401) or 400 series SST

ELECTRICAL SPECIFICATIONS

Description	Specification
Switch ratings	Up to 15 A @ 240 V AC (depending on switch mechanism) Up to 10 A @ 120 V DC (depending on switch mechanism)
Signal output	Single or dual SPDT or DPDT contacts or single pneumatic
Switch types (see page 4)	Dry contact with standard or gold alloy contacts, Hermetically sealed, Hermetically sealed with gold or silver plated contacts, Proximity switch, or single pneumatic bleed and non bleed

ELECTRICAL CONNECTION

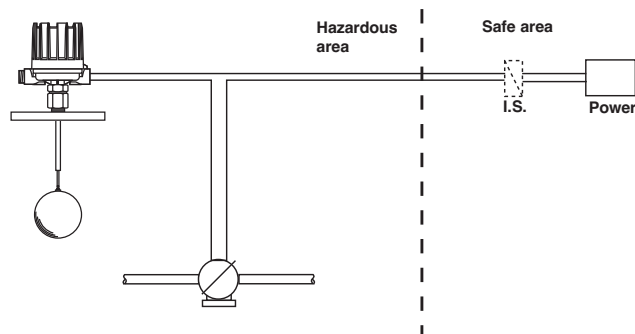
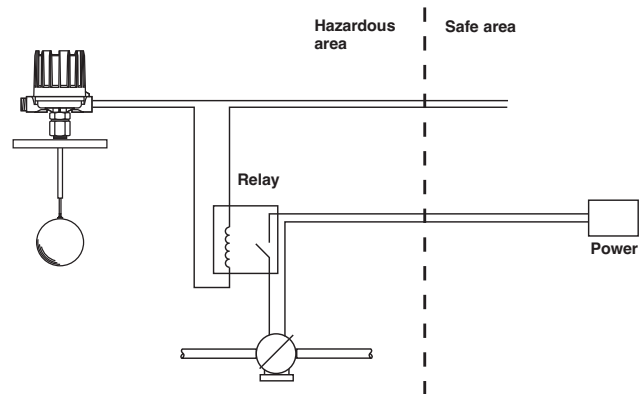



QUALITY ASSURANCE - ISO 9001

THE QUALITY ASSURANCE SYSTEM IN PLACE AT MAGNETROL GUARANTEES THE HIGHEST LEVEL OF QUALITY DURING THE DESIGN, THE CONSTRUCTION AND THE SERVICE OF CONTROLS. OUR QUALITY ASSURANCE SYSTEM IS APPROVED AND CERTIFIED TO **ISO 9001** AND OUR TOTAL COMPANY IS COMMITTED TO PROVIDING FULL CUSTOMER SATISFACTION BOTH IN QUALITY PRODUCTS AND QUALITY SERVICE.

PRODUCT WARRANTY

ALL MAGNETROL MECHANICAL LEVEL CONTROLS ARE WARRANTED FREE OF DEFECTS IN MATERIALS AND WORKMANSHIP FOR 3 FULL YEARS FROM THE DATE OF ORIGINAL FACTORY SHIPMENT.

IF RETURNED WITHIN THE WARRANTY PERIOD; AND, UPON FACTORY INSPECTION OF THE CONTROL, THE CAUSE OF THE CLAIM IS DETERMINED TO BE COVERED UNDER THE WARRANTY; THEN, MAGNETROL INTERNATIONAL WILL REPAIR OR REPLACE THE CONTROL AT NO COST TO THE PURCHASER (OR OWNER) OTHER THAN TRANSPORTATION.

MAGNETROL SHALL NOT BE LIABLE FOR MISAPPLICATION, LABOR CLAIMS, DIRECT OR CONSEQUENTIAL DAMAGE OR EXPENSE ARISING FROM THE INSTALLATION OR USE OF THE EQUIPMENT. THERE ARE NO OTHER WARRANTIES EXPRESSED OR IMPLIED, EXCEPT, SPECIAL WRITTEN WARRANTIES COVERING SOME MAGNETROL PRODUCTS.

BULLETIN: BE 44-117.9
EFFECTIVE: JULY 2021
SUPERSEDES: April 2018

UNDER RESERVE OF MODIFICATIONS



MAGNETROL®

AMETEK®
SENSORS, TEST & CALIBRATION