



HENNLICH

MERES

ZUBOVÝ PRŮTOKOMĚR LABO-VHZ-I/U/F/C

Flow Transmitter LABO-VHZ-I / U / F / C



- Volumetric flow measurement
- Almost no effect from differing viscosities
- 0..10 V, 4..20 mA, frequency/pulse output, completely configurable
- Robust construction
- Compact design

Characteristics

The VHZ gearwheel flow meter measures the flow by a volumetric principle, in which a pair of gearwheels is moved proportional to the flow rate. The movement of the gearwheels is measured through the enclosing housing wall by a sensor. The devices are suitable for viscous, fluid, self-lubricating media, as well as for aqueous fluids such as soaps, pasts, emulsions etc. which have a non-abrasive character. Because of the volumetric functioning principle, the devices are almost completely independent of viscosity.

The LABO electronics make various output signals available:

- Analog signal 0/4..20 mA (LABO-VHZ-...I)
- Analog signal 0/2..10 V (LABO-VHZ-...U)
- Frequency signal (LABO-VHZ-...F) or
- A value signal Pulse / x Litres (LABO-VHZ-...C)

A model with switching output is also available.

If desired, the range end value can be set to the currently existing flow using "teaching".

Technical data

Sensor	gearwheel volumeter	
Nominal width	DN 8..25	
Process connection	female thread G 1/4..G 1	
Metering ranges	0.02..150 l/min for details, see table "Ranges"	
Measurement accuracy	±3 % of the measured value in the specified metering range (measured at 20 mm ² /s)	
Repeatability	±0.3 %	
Medium temperature	-25..+80 °C optionally -25..+120 °C	
Ambient temperature	-20..+70 °C	
Pressure resistance	see table "Pressure resistance and weight"	
Pressure loss	see upstream page "Function and benefits - volumetric, gearwheel"	
Materials medium-contact	see table "Materials"	
Materials, non-medium-contact	Sensor tube	CW614N nickelled
	Adhesive	Epoxy resin
	Flange bolts	stainless steel
Supply voltage	10..30 V DC at voltage output 10 V: 15..30 V DC	
Power consumption	< 1 W (for no-load outputs)	
Output data:	all outputs are resistant to short circuits and reversal polarity protected	
Current output:	4..20 mA (0..20 mA available on request)	
Voltage output:	0..10 V (2..10 V available on request) output current max. 20 mA	
Frequency output:	transistor output "push-pull"	
Pulse output:	I _{out} = 100 mA max. transistor output "push-pull" I _{out} = 100 mA max. pulse width 50 ms pulse per volume is to be stated	
Display	yellow LED indicates operating voltage (LABO-VHZ-I / U) or output status (LABO-VHZ-F / C) (rapid flashing = Programming)	
Electrical connection	for round plug connector M12x1, 4-pole	
Ingress protection	IP 67	
Weight	see table "Connection, pressure resistance, and weight"	
Conformity	CE	

ZUBOVÝ PRŮTOKOMĚŘ LABO-VHZ-I/U/F/C



HENNLICH

MERES

Signal output curves

Value x = Begin of the specified range

= not specified range

Current output

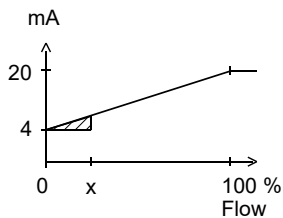

Voltage output

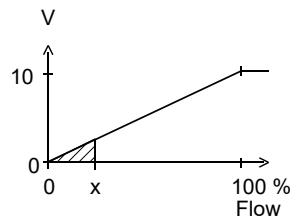

Frequency output

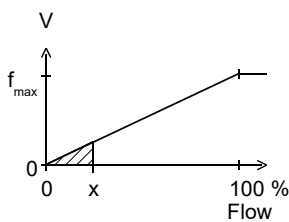

f_{max} selectable in the range of up to 2000 Hz

Other characters on request.

Pressure resistance and weight

G	Types	PN bar	Housing material	Weight kg
G 1/4	LABO-VHZ-008GA	200	Aluminium	0.5
G 1/4	LABO-VHZ-008GK	160	Stainless steel	1.5
G 3/8	LABO-VHZ-010GA	160	Aluminium	0.5
G 3/8	LABO-VHZ-010GK	160	Stainless steel	1.5
G 3/4	LABO-VHZ-020GA	160	Aluminium	1.6
G 3/4	LABO-VHZO-020GA	100	Aluminium / glass	1.6
G 1	LABO-VHZ-025GA	80	Aluminium	6.3

Ranges

Metering range l/min	Types	Pulse volume (= resolution) cm ³
0.02.. 2	LABO-VHZ-008	0.04
0.10.. 6	LABO-VHZ-010	0.20
0.50.. 50	LABO-VHZ(O)-020	2.00
3.00.. 150	LABO-VHZ-025	5.22

Materials

	LABO-VHZ-008..025GA	LABO-VHZ-008GK	LABO-VHZ-010..025GK
Housing	Al anodised	stainless steel 1.4404	stainless steel 1.4404
gear-wheel and Axis	stainless steel 1.4462	stainless steel 1.4462	stainless steel 1.4462
Bearing	iglidur X	stainless steel 1.4037 / 1.4016 /PVD-coated	iglidur X
Seal	FKM	FKM	FKM
Sight glass	glass (only with VHZO)		

Wiring

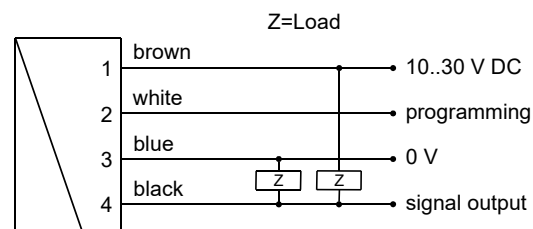

Connection example: PNP NPN

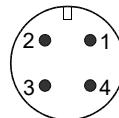

Before the electrical installation, it must be ensured that the supply voltage corresponds to the data sheet.

It is recommended to use shielded wiring.

The push-pull output) of the frequency or pulse output version can as desired be switched as a PNP or an NPN output.



HENNLICH

MERES

ZUBOVÝ PRŮTOKOMĚŘ LABO-VHZ-I/U/F/C

Dimensions

LABO-VHZ-008

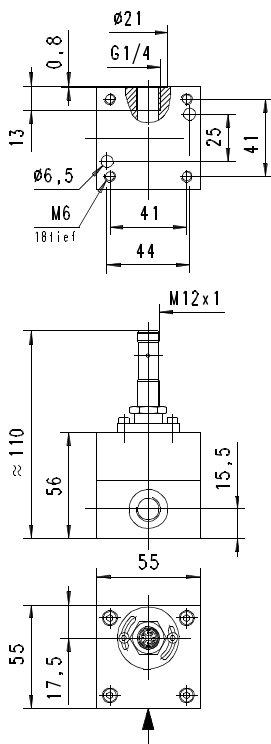

LABO-VHZ-020

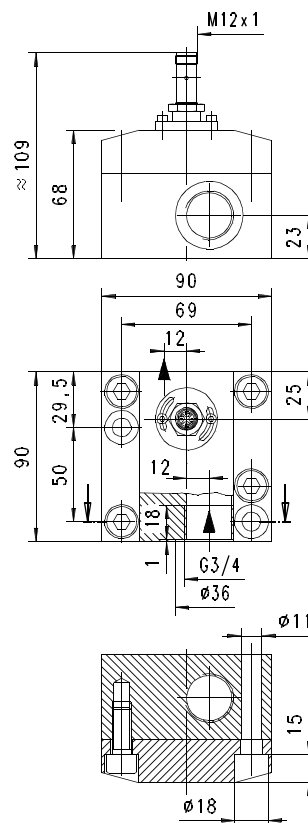

LABO-VHZ-010

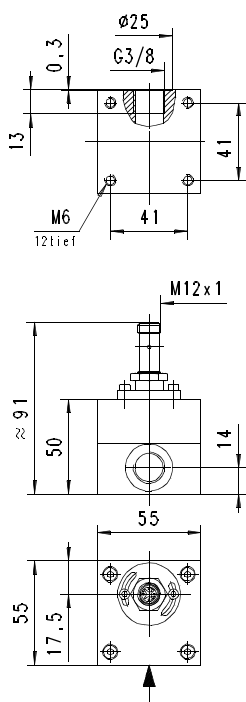

LABO-VHZ-025

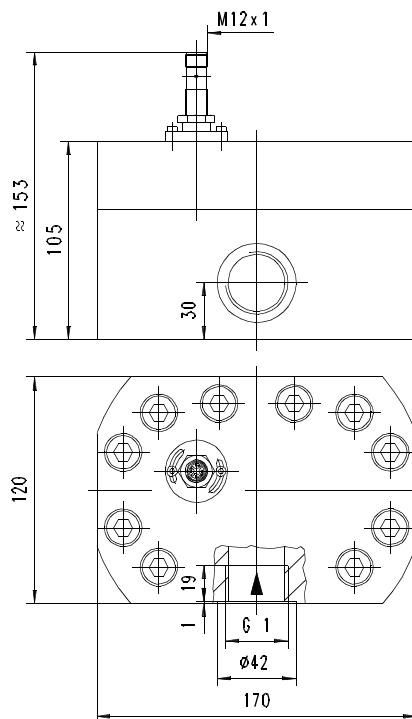

ZUBOVÝ PRŮTOKOMĚR LABO-VHZ-I/U/F/C



HENNLICH

MERES

Handling and operation

Installation

The VHZ flow measurement device can be installed anywhere in the pipework system. A run-in section is not required. The direction of flow may be freely chosen.

It should be ensured that no dirt particles (thread cutting swarf) can get into the flow space, as this could cause the blockage of the gearwheels. It may therefore be necessary to install filters upstream of the flow measurement device (mesh size 30 µm).

Note

The metering range end value can be programmed by the user via "teaching". Requirement for programmability must be stated when ordering, otherwise the device cannot be programmed. The ECI-1 device configurator with associated software is available as a convenient option for programming all parameters by PC, and for adjustment.

The teaching option is not available for the pulse output version.

Operation and programming

The teaching process can be carried out by the user as follows:

- The flow rate to be set is applied to the device.
- Apply an impulse of at least 0.5 seconds and max. 2 seconds duration to pin 2 (e.g. via a bridge to the supply voltage or a pulse from the PLC), in order to accept the measured value.
- When the teaching is complete, pin 2 should be connected to 0 V, so as to prevent unintended programming.

The devices have a yellow LED which flashes during the programming pulse. During operation, the LED serves as an indicator of operating voltage (for analog output) or of switching status (for frequency or pulse output).

In order to avoid the need to transit to an undesired operating status during the teach-in, the device can be provided ex-works with a teach-offset. The teach-offset point is added to the currently measured value before saving. The offset point can be positive or negative.

Example: The end of the metering range should be set to 80 %. However, only 60 % can be achieved without problem. In this case, the device would be ordered with a "teach-offset" of +20 %.. At a flow rate of 60 % in the process, teaching would then store a value of 80 %.

There are many more parameters which can be programmed by the ECI-1 device configurator if necessary.

Ordering code

The base device is ordered, e.g. VHZ-008GA002E with electronics, e.g. OMNI-VHZ-008IPLO

1. 2. 3. 4. 5. 6.
VHZ- G E

7. 8. 9. 10. 11.
LABO-VHZ- S

○=Option

1. Sight glass										
-	no sight glass									
O-	with sight glass									
2. Nominal width										
008	DN 8 - G 1/4									•
010	DN 10 - G 3/8									•
020	DN 20 - G 3/4									•
025	DN 25 - G 1									•
3. Process connection										
G	female thread									
4. Body material										
A	aluminium									•
K	<input type="checkbox"/> stainless steel									•
5. Ranges										
002	0.02.. 2 l/min									•
006	0.10.. 6 l/min									•
050	0.50.. 50 l/min									•
150	3.00..150 l/min									•
6. Connection for										
E	electronics									•
7. For base device										
008	VHZ-008G..E									•
010	VHZ-010G..E									•
020	VHZ(O)-020G..E									•
025	VHZ-025G..E									•
8. Signal output										
I	current output 4..20 mA									
U	voltage output 0..10 V									
F	frequency output									
C	pulse output									
9. Programming										
N	cannot be programmed (no teaching)									
P	<input type="checkbox"/> programmable (teaching possible)									
10. Electrical connection										
S	for round plug connector M12x1, 4-pole									
11. Option										
H	<input type="checkbox"/> medium temperature max. 120 °C (with 300 mm cable)									



ZUBOVÝ PRŮTOKOMĚR LABO-VHZ-I/U/F/C

Required ordering information

For LABO-VHZ-...F:

Output frequency at full scale

 Hz

Maximum value: 2.000 Hz

For LABO-VHZ-...C:

The volume must be specified for the pulse output version (with numerical value and unit) which will correspond to one pulse.

Volume per pulse (numerical value)

Volume per pulse (unit)

Options

Special range for analog output:

<= metering range (standard=metering range)

 l/min

Special range for frequency output:

<= metering range (standard=metering range)

 l/min

Power-On delay period (0..99 s)

(time after applying power during which the outputs are not activated or set to defined values)

 s

Further options available on request.

Accessories

- Cable/round plug connector (KB...) see additional information "Accessories"
- Evaluation electronics OMNI-TA
- Device configurator ECI-1