

ENGINEERING
YOUR SPRAY SOLUTION



➤➤ AIR QUALITY CONTROL SYSTEMS

for cement plants

AIR QUALITY CONTROL SYSTEMS

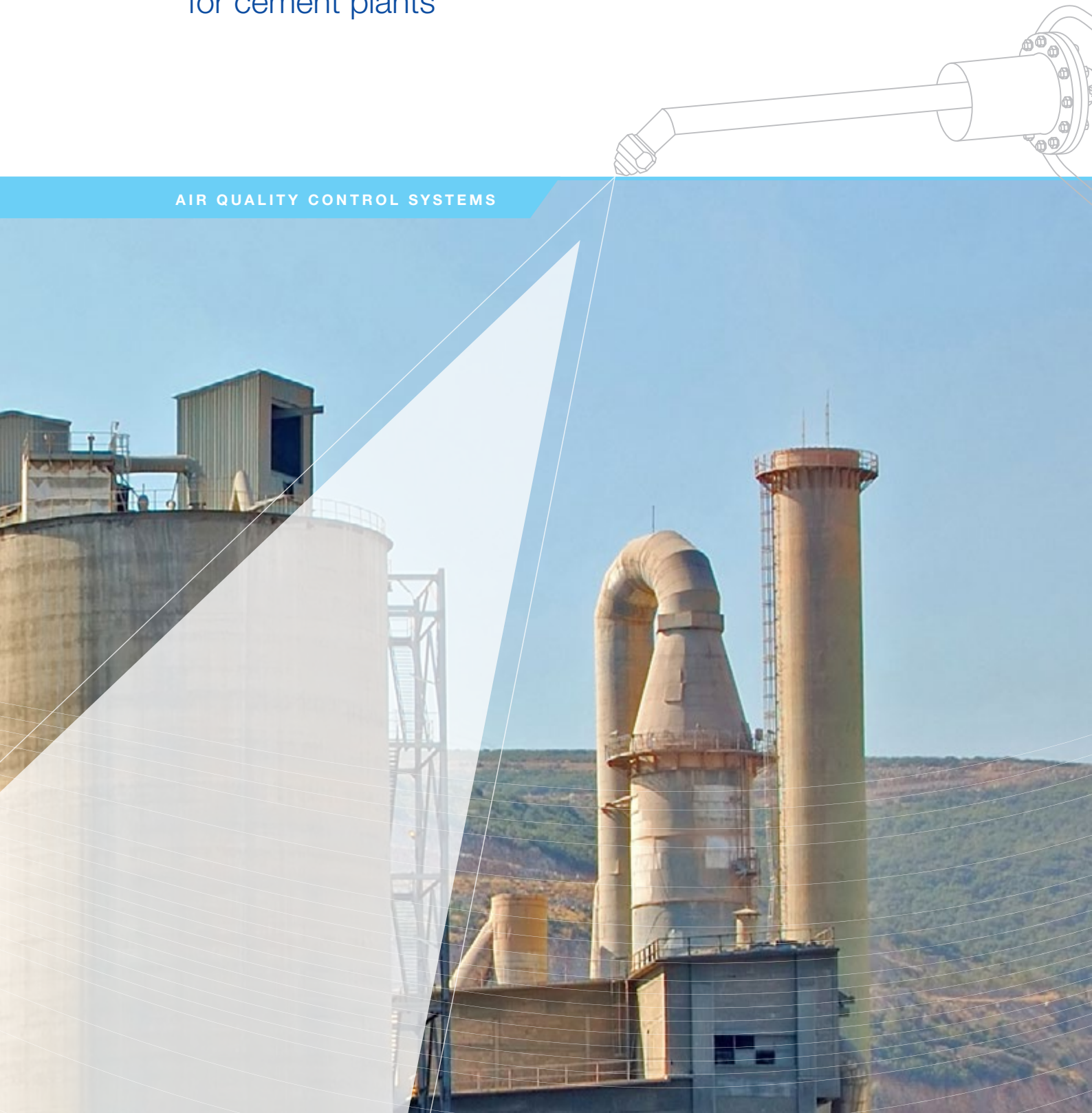

EFFICIENT COOLING AND CONDITIONING WITH LECHLER NOZZLE LANCES AND SYSTEMS

Lechler is Europe's No. 1 and is also one of the leading suppliers of nozzles and systems worldwide. For over 140 years, we have pioneered numerous groundbreaking developments in the field of nozzle technology. We combine comprehensive nozzle engineering expertise with a deep understanding of application-specific requirements to create products that offer outstanding performance and reliability.



Innovative solutions for a trending market

The cement industry has been undergoing significant changes for many years now. On the one hand, we are seeing massive concentrations and a trend towards ever bigger plants. On the other hand, strict emission requirements are creating a constant pressure to invest and innovate.

Efficient gas conditioning offers a wide range of approaches to reduce costs and increase efficiency. A prerequisite is that the respective processes are thoroughly understood and that the gas conditioning is adapted accordingly.

The right solution for every requirement

With our wide range of nozzles and gas conditioning systems, we offer the perfect solution for every application. Every cement plant naturally comes with its own set of challenges.

We rise to these challenges and work with you to develop the best solutions for your business. We support you with comprehensive consulting services ranging from process analysis to turnkey solutions.

1879

Company founded by Paul Lechler

1893

Patent for liquid atomization

1967

Relocation of production to Metzingen

1978

Expansion to the USA and then to other countries

1995

Production, sales and administration are concentrated in Metzingen

COMPETENCE – THE ADVANTAGE OF MULTIPLE PERSPECTIVES

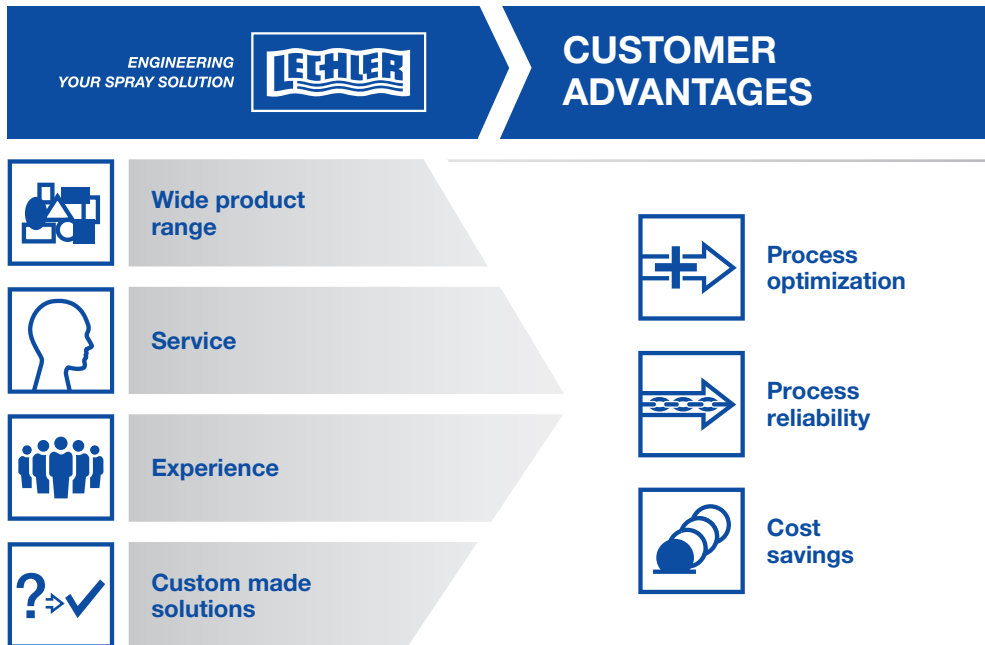

For many years now, nozzles, spray systems for industrial gas conditioning have been an integral part of our Environmental Technologies portfolio. An international team of outstanding engineers and process engineers continuously develop new solutions and adapt them to new challenges.

Through the use of global databases and close cooperation with external specialized institutes and renowned plant manufacturers, we have built up an interdisciplinary knowledge base – and with it optimal process integration.

Our constant exchange of experiences with operators of cement plants means we are always in tune with the latest developments and can react proactively to them.

To provide you with local support, we are represented all around the globe – with locations in the USA, Great Britain, India, China, ASEAN, France, Belgium, Italy, Finland, Hungary, Spain and Sweden, as well as sales partners in almost every country.

Costs under control

In the production of cement in particular, extreme environmental conditions prevail. We manufacture our nozzles from highly resistant materials with minimal wear.

The long service life of our high-quality components for valve skid units and systems does not just reduce the pure costs of spare parts, but also decreases downtimes and maintenance costs. In addition, customer-specific systems lower the operating costs to a minimum.

CONTENTS	Page
Applications	4–5
Gas cooling applications	
Evaporative and bypass cooler	6–7
Downcomer duct	8
Cyclone preheater	9
Clinker cooler	10
Ball and roller mill	11
Choosing the right nozzle	
Spillback nozzles	13
VarioJet nozzles	14
Laval nozzles	15
Nozzle lances	16–17
VarioCool	18–21
Gas conditioning applications	
Denitrification (DeNOx)	22–25
Special twin-fluid nozzles for DeNOx applications	26–27
VarioClean – NOx	28
VarioClean – heSNCR	29–30
CFD	31
Engineering and service	32–33
Measuring technology	34–36
Quality with a system	36

Twin-fluid nozzles allow for an application-optimized fine droplet spectrum, whereas spillback systems do away with compressed air altogether to reduce the energy consumption.

Our job is to identify the appropriate solution in each case and then adapt it perfectly to the on-site conditions.

140

1879 - 2019

- 2010**
Expansion of production with a new 13.000 m² Manufacturing Plant
- 2016**
New Development and Technology Center is opened in Metzingen
- 2019**
Celebrating 140 years
- 2021**
New factory in China
- 2022**
New logistics center in Metzingen

AN OVERVIEW OF LECHLER APPLICATIONS

Gas cooling tower (GCT)

Precise cooling and conditioning of hot flue gases creates stable outlet conditions for the safe and efficient operation of downstream plant components.

Downcomer duct

Pre-cooling to protect downstream plant components and reduce the amount of operating gas.

Roller mill

Injection of water to stabilize the grinding bed and to optimize the grinding process.

Ball mill

Injected water lowers the temperature in the mill.

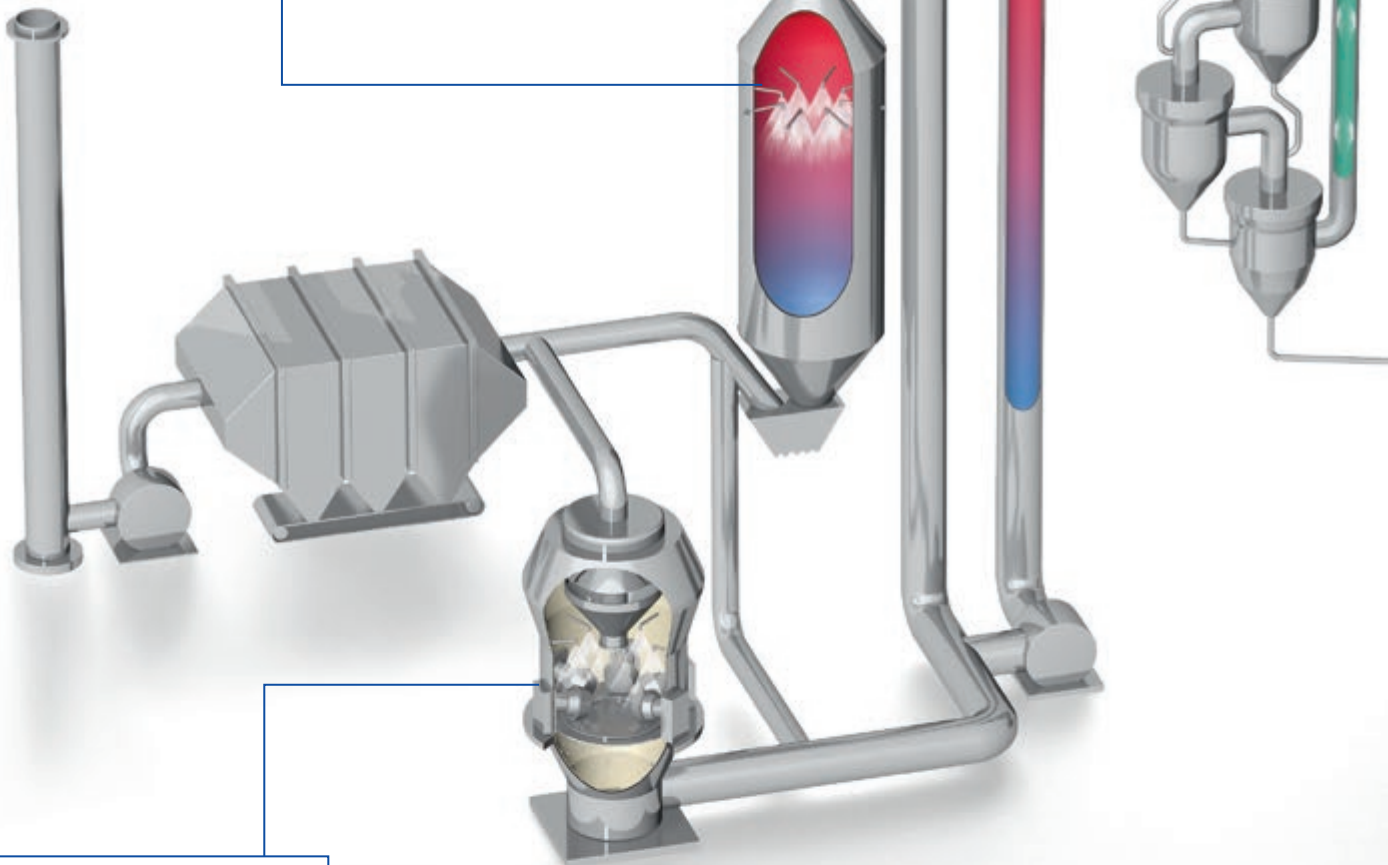

Cyclone preheater

Injection for compensation of temperature peaks or additional cooling before the downcomer duct.

Calciner

SNCR process for the reduction of nitrogen oxides and compliance with the legal limit values through powerful denitrification systems in various configurations.

Chlorine bypass

Cooling of partial gas flow for the safe and efficient operation of the downstream plant components.

Clinker cooler

Gas cooling in or after the clinker cooler to optimize, protect and improve the efficiency of the downstream plant components.

Long kiln

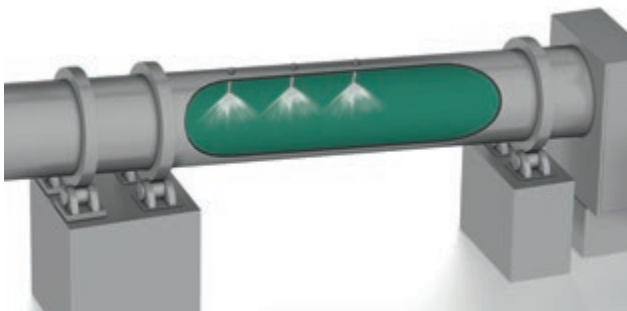

Controllable and multi-stage injection to ensure precise SNCR denitrification for plants with optimal temperature range in the rotating kiln.



GAS COOLING APPLICATIONS EVAPORATIVE AND BYPASS COOLER

Application

Hot exhaust gases can damage fabric and electric filters or at least reduce the service life. The resulting costs and maintenance downtimes can be prevented by a reliable and controlled cooling of the exhaust gases in the gas cooling tower and chlorine bypass cooler. The simultaneous reduction of the operating volume of exhaust gases has a positive effect on the investment and operating costs of the downstream plant components.

In addition, the separation efficiency of electrical and fabric filters is improved.

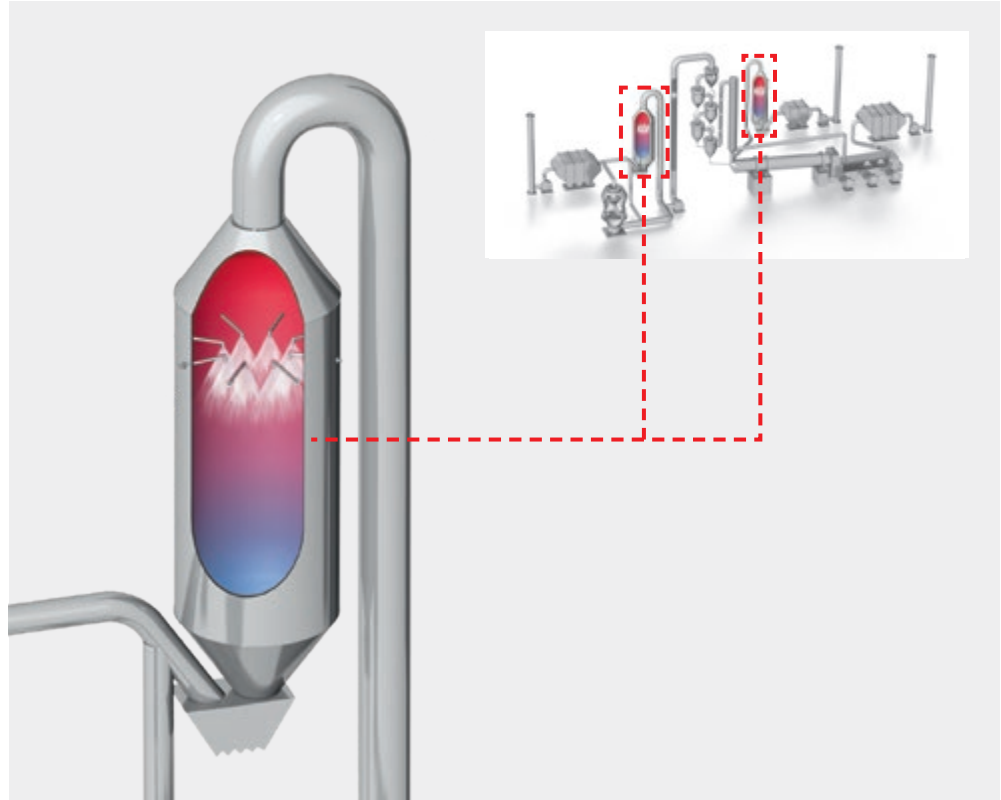

Our solution

For safe cooler operation and short evaporation distances, homogeneous and swirl-free gas distribution over the entire duct cross-section is required. Using fixtures (perforated plates, flow straighteners etc.) in the gas inlet, the gas distribution can be optimized in a targeted manner. We gladly support our customers in the design of these fixtures with detailed

CFD simulations so as to ensure an optimal and holistic solution.

The outlet temperature and the required distance for the evaporation of the water are controlled via the amount of water injected and the droplet size. Complete evaporation is essential to prevent material build-up and damp material in the discharge and to ensure

reliability of operation and plant availability.

In order to obtain an optimal and comprehensive design of the cooler and of the associated injection system, a large number of interacting variables and different operating conditions therefore need to be taken into account. Thanks to our many years of experience, we are able to

assist you in calculating the amount of water and dimensioning the evaporation distance.

For implementation, we offer both twin-fluid or spillback systems. We configure your system in line with the process data and the cooler size, thus giving you an optimum solution.

At a glance

Typical operating values

- Inlet temperature: 250–500 °C
- Outlet temperature: 120–300 °C

Objectives

- Protection of downstream plant components (e.g. hose filter)
- Higher separation efficiency of electric filters
- Reduced operating gas volumes → lower investment and operating costs
- Process optimization
- Hg separation
- Prevention of material build-up
- Prevention of corrosion at dew-point temperature

Advantages compared to false air and heat exchangers

- Large turn-down ratio
- Short response times
- Retrofitting in existing plants
- Low investment costs
- Positive process effects (e.g. higher dust moisture leading to improved separation in the electric static filter)
- No clogging of the heat exchanger
- No increase of the operating gas quantity





GAS COOLING APPLICATIONS DOWNCOMER DUCT

Application

As an alternative or addition to the gas cooling tower, the gas can also be cooled down after the preheating tower in the downcomer duct. This option is often used in new plants and plants with a long and straight duct.

In the case of existing plants, injection into the downcomer duct is performed to optimize the process (e.g. to increase production or when using alternative fuels). In this way, temperature peaks can be compensated and where necessary, subsequent cooling in the gas cooling tower supported. Due to the associated reduction in the operating gas flow rate, there is an energy savings potential at the downstream fan.

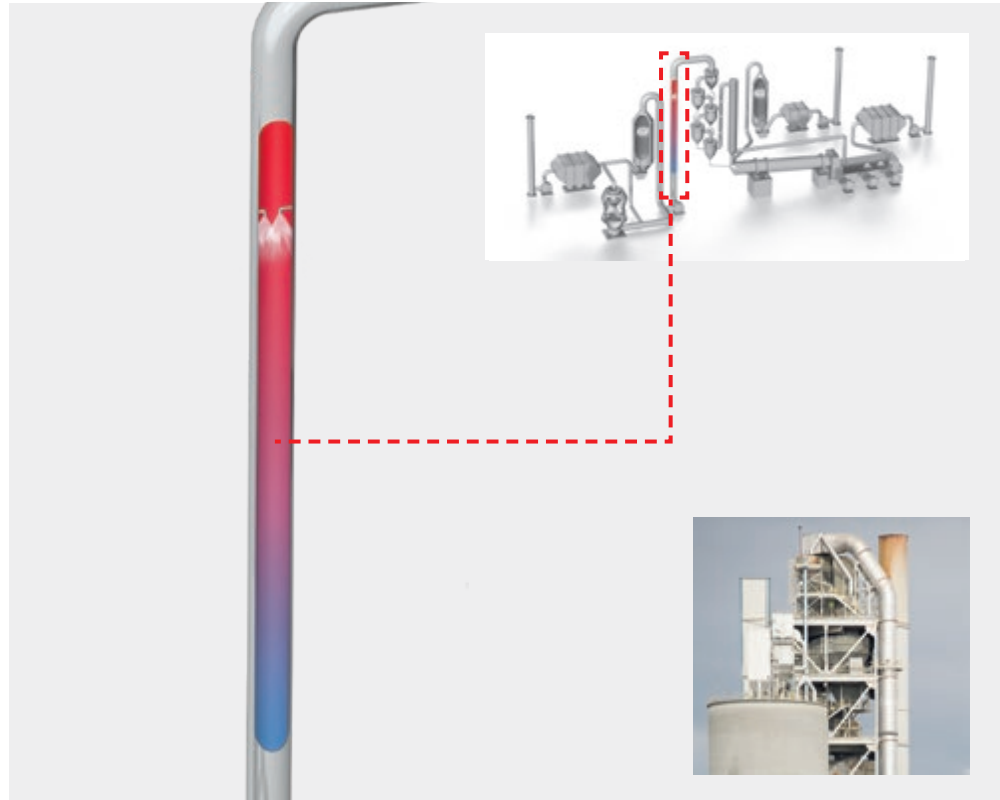

Our solution

Generally speaking, similar factors need to be taken into account here as with the gas cooling tower. Owing to the smaller cross-sections and the higher velocity that results, the evaporation time is reduced compared to the GCT. The required outlet temperature and the available evaporation distance determine the amount of water required and the droplet size necessary for complete evaporation.

Complete evaporation is required to prevent material build-up and to ensure the durability of the downstream fan. Due to the higher gas velocity and the resulting decrease in evaporation time, finer droplets are required. This is why almost exclusively twin-fluid systems are used. In order to provide the perfect solution, we configure the systems according to the process data and duct dimensions of our customers.

At a glance

Typical operating values

- Inlet temperature: 250–500 °C
- Outlet temperature: 150–300 °C

Objectives

- Replacement of a gas cooling tower
 - Protection of downstream plant components
 - Higher separation efficiency of electric filters
 - Reduced operating gas volumes → lower investment and operating costs
 - Process optimization
- Addition of a gas cooling tower
 - Relieving the cooler and induced draft system while increasing production
 - Prevention of caking on the fan where appropriate
 - Prevention of material build-up

Advantages compared to gas cooling towers

- Smaller fan → lower investment and operating costs
- No dust discharge devices



GAS COOLING APPLICATIONS CYCLONE PREHEATER

Application

Additional cooling through injection into the top cyclone of the preheater gives you various advantages. On the one hand, it supports subsequent cooling in the duct or GCT, while temperature peaks can be compensated on the other.

The associated temperature reduction decreases the operating gas flow rate. This reduces the energy required by the downstream fan, which may also eliminate the need to exchange it. In addition, the efficiency of the cyclone is increased through the moistening of the raw material.

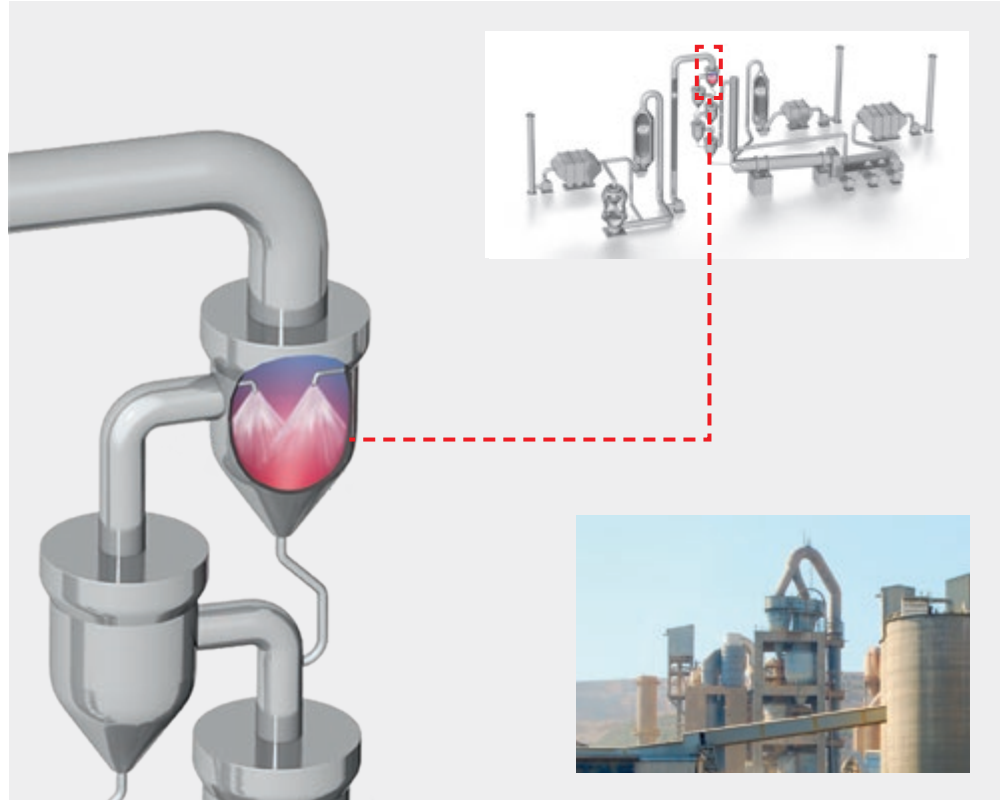

Our solution

Direct injection into the top cyclone is an effective way of eliminating temperature peaks. The high dust load and the resulting large surface area facilitate evaporation.

To enable a controlled water quantity to be introduced, we mostly use spillback systems.

At a glance

Typical operating values

- Inlet temperature: 300–400 °C
- Outlet temperature: 260–320 °C

Objectives

- Alternative in case no cooling is possible in the duct
- Supporting of the subsequent cooling
- Reduction of the gas flow rate
- Protection against overtemperature in downstream plant components

Side effects

- Reduced heat recovery in the top cyclone
- Increase of production output



GAS COOLING APPLICATIONS CLINKER COOLER

Application

Following capacity increases, cooling with air alone is often no longer sufficient to achieve the proper operating conditions of the downstream filter. Injecting water into the clinker cooler provides a remedy here. The cooling of the gas also causes the gas volume to reduce and protects downstream plant components from excessive gas temperatures. This reduces operating costs and avoids additional investment costs for a larger filter.

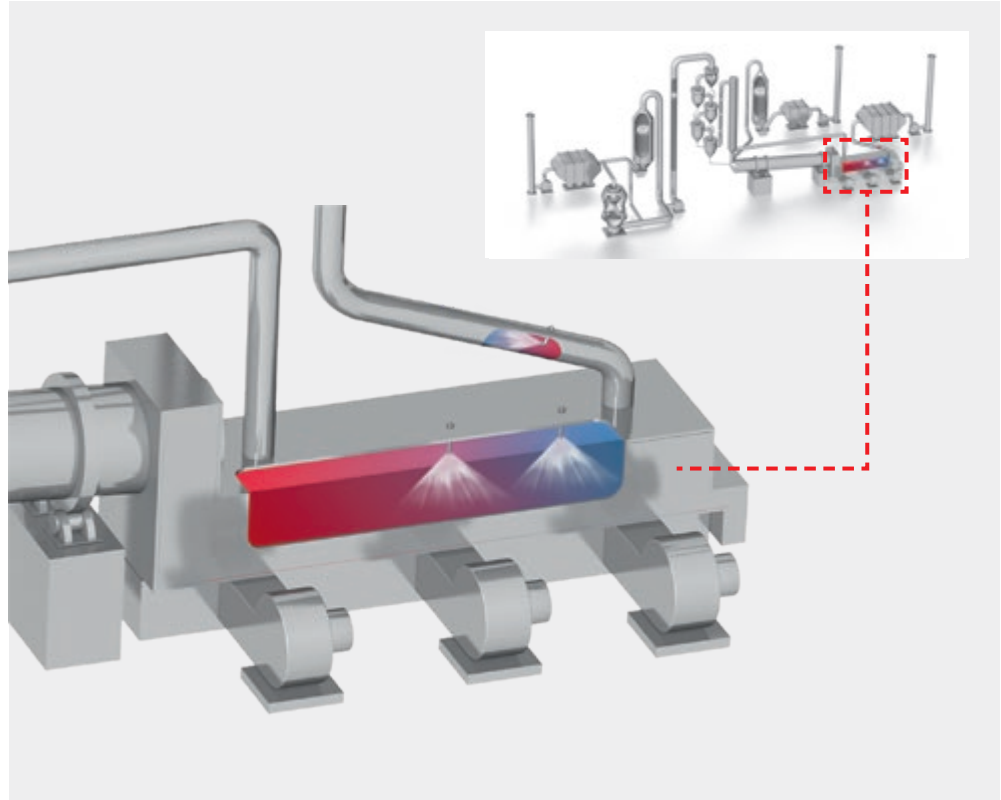

Our solution

The injection takes place at the rear part of the clinker cooler, immediately upstream of the gas outlet. Depending on the space above the clinker cooler, the nozzles can be attached both on the top and the side. We usually offer spillback nozzles for controllability. In comparison to conventional single-fluid nozzles, spillback nozzles ensure consistently fine droplets over the entire control range.

In addition to direct injection into the clinker cooler, injection is also possible into the duct downstream the clinker cooler. This requires a sufficiently long and straight-running evaporation section.

At a glance

Typical operating values

- Inlet temperature: 300–500 °C
- Outlet temperature: 270–320 °C

Objectives

- Increasing the capacity of the clinker cooler
- Reduced gas volumes for the filter
- Protection against overtemperature in downstream plant components
- Prevention of material build-up on walls and gas outlet duct



GAS COOLING APPLICATIONS BALL AND ROLLER MILL

Application

Heating during the grinding process can decrease the quality of the ground material. Through the injection of water into the ball mill, excess heat is dissipated and the outlet temperature is kept at the desired level.

Only if overtemperatures can be reliably avoided can the ground raw material or the ground cement be safely and efficiently conveyed and stored.

In the case of roller mills, the grinding bed is stabilized by the injection of liquid, thus optimizing the grinding process.

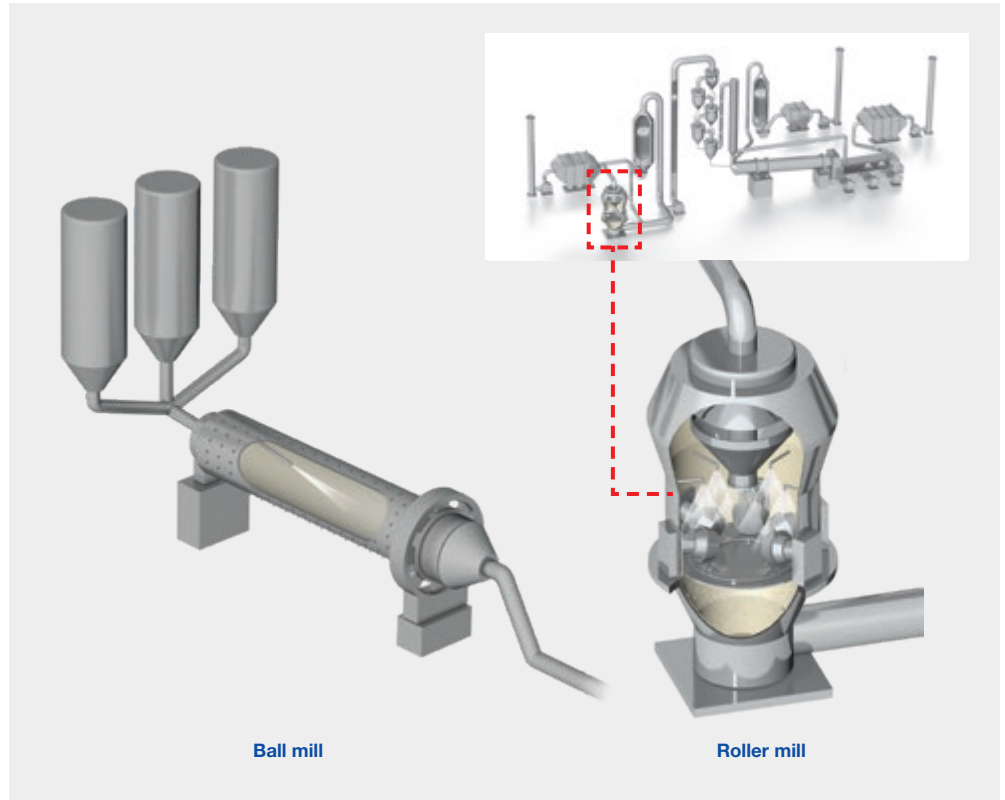

Our solution

We usually recommend single or twin-fluid systems for injection, optionally fitted with rotary feedthroughs for the lances.

CHOOSING THE RIGHT NOZZLE



Best results are achieved in gas cooling and conditioning processes only when detailed knowledge of process-specific requirements is available to assist in the choice of nozzles.

We will provide you with comprehensive advice taking your system and the applications you require into account. Our portfolio includes nozzles made of different materials for a wide range of droplet sizes and spray angles. The combination of your specific process requirements and our decades of experience results in a tailor-made solution for your needs.



Spillback nozzles

Atomization without compressed air



Lechler spillback nozzles atomize liquids as a fine hollow cone.

This special single-fluid nozzle works according to the pressure atomization principle. The water is sent to the nozzle with a relatively constant feed pressure, independent of the atomized flow rate.

The amount of liquid injected is adjusted via a control valve in the spillback line, whereby part of the flow is taken from the inlet flow rate and returned to the tank. The maximum atomized flow rate is achieved with the control valve closed.

Uniform and fine liquid atomization is achieved across the entire control range.

The atomized flow rate can be distributed over cluster heads with up to six small nozzles. This results in a total spray angle of approximately 120°. This wide distribution of liquid over the entire duct is advantageous for reducing the number of lances.

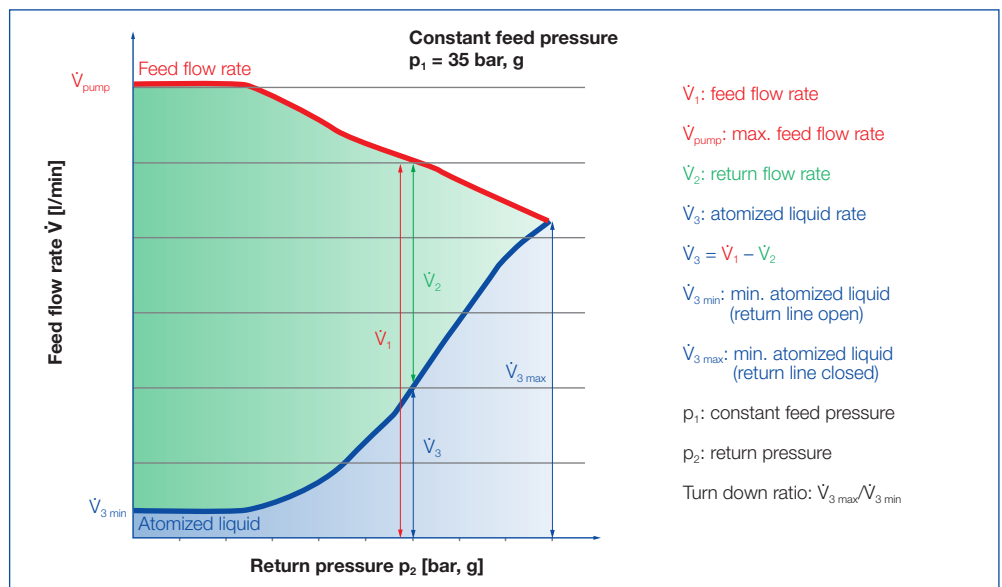
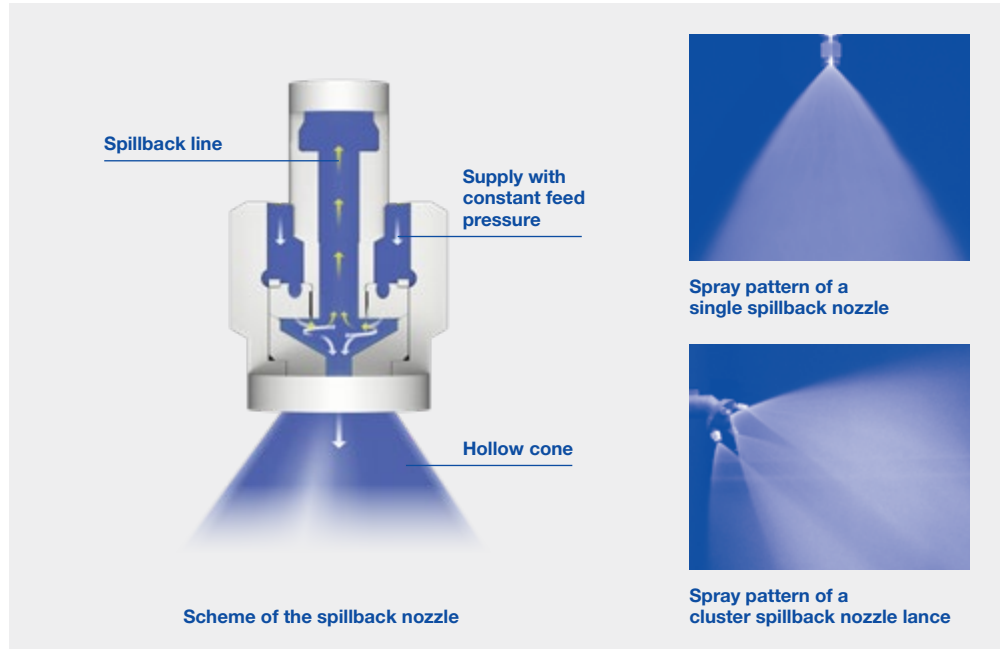

Use:

- Gas cooling in medium-sized and large gas cooling towers

Properties



Spray angle of the individual nozzles
90° or 60°
as hollow cone



Low operating costs as no atomizing air required



Execution
as single or cluster nozzle lances possible



High turn-down ratio
of up to 12:1



Even and fine liquid atomization
over the entire control range



Typical pressure range
of 35 bar, g in the supply line at the nozzle

VarioJet nozzles

Twin-fluid nozzles with low air consumption despite large outlet angle



Lechler VarioJet nozzles atomize according to the principle of internal mixing. With this twin-fluid nozzle, the water is fed in axially via a bore hole.

After arriving at the cone tip, the liquid is split up into a thin liquid film. This thin liquid film is split into finest droplets by the atomizing air in the mixing chamber. The resulting two-phase mixture is then atomized a second time when exiting via several bore holes arranged in a circular fashion.

Thanks to the innovative design of the nozzle, a spray with a large outlet angle is achieved. This is characterized by an even liquid distribution as well as a fine droplet spectrum with a low specific air consumption.

The fineness of the droplet spectrum is decisively influenced by the air/liquid ratio and by the pressure level of the two flow rates. As a general rule: the higher the air/liquid ratio and the higher the pressure level of atomizing air and liquid is, the finer the droplet spectrum.

The large free cross-sections in the nozzle keep the risk of clogging and the maintenance effort to a minimum.

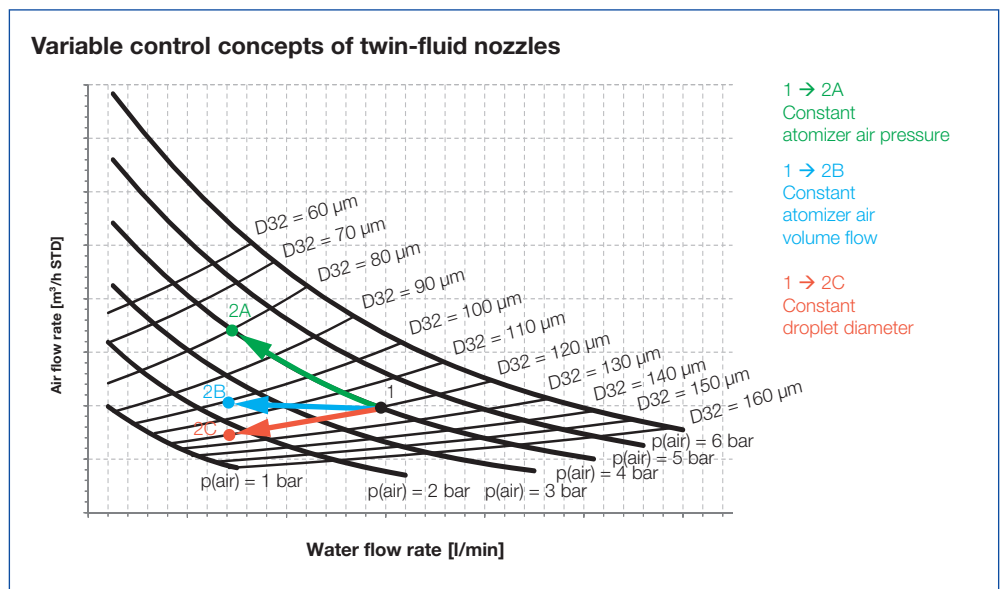
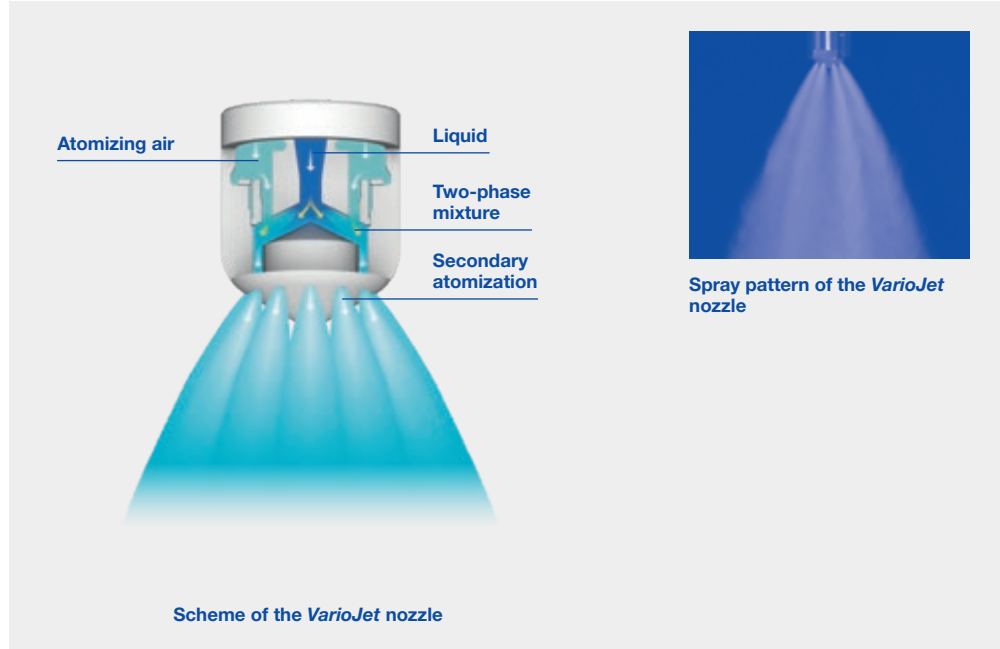

Use:

- Gas cooling in gas cooling towers as well as gas-bearing pipes (ducts)

Properties



Large spray angle
(60°, 90°) for good coverage of the cross-section of the duct



Adjustment of the droplet spectrum
by changing the air/fluid ratio



Clog-resistant
thanks to large free cross-sections without internal fittings



High turn-down ratio
up to 20:1



Low air consumption



Typical pressure range
Liquid 1–9 bar, g
Atomizing air 1–6 bar, g

Laval nozzles

Twin-fluid nozzles for a wide droplet spectrum in special applications



Lechler Laval nozzles

atomize liquids as a fine full cone. These twin-fluid nozzles work according to the supersonic principle.

A dual-phase mixture is created from atomizing air and liquid in the mixing chamber inside the nozzle. The shape of the nozzle causes this mixture to be accelerated to supersonic speed, resulting in an extremely fine atomization of the droplets.

By changing the air/liquid ratio, the droplet size and the droplet spectrum can be adapted within a wide range. The large free cross sections of the nozzle also allow atomization of viscous or solids-laden liquids.

Choosing the right material prevents wear even where abrasive media are present, and enables use at high temperatures.

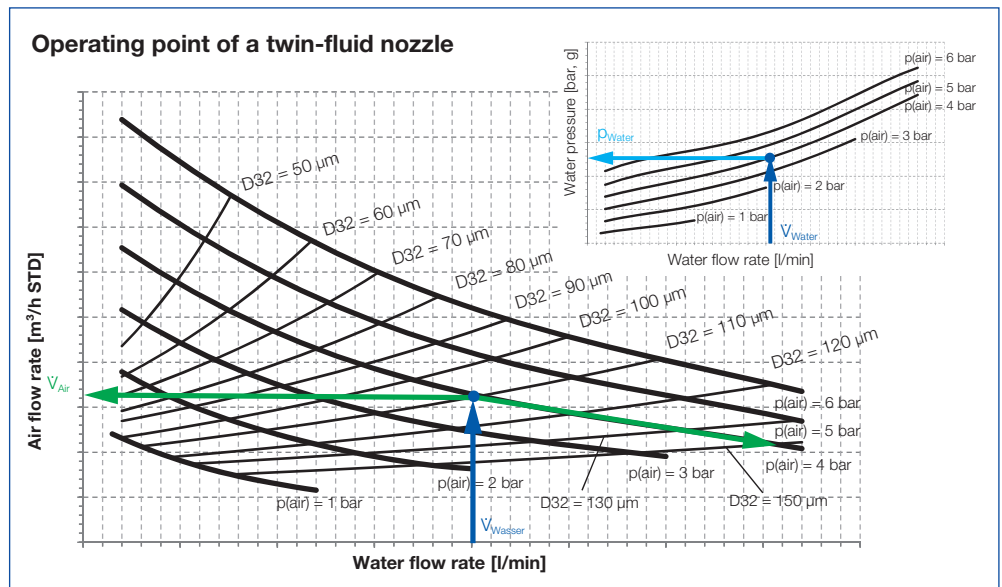
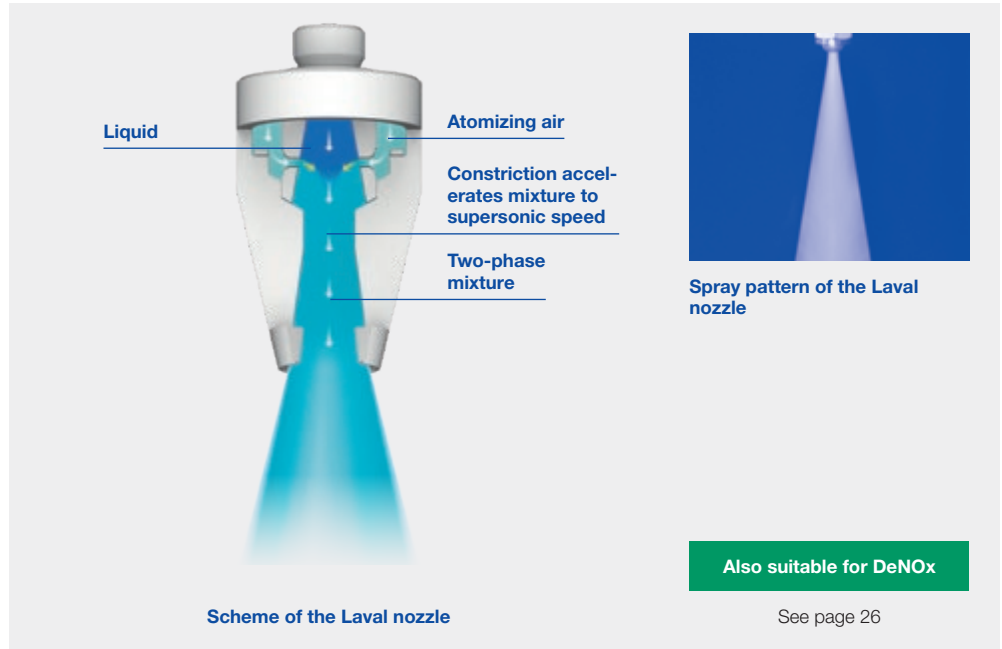

Use:

- Gas cooling in gas-bearing pipes (ducts) and medium-sized and small gas cooling towers
- Injection of solids-laden water
- Introduction of lime water in the desulfurization process
- Injection of aqueous ammonia or urea solution for the DeNOx process (SNCR/SCR)
- Chemical process engineering (spray dryers etc.)

Properties



Small spray angle (15°), suitable for small cross-sections and horizontal ducts



Adjustment of the droplet spectrum by changing the air/ fluid ratio



Clog-resistant thanks to large free cross-sections without internal fittings



Very large turn down ratio of 20:1 (in some cases up to 40:1)



Very fine droplet spectrum



Typical pressure range
Liquid 1–6 bar, g
Atomizing air 1–6 bar, g

Nozzle lances

Highest spraying accuracy in the flue gas duct

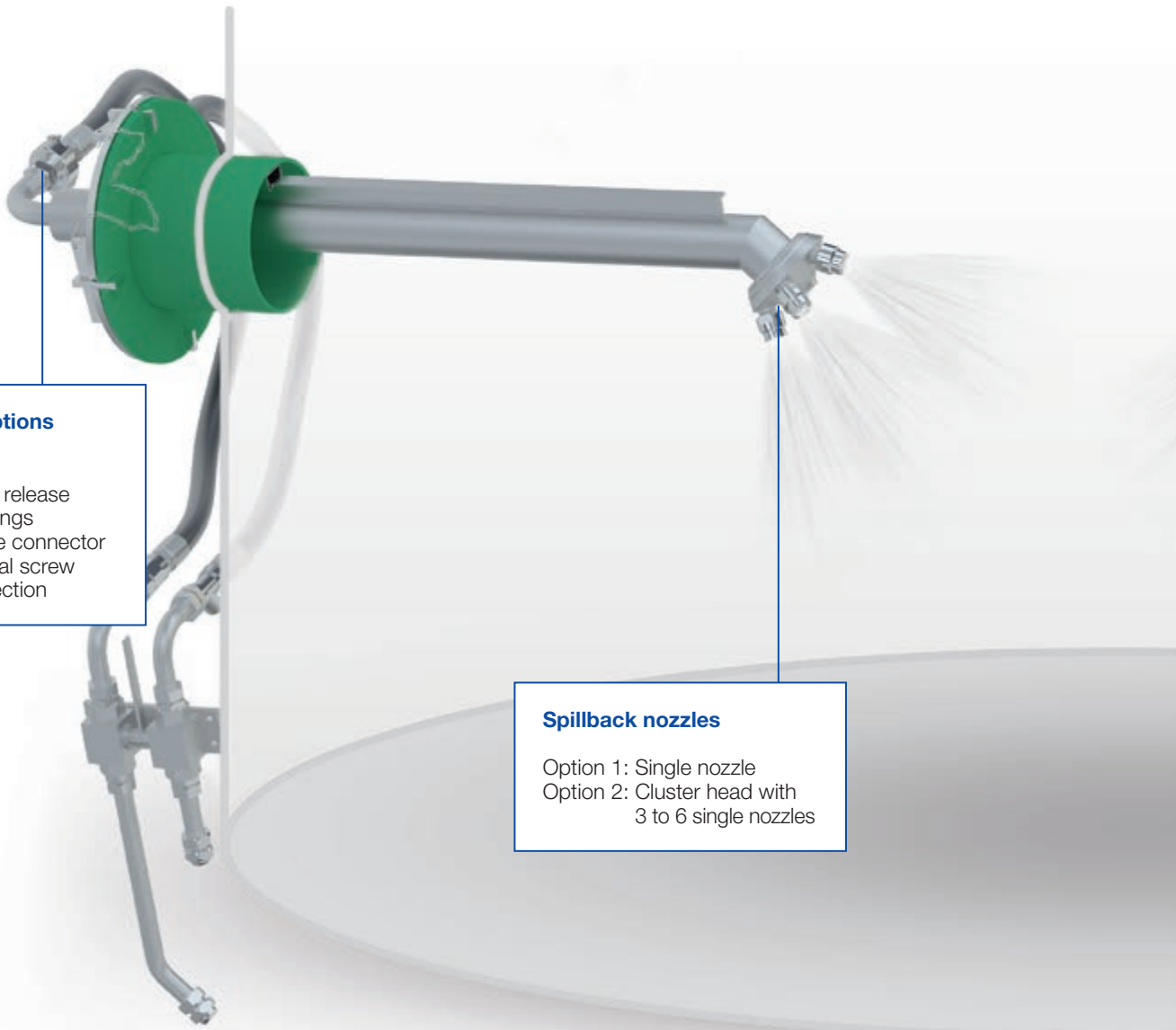

**Connection options
Accessories**

Option 1: Quick release couplings
Option 2: Flange connector
Option 3: Conical screw connection

Spillback nozzles

Option 1: Single nozzle
Option 2: Cluster head with 3 to 6 single nozzles

Lechler nozzle lances ensure optimal spray placement and alignment in flue gas ducts. The choice of nozzles and the consideration of local conditions and process-related matters means they can be individually adapted to the respective requirements.

The nozzles themselves have a low-maintenance design and can be quickly cleaned or exchanged with minimal effort.

The robust, high-quality stainless steel construction ensures a high degree of functional reliability. Lances are available in a variety of material to suit specific process requirements.

Lechler nozzle lances are available with many options, including but not limited to:

- Protection tube to increase the service life in case of higher temperatures, high dust loads and aggressive gases, with barrier air as an option
- Wedge flange, standard flange and special flange in accordance with customer requirements
- Guide rail to facilitate lance installation
- Shifting device to change the insertion length – with or without gastight sealing
- Expansion joint or stuffing box for expansion compensation at high temperatures
- Assembly connecting piece with flange connector for welding onto flue gas duct
- Further special customizations including wear protection, insulation, water cooling or coating
- Pre-assembled accessory kits for process media connections (e.g. quick release couplings, shut-off ball valves, strainers)

Lechler nozzle lances are manufactured in line with ultramodern production processes and according to the state of the art.

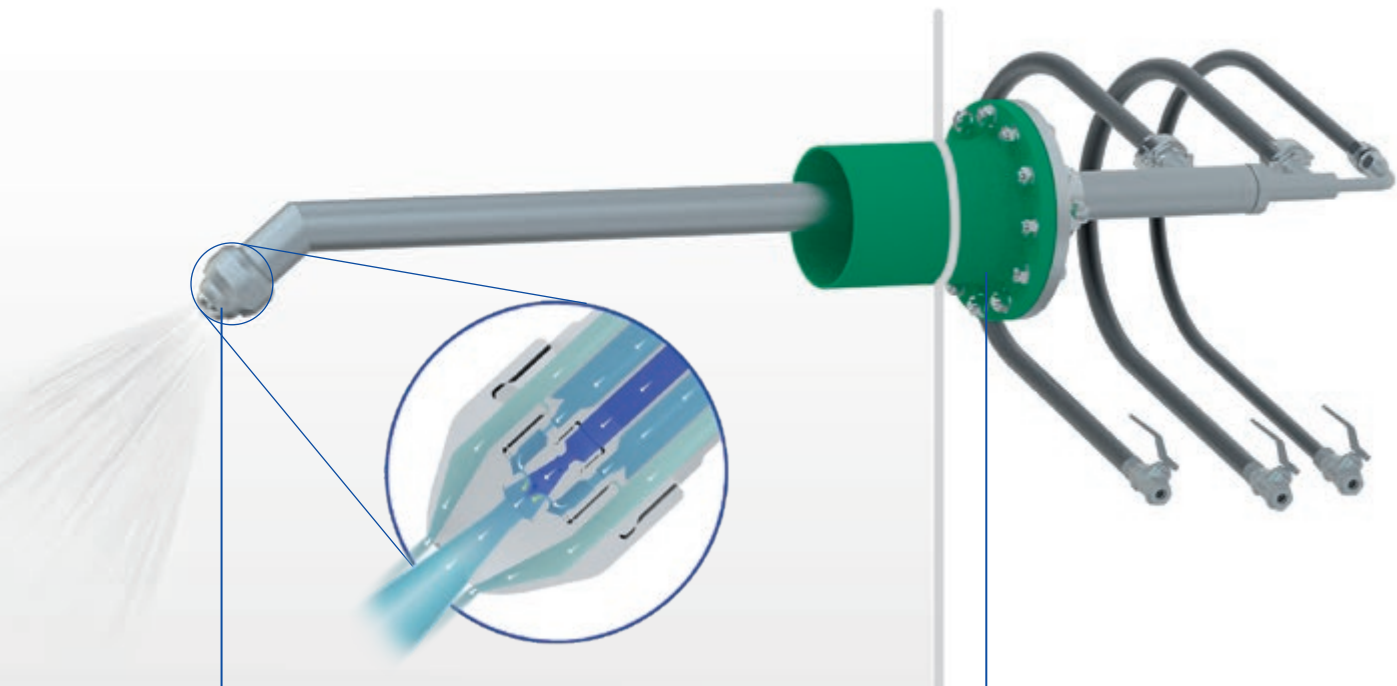

VarioJet nozzle

Option 1: Without protection tube and without protection cap
 Option 2: With protection tube and with protection cap

Flange connections

Option 1: Wedge
 Option 2: Standard flange e.g. DIN, ANSI etc.
 Option 3: Special flange according to customer specification

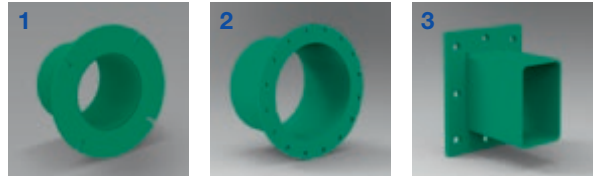

Material

Lances are manufactured from stainless steel (316/316L) as standard, but depending on requirements can also be made of chemical and high-temperature resistant materials.

Accessories are available in galvanized steel or stainless steel and the hoses are available in rubber or stainless steel.



Talk to us

Each gas cooling tower and flue gas duct is different. Which is why standard solutions do not always make sense. Speak with us and let us work together to find the best solution for your purposes.



VarioCool gas cooling system

For a perfectly tailored solution

Our valve skid units for regulating the flow rates of water and atomizing air are individual customer-specific solutions. Based on the requirements in each case, our first step is to design an overall concept and select the best components in order to create a perfectly tailored solution.

First-class engineering

To perform our engineering, we determine all relevant parameters and define the plant's design. This includes determining the nominal widths and pressure levels as well as designing the pumps and control valves. We draw up the P&I diagram and make detailed equipment and signal lists as an option. Of course, the project is fully documented to ensure that technology and processes can be quickly traced even after years of use.

High-quality components

An exact knowledge of the characteristic properties of our nozzles is key here. For only a complete system that is coordinated to how the nozzles function and operate will ensure smooth and economical operation of the gas cooling system. The service life of the products used is key to a cement plant's profitability. Unexpected failures can quickly lead to plant stoppages and costly production outages. Which is why we fit our valve skid units with high-quality components from well-known manufacturers as standard and the most important functional components are even realized in redundant design.

The components are interconnected with pipes and mounted on a stable base frame with eyelets for crane transportation, at the same time ensuring that all components for operation and maintenance are arranged in an easily accessible manner.

Tested quality

The design (e.g. dimensioning of nominal widths) and production are in line with the latest state of the art and comply with all relevant standards. They are equally subject to the Lechler quality management system certified to DIN EN ISO 9001, as is the final acceptance. Before delivery, the valve skid unit undergoes a pressure and tightness test and is checked by our experienced engineers. This will avoid any problems during commissioning.

Control concept from the nozzle specialist

Numerous installations of *VarioCool* systems, years of commissioning experience, plus expertise in nozzle technology all contribute to the constant improvement and optimization of Lechler control systems. By installing a control solution from Lechler you will benefit considerably from this wealth of experience. The flexible and fully automatic concept can be perfectly adapted to your process. You will have start-up and shut-down scenarios and dynamic process conditions under perfect control with our solution.



Option packages for our VarioCool valve skid units

Electrical wiring of the components:



Junction box

All components except the pump motors are wired to a junction box within the valve skid unit.

This assures that the customer has a central connection point for all electrical components and measuring devices for further processing in the higher-level control.

Control cabinet with complete PLC

All components including the pumps are wired to a control cabinet. The control cabinet is integrated into the base frame of the valve skid unit.

The complete injection control is tested in accordance with valid electrical standards and regulations and allows all relevant process parameters to be visualized over a control panel on the control cabinet.

Specific configuration and extensive testing make commissioning much faster. Communication and the exchange of signals (setpoint, plant status, error messages) with the customer's logic system is carried out via PROFIBUS or PROFINET.

The control has several modes of operation such as automatic mode and manual mode for tests during plant downtimes. In the event of faults, our engineers can quickly perform a remote diagnosis via the installed modem without the need for an on-site visit.

VarioCool gas cooling system

For a perfectly tailored solution

Extended scope of delivery

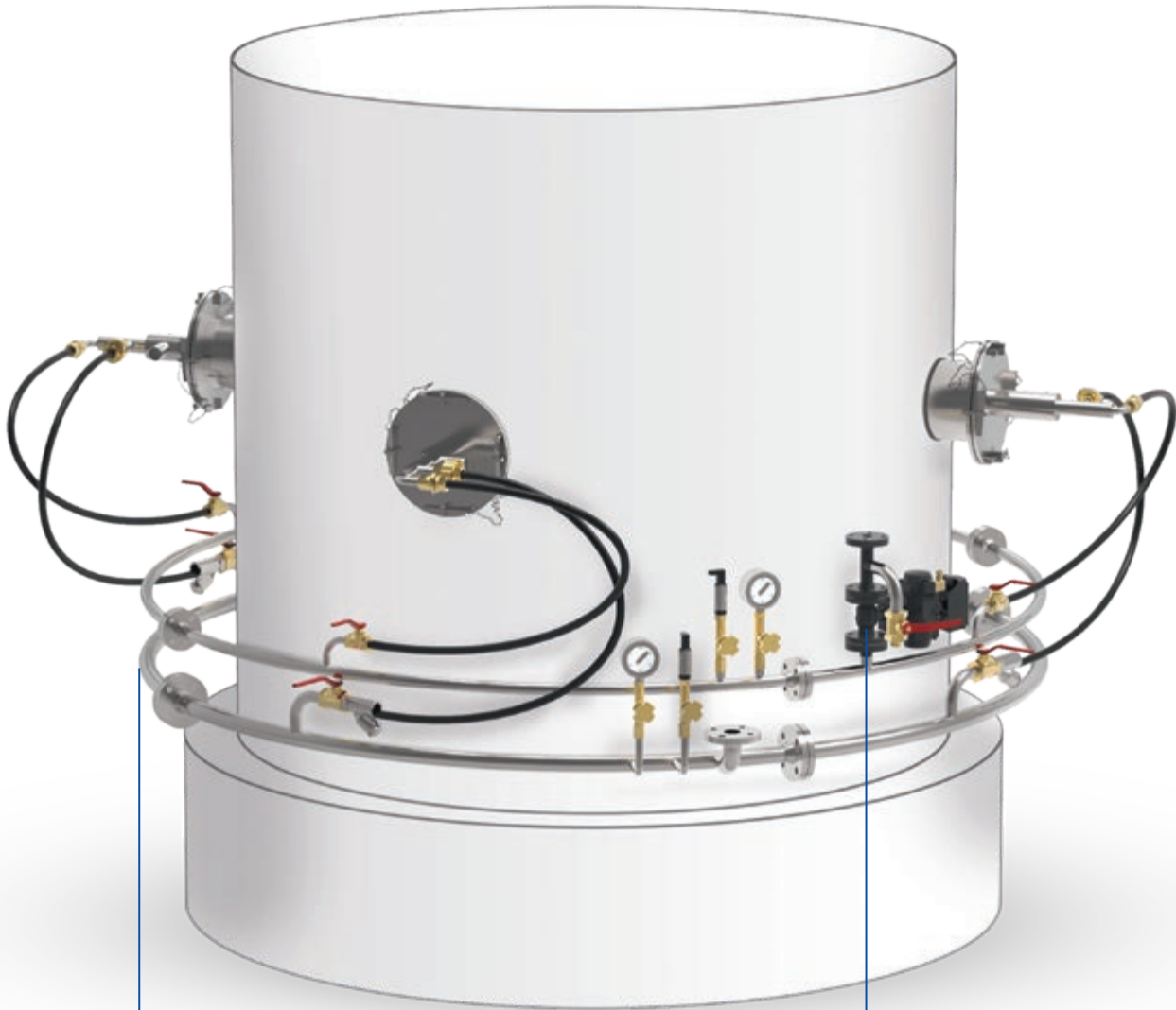

Ring mains

Ring mains are usually used to supply the lances. Lechler supplies ring mains and headers together with the corresponding brackets for welding onto the flue gas duct. Accessories such as pressure transmitters and manometers plus the appropriate connections for the lances and supply lines are also included in the scope of delivery.

Purge air connection

In order to increase the injection turn-down ratio, individual lances or lance groups can be connected or disconnected. If the disconnected lances are in the flue gas duct, the rest of the fluid should be purged. Vaporization and deposits in the lance can be prevented in this way.

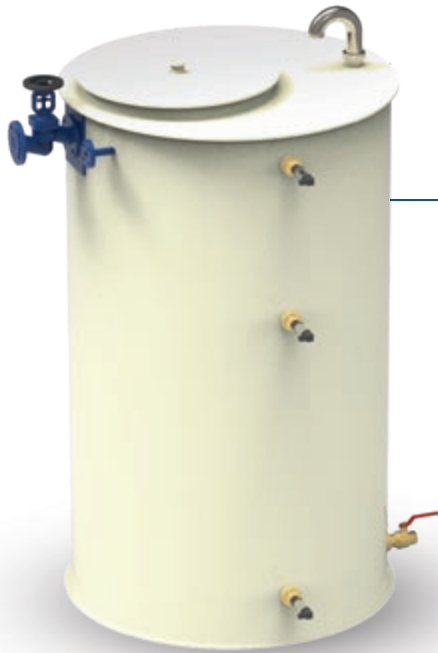

Water tank

A water tank made of steel or plastic serves as a reservoir for the valve skid unit and guarantees injection operation for a certain period of time in the event of the water supply failing. Its size is adapted to the injection quantity. The components for tank filling and level monitoring are included in the scope of delivery.



Barrier air fan

In order to protect the nozzles and lances from dust deposits and/or high temperatures, barrier air is frequently applied to them. For this purpose, Lechler supplies fans geared to the specific application with various optional attachments such as a throttle valve, suction filter and silencer.



Temperature measurement

For a constantly regulated outlet temperature, it is very important for the response characteristics of the temperature sensors to be adapted to the ambient conditions. Lechler provides the appropriate thermometers and assists you in defining the installation position.



Talk to us

Do you require an option that is not listed? Or are you having planning issues? No problem. Tell us what your requirements are. We will find the appropriate solution and ensure a seamless integration.



GAS CONDITIONING DENITRIFICATION (DeNO_x)

In **DeNO_x applications**, twin-fluid nozzles are used as a general rule, whereby the reagent (typically aqueous ammonia or urea solution) is atomized with compressed air. The advantage that twin-fluid nozzles have compared to single-fluid nozzles lies in the controllability of the droplet size and in the realization of a large flow-rate control range. Due to the varying local conditions (duct size, gas velocity, temperature etc.) and

the different response characteristics of the injected media, it must be possible to control the droplet size and thus the depth of penetration.

In DeNO_x applications with SNCR processes, small Laval nozzles are usually used. For SCR processes and special SNCR applications there are special nozzles available.

Injection of aqueous ammonia

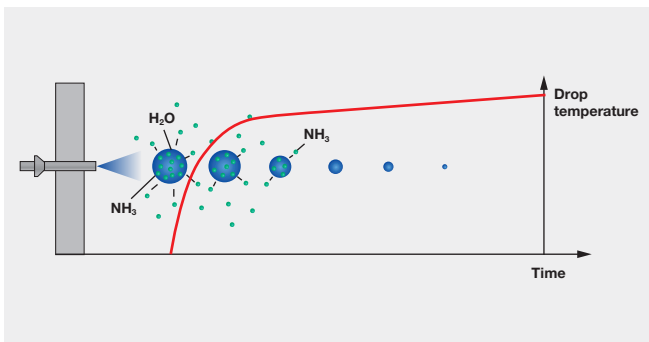

When injecting aqueous ammonia, the evaporation process of ammonia and water starts immediately after leaving the nozzle.

Injection of urea solution

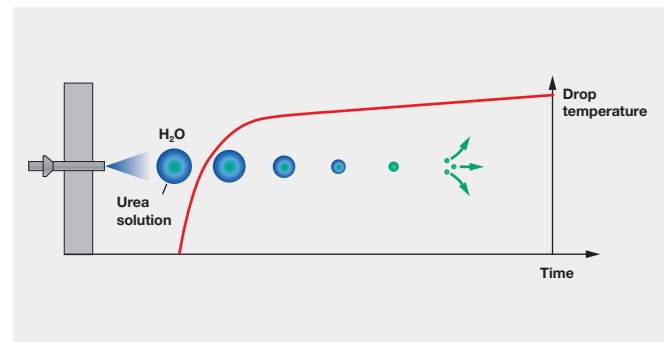

In the case of urea solution, the water must evaporate completely first before the urea can split into its components and the NH₃ can react with the NO_x.





GAS CONDITIONING DENITRIFICATION (DeNO_x) SNCR

Application

Depending on the different process variables, emissions of harmful nitrogen oxides (NO_x) occur during the production of cement. In an effort to reduce these, many countries have already lowered the respective limit values – some even to a daily average of 200 mg/Nm³.

At the same time, substitute fuels are increasingly being used such as those from municipal waste disposal. Due to the different conditions of combustion (air volume, different heating values), there are increased demands on the control of DeNO_x systems to adhere to the emission limit values.

After the primary reduction measures relating to the firing process, the secondary measures are also of crucial importance for optimal process results in NO_x reduction.

Drawing on our extensive expertise, we assist you in complying with limit values with our SNCR systems.

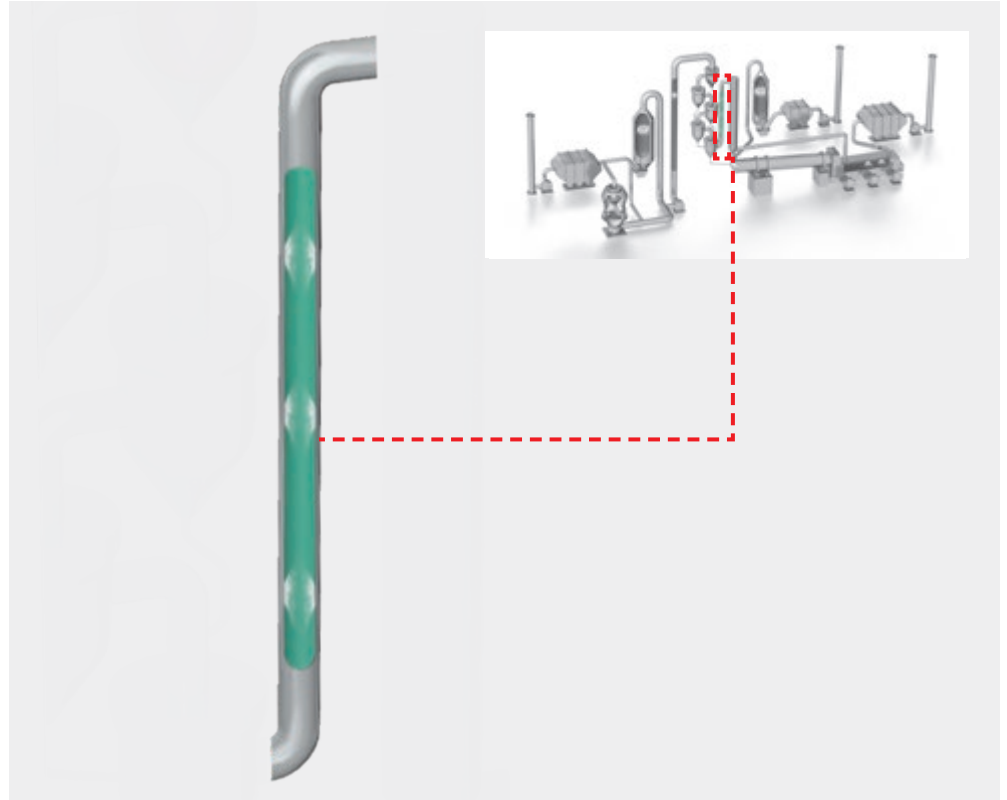

SNCR

For the non-catalytic reaction, a reagent (mostly aqueous ammonia) is specifically injected in the area of the optimum temperature window of approx. 950–1,050 °C. Exceeding or falling below the tem-

perature window will lead to additional NO_x formation or an increase in the NH₃ slip. The efficiency is reduced in both cases. In addition to the optimum temperature, parameters such as droplet size and velocity are also

of crucial importance. Only with the appropriate nozzle and the right control concept can the droplets penetrate deep enough into the flue gas flow to ensure optimum distribution of the reducing agent in the flue gas flow.

Our solution

Lechler nozzle lances for DeNO_x applications are fitted with special nozzles. The lances can be realized with all options such as protection tube, shifting device and expansion compensator. The nozzle lances are designed and manufactured in accor-

dance with the process requirements and meet the specifications for DeNO_x applications.

Our range of solutions includes DeNO_x systems for different specified limits. In addition to the *VarioClean* – NO_x starter

system, Lechler has joined forces with **STEAG** to provide a modular SNCR system that can also be extended at a later time in line with requirements.

The different configurations help you to not only adhere

to the specified reduction levels and slip values, but also lower reducing agent consumption by 30% and more. Depending on the price of the reagent, this leads to a significantly quicker ROI for the injection system.



GAS CONDITIONING DENITRIFICATION (DeNO_x) SCR

Application

In the SCR process, the reducing agent is injected before the catalyst. It must be distributed as homogeneously as possible in the flue gas flow and evaporate before reaching the catalyst.

In practice, static mixers are often used in addition to the nozzles to mix gas and reducing agent. This makes extremely short evaporation distances possible at a low temperature level of approximately 300 to 400 °C.

In order to ensure complete evaporation over this short distance, Lechler has developed twin-fluid nozzles with extremely fine droplet spectra and precise controllability. They meet the demands placed on them and have proven their worth in cement factories.



SCR

With the selective catalytic reaction (SCR), achieving a high separation efficiency is possible only with the aid of a catalyst. Due to the high

concentration of dust, such a solution requires special precautions to keep the efficiency high and catalyst waste low. The reagent is

added immediately before the catalyst using the nozzle lance in a temperature window appropriate for the reaction.

Our solution

Depending on the customer's process design, Lechler provides the appropriate nozzle lances and where necessary, the injection system as well.



GAS CONDITIONING DENITRIFICATION (DeNO_x) IN LONG KILN

Application

Long kiln technology can still be found in older cement factories in the USA, Russia, Asia and South America in particular. But even in these countries, ever lower emission limit values are forcing plant operators to apply secondary measures for NO_x reduction in exhaust gas.

To reduce the nitrogen oxides in the flue gas of such plants, a special injection system needs to be retrofitted. Only in this way can the reagent be brought into the optimum temperature range inside the rotating kiln.

The practical implementation of this process requires a high degree of technological and process knowledge.

In the case of plants with conventional long kilns, the challenge is above all to realize an injection system that is able to successfully master the interface between the stationary valve skid unit and the rotating kiln. Due to the eccentricity of the long kiln, the center of kiln entry moves during operation. It is

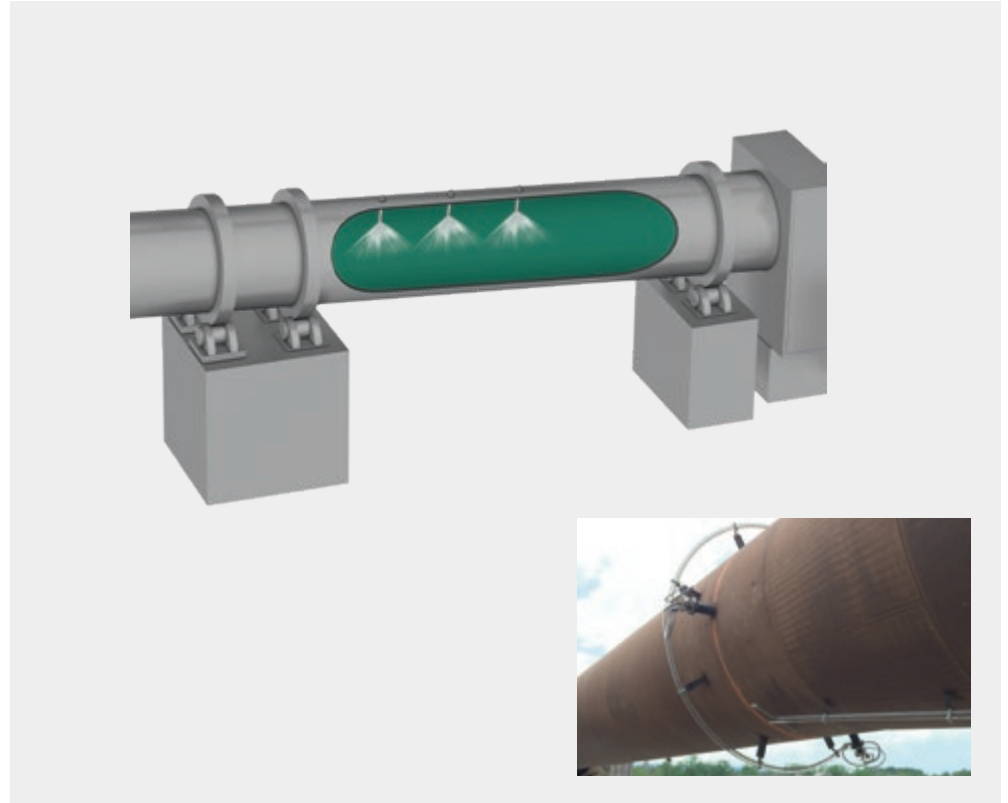

moved further still by thermal expansion. These factors and their consideration alone shows just how complex the task is.

A further challenge is the selection of the material for the nozzle lances and other components in the kiln. These are constantly rotated during the firing phase by the hot material within the kiln.

Our solution

The scope of delivery for these injection systems covers the customized design and supply of valve skid units, pipe systems for the decoupling of rotating and static components, pipelines in and on the kiln as well as injection lances within the long kiln.

Lechler has already installed more than 15 injection systems in the USA which are even below the required emission limit values and at the same time comply with NH₃ slip requirements.

Special twin-fluid nozzles for DeNOx applications

Laval nozzle

In DeNOx applications with SNCR processes, small Laval nozzles are usually used. These nozzles are characterized by a high discharge velocity, enabling the optimum droplet spectrum to be introduced into the reactor with a great penetration depth.

Our research has shown that the discharge velocity has a greater effect on the denitri-fication process. Moreover, these nozzles without internals are extremely insensitive to clogging and can be precisely controlled.

See page 15 for more information

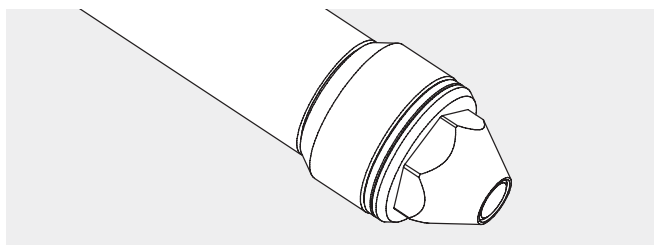

Special properties



Small spray angle (15°), suitable for small cross-sections and horizontal ducts



Turn-down ratio of 20:1 (in some cases up to 40:1)



Typical pressure range
Liquid 1–6 bar, g
Atomizing air 1–6 bar, g



Very fine droplet spectrum



Adjustment of the droplet spectrum by changing the air/liquid ratio



Spray pattern of a Laval nozzle

For SCR processes and special SNCR processes there are special nozzles which have been developed to meet the specific requirements. The same principles regarding control and operation apply for all twin-fluid nozzles, irrespectively of the type.

Laval flat fan nozzle

The Lechler Laval flat fan nozzle atomizes according to the principle of inside mixing. The air/fluid mixture exits via three outlet holes creating a wide and flat spray with an even better surface coverage.

The droplet spectrum and the pulse of the droplets can be adapted by changing the air/ fluid ratio.

Special properties



Wide and flat jet, spray angle 60°



Turn-down ratio of over 10:1



Typical pressure range
Liquid 1–5 bar, g
Atomizing air 1–5 bar, g



Spray alignment possible



Adjustment of the droplet spectrum by changing the air/ liquid ratio

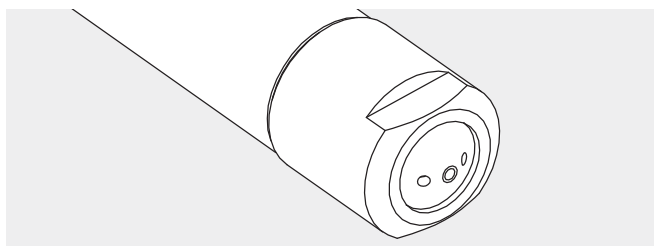

Spray pattern of a flat fan nozzle

MasterNOx for DeNOx processes

The Lechler *MasterNOx* nozzles are usually used in the non-catalytic denitrification of flue gases (SNCR process). They are usually designed as flat fan nozzles and achieve a high spraying range to make the liquid penetrate as far as possible into the boiler. The

nozzle specially developed for the retrofitting of existing power plants is characterized by a small outer diameter, so that it can fit between the pipes of the boiler wall. It can also have a protective flow of barrier air around it without the need for the pipes to be bent aside.

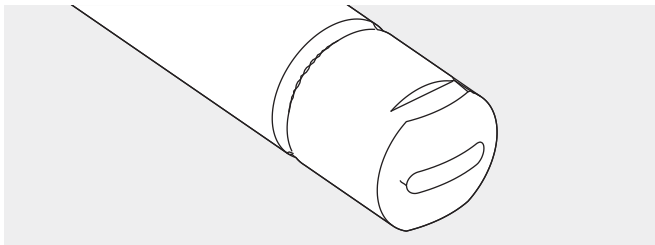

Special properties



Spray angle
15°, 30°, 60°



Turn-down ratio
of over 50:1



Typical pressure range
Liquid 1–10 bar, g
Atomizing air 1–6 bar, g



Adjustment of the droplet spectrum
by changing the air/liquid ratio



Spray pattern of a *MasterNOx* nozzle 30°

1AW nozzle

The Lechler 1AW nozzle works according to a newly developed and patented atomization principle. It divides the supplied atomizing air into a primary and secondary air flow. Thanks to the specific in-flow geometry, the secondary air exits through an annular gap causing a very fine atomization in the edge region of the spray.

This twin-fluid nozzle enables finest droplet spectra and shortest evaporation distances while also allowing very good controllability of the flow rate. Cluster heads designed specifically for these nozzles multiply the flow rates and adapt the spray pattern to the requirements at the point of injection.

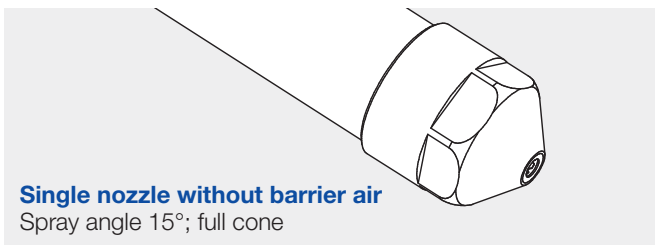

Single nozzle without barrier air
Spray angle 15°; full cone

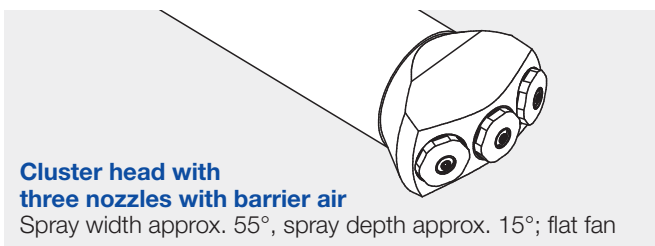

Cluster head with three nozzles with barrier air
Spray width approx. 55°, spray depth approx. 15°; flat fan

Special properties



Spray angle of the individual nozzle
15° as full cone



Turn-down ratio
of 10:1



Typical pressure range
Liquid 1–5 bar, g
Atomizing air 1–5 bar, g



Particularly fine droplets thanks to tertiary atomization



Design
as single or bundle nozzle lances



Adjustment of the droplet spectrum
by changing the air/liquid ratio



Spray pattern of 1AW nozzles

VarioClean – NOx

The powerful starter system

Lechler VarioClean – NOx is the entry-level system for the SNCR process. Standardized units with fixed components allow for affordable pricing, all while maintaining Lechler's famous high quality standard.

Included with delivery are a valve skid unit including pumps and fittings for media control as well as individual modules enabling the lance levels to be connected and disconnected. The components of the valve skid unit are connected with pipes and assembled on a compact base frame including all brackets. Assembling in a two-door closed cabinet is also possible as an option.

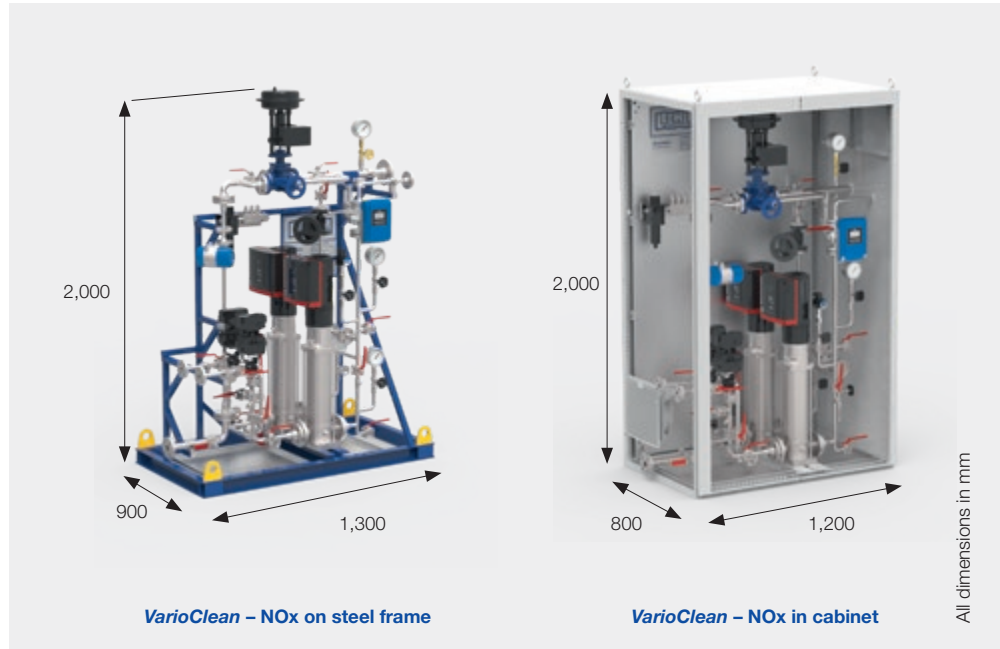

VarioClean – NOx on steel frame

VarioClean – NOx in cabinet

Features:

- Two sizes
- Reducing agent injection quantities of 0.005–1.0 m³/h or 1.0–2.7 m³/h
- Frequency-controlled pumps with magnetic couplings (duplicated)
- Permanently technically sealed in accordance with DIN EN 1127-1
- Optional integrated gas detector
- Integrated drip tray
- In accordance with DIN EN 1295 2-14: X-ray examination of 10% of all welds capable of validation
- 3.1 material certificates in accordance with DIN EN 10204
- Integrated flush connection
- Integrated air flushing for non-active levels
- Standardized technical documents for simple implementation in higher-level operating documentation

The Lechler VarioClean – NOx system is an independent SNCR system and is not designed for later upgrading with more efficient Lechler systems.

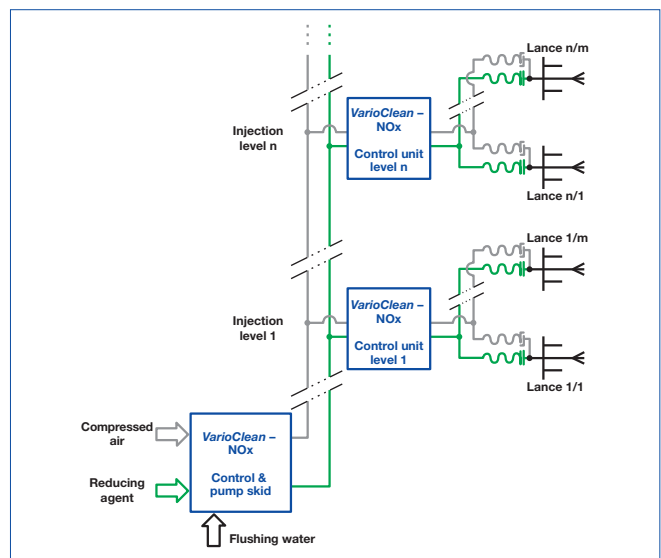

Lechler VarioClean – NOx system

VarioClean – heSNCR

The denitrification solution that grows with the requirements

In recent years, the requirements for reducing NO_x emissions have been significantly increased in many countries. Meanwhile, primary measures are no longer sufficient, so that cement manufacturers have to decide how to comply with the current emission limits.

For this purpose, Lechler, in cooperation with STEAG Energy Services GmbH, has developed a sophisticated high-efficiency SNCR concept for cement plants that reliably complies with the respective applicable limits: *VarioClean* with “high efficiency SNCR (heSNCR)”.

The STEAG/Lechler high efficiency system is based on many years of experience with sophisticated SNCR systems in cement plants. We have more than 10 references in Germany with the rather challenging requirements of a NO_x reduction of more than 85 % in combination with a NH₃ slip of max. 30 mg/Nm³. Furthermore, we have many references worldwide with installations in China where limits of 100 mg/Nm³ could be achieved.

Depending on the individual requirements and the legal situation on site, the modular design of the *VarioClean* – heSNCR can be flexibly

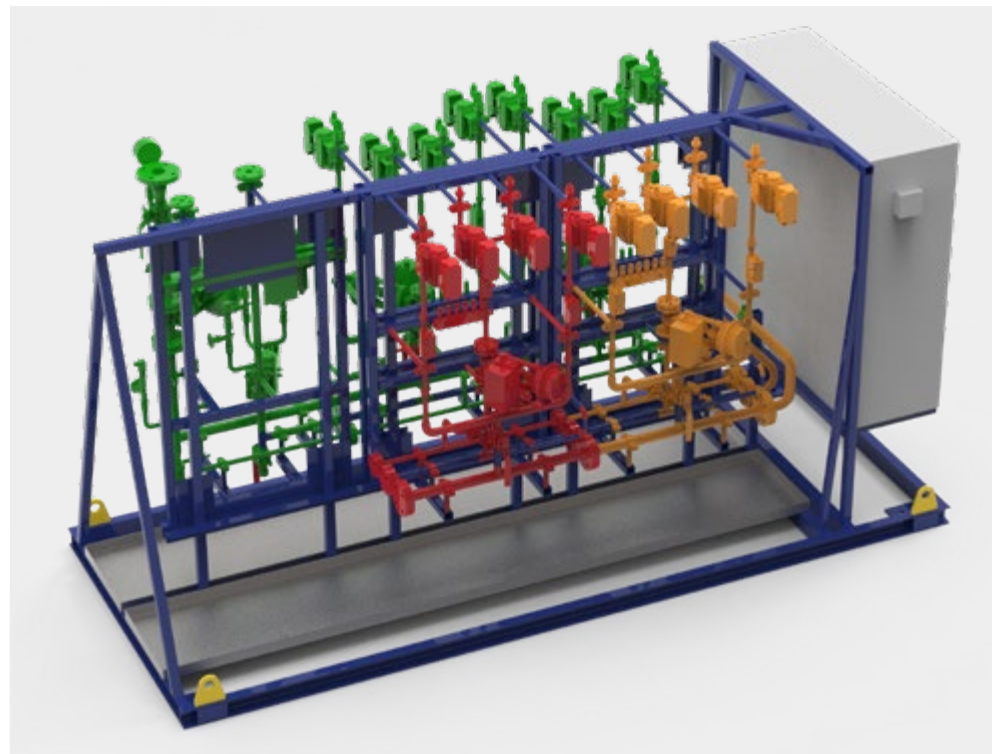

adapted. Regardless of the number of lances selected, the base frame, inlet module and control cabinet are always of the same design. Each of the identically constructed injection modules supplies two lances. The required injection modules are implemented depending on the number of lances selected. Due to the modular design, further injection modules for

up to 10 lances can also be added at a later time, if the limit values should be changed in the future. The reagent quantity is controlled individually for each injection module. This ensures that the right amount of reducing agent is injected at the right time and in the right place. For optimum distribution and injection of the reagent, Lechler Laval nozzle lances are used to

accelerate the two-phase mixture to supersonic speed to ensure optimum penetration into the gas stream and optimum droplet size.

Our *VarioClean* – heSNCR system reliably meets current limits while minimizing reagent consumption and is also prepared for the future.

VarioClean – heSNCR

The denitrification solution that grows with the requirements



Due to the distance between the injection lances and the emission measuring point, there are dead times of several minutes between the application of the reagent and its visible effects. In addition, different operating states of the cement kiln lead to different distributions of the resultant nitrogen oxides. A conventional PID control can only react to changes in emissions after the dead time; it is not at all suitable for taking different NOx distributions into account. Modern Advance Process Control (APC) modules offer superior control solutions here.

Based on relevant operating data of the cement plant over

a period of at least four weeks, predictive models are developed to estimate the NOx load and the required amount of ammonia to be introduced (feed-forward control). In a further step (exploration phase), the control system continuously varies the distribution of the reducing agent over the various injection points in order to determine the lances that are currently working best.

As a result, the system automatically adapts to the current operating conditions so that the specified limits are reliably met with minimum consumption of ammonia water.

The main benefits of the STEAG/Lechler heSNCR are as follows

- Strict compliance with NOx- and NH₃-emission limits
- Low operating and maintenance costs
- Practically maintenance-free
- Fully automated control modules using APC
 - Intelligent set-point control
 - Adaptive NOx prognosis
 - Optimum quantity of ammonia-water injection
 - Optimum ammonia-water distribution due to Adaptive Lance Select module (ALS)
 - Control of Lance operability
- Valve skirts completely durable tight therefore no additional ATEX requirements
- Pumps with frequency converters to provide constant outlet pressure and thus enlarged turn down ratios of the control valves
- Each pair of lances can be flushed and maintained individually while SNCR process is still running
- Individual flow detection of the lances so that clogging of lances can be detected online (Part of STEAG Monitoring System)

Talk to us

Different systems require different strategies. The largest and most comprehensive solution is not always the best one. Let us discuss your requirements and work together to find the denitrification system that is a perfect fit today and will grow with increasing requirements tomorrow.



CFD Analysis

Flow optimization with computational fluid dynamics

You can't just guess at perfection, it must be precisely calculated

The flow behavior of gases is significantly determined by the geometry of the environment. By applying computer simulation using computational fluid dynamics (CFD), our specialists can detect unequal gas distributions as well as turbulence. Depending on the specific conditions, these issues can be resolved in different ways. Installing baffles, perforated plates or even repositioning nozzles can be simulated to achieve the desired flow characteristics. The result of optimized gas flow via CFD can significantly reduce energy and/or material requirements.

Optimization of the gas flow in the gas cooling tower

Benefits:

- Efficient cooler operation thanks to lower atomizing air consumption and/or lower connection pressures at the nozzle lances
- Wet ground avoided as well as possible caking on the inner wall of the cooler
- Stable process in various load cases



Optimization of SNCR process – best possible selection and placement of nozzles

Benefits:

- Reactive ammonia vapor is present where the gas containing nitrogen (NOx) flows
- Avoidance of unnecessary NH₃ slip, meaning efficient use of the ammonia solution
- Best possible reduction rates of nitrogen oxides

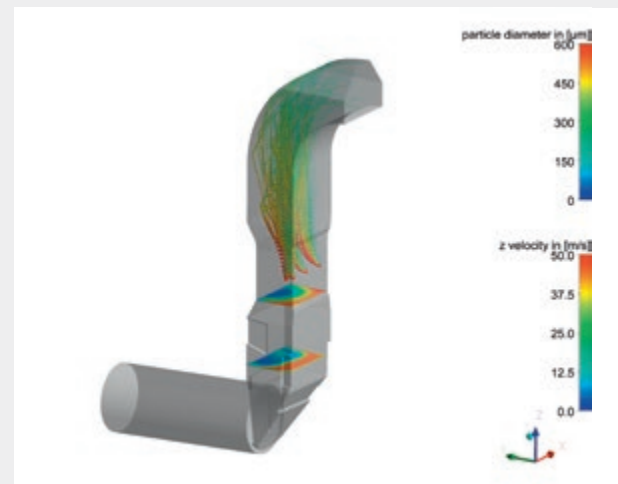

Design and continuous optimization of our products

Benefits:

- Optimal atomization effect
- Efficient use of the connected atomization media
- Reduction of the required nozzle connection pressures
- Individual nozzle development in the shortest time

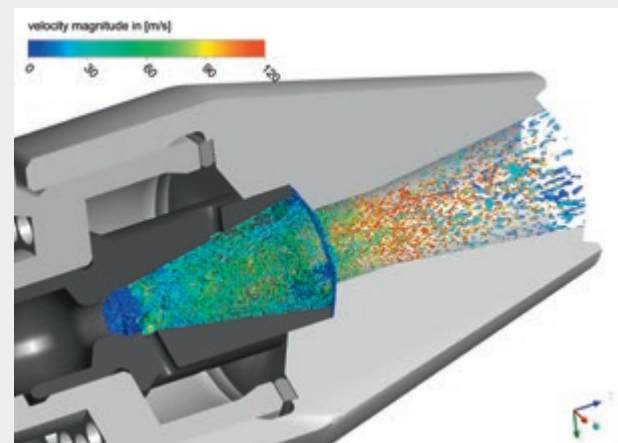

ENGINEERING AND SERVICE

Our experience for your success

With our experienced engineering team, you have a competent contact for your project at all times – from technical design and detail engineering to commissioning and replacement of spare and wearing parts. You will benefit from direct contact and fewer communication channels to enable smooth completion of your project.

Exclusive solutions

Lechler offers a system solution tailored to your application and plant-specific conditions. We use only high-quality components from renowned manufacturers for our valve skid units. If you choose a system with a control, you will get a complete solution for your gas cooling and conditioning requirement from a single source.

Reliable service is part of our agreement

Lechler is Europe's No. 1 nozzle manufacturer. A key factor for this success is our service. For even after your system has been delivered, you are in good hands with Lechler. We offer a worldwide commissioning service provided by employees with many years of experience. A signal and performance test ensures optimal system operation taking all operating and safety aspects into consideration. An important point of commissioning is also the detailed briefing of operating and maintenance personnel in the operation and maintenance of the plant.

We are your competent partner who will provide you with assistance to solve your problems. Our on-site service for preventive maintenance ensures continuous operation. We will be more than happy to draw up a maintenance contract tailored to your needs.

From digital to real

Each individual design of gas cooling and conditioning systems is based on innovative software. CFD calculations are used for flow optimization. Using a 3D tool, we identify the optimum liquid distribution in the duct together with the necessary lance arrangement.

Our drawings are created using state-of-the-art design engineering software.

Extensive documentation

Our nozzle lances and systems are designed and manufactured in line with the current standards and regulations. New plants are always delivered with project-related documentation containing all relevant information for commissioning, operation and maintenance. Lechler will also provide a verbal description of the function and control concept where desired.

Future-proof

Lechler systems are built to withstand harsh conditions and enable reliable and long-term operation. But we too have to lend to the extreme process conditions in the cement industry. Which is why it is all the more important to us to have a guaranteed long-term supply of spare parts for wearing parts – worldwide. With our global network of representatives, we offer a worldwide platform for contact and advice. You will find your competent contacts on the Lechler website.





MEASURING TECHNOLOGY HOW OUR RESOURCES HELP US ACHIEVE PRECISION

The basis for precision nozzle development

At Lechler, exact measurements have long been the basis for clearly defined spray characteristics. The data obtained in our laboratories form the foundation for any development and make it easier for our customers to choose nozzles for specific applications. This saves time, lowers costs and provides planning security.

Advanced technology

We have further expanded our research capacities by opening our own Development and Technology Center.

A highlight here is a laser-assisted phase doppler anemometer. As one of the most modern optical measuring procedures, it measures the velocity and the diameter of spherical droplets simultaneously and without contact. Using the data obtained, spectra can be reliably derived for particle size distributions and velocities.

International cooperation

We at Lechler value the importance of international cooperation. For this is often what opens up new perspectives on a problem. In addition, cooperation offers us the possibility of testing nozzles in very special test environments and of discovering new use scenarios in this way.

Measurements range from tiny water droplets in the micrometer region to very large droplets of around 8 millimeters. These are performed with a high temporal and spatial resolution.

Individual positions in the spray can be automatically approached and measured with extremely high accuracy – in x, y and z directions.

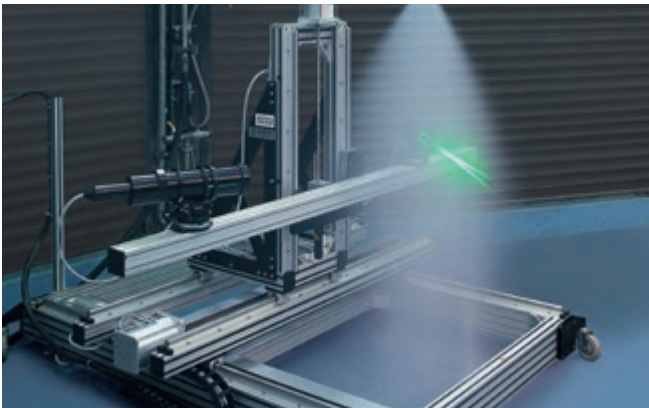

Our unique selling proposition: Practice-based knowledge

Since it was founded, Lechler has stood out for its development of new technologies. In more than a century we have successfully filed a large number of patents. Starting with the “Centrifugal Sprayer” from 1893 and going up to state-of-the-art technologies of the 21st Century. We will continue this proud tradition into the future, and our new technical center will be key to doing so. After seven years of construction, the Lechler Development and Technology Center was opened in the summer of 2016. Since then it has offered everything nozzle developers dream of on a surface of over 600 m². In addition to extensive measuring facilities, state-of-the-art test benches with a wide range of pump performances are available to measure and investigate sprays, from microfine mist to fuller sprays with varying jetting characteristics.

MEASURING TECHNOLOGY THE LECHLER DEVELOPMENT AND TECHNOLOGY CENTER

Our measurement range:

- Precise and reproducible measurement of droplet sizes and speeds in sprays
- Measurement of complete sprays or of local positions in a spray
- Documentation of the spectra for particle size distribution and velocities
- Determination of the Sauter mean diameter and of many other variables relevant for process engineering
- Measurement of very dense sprays using state-of-the-art laser technology
- Measurement of tiniest droplets in the μm region and measurement of very large drops of up to 8 mm
- Measurement of droplet velocities up to 200 m/s
- High temporal and spatial resolution
- Positions in the spray can be automatically approached and measured with extremely high accuracy – in a 3-dimensional space in x, y and z directions
- Very large measuring range allows measurement of very wide particle spectra
- The size and velocity of each individual droplet is detected
- Error-free results in accordance with ISO 9001
- Spray characteristics over area mapped in 3D
- Detection of positive and negative velocity components

Measurement validation of our calculation models taking the example of a gas cooling tower

Key figures of our experimental cooler with industry partners:

- Approx. two megawatts of thermal performance
- Use of single-fluid and twin-fluid nozzles under the most realistic conditions possible
- Flexible variation of inlet and outlet temperatures
- Monitoring of droplet sizes and numbers in several levels
- Detection of the evaporation rates of injected sprays
- Use of more than 50 sensors of different kinds for the precise detection of all operating parameters

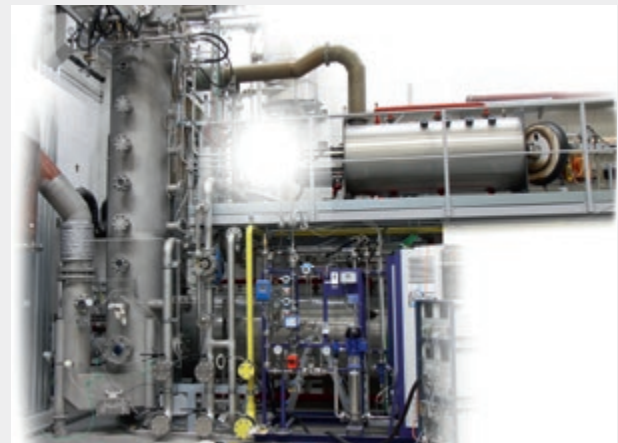

QUALITY WITH A SYSTEM

Lechler products are used in a wide variety of sectors and applications.

Which is why the products' requirements are often very specific to certain applications. We define the term "quality" as the extent to which our products fulfill our customers' individual requirements.



We are certified according to internationally recognized standards. Conscientious working and constant quality controls have always been carried out at Lechler, from materials receiving, development and production right through to shipping. So that our products keep what we promise in their daily use.



Talk to us

Your requirements are the first step towards a solution. We are more than happy to help you solve your individual tasks. Tell us your objectives and we will take care of the solution. If the solution is not yet available, we will tailor-make one for you. That is our promise.

FOR YOUR QUESTIONS

QUESTIONNAIRE

Nobody knows your process and requirements better than you. Your knowledge is critical to us in order to find the optimal nozzle for your application.

Simply send us the completed questionnaire or enter your information online.



Data collection sheet for design of a gas cooling system



Data collection sheet for design of a DeNOx system

FULL INFORMATION IS JUST A CLICK AWAY: THE LECHLER WEBSITE



Our website contains further information on our products as well as useful resources.

www.lechler.com

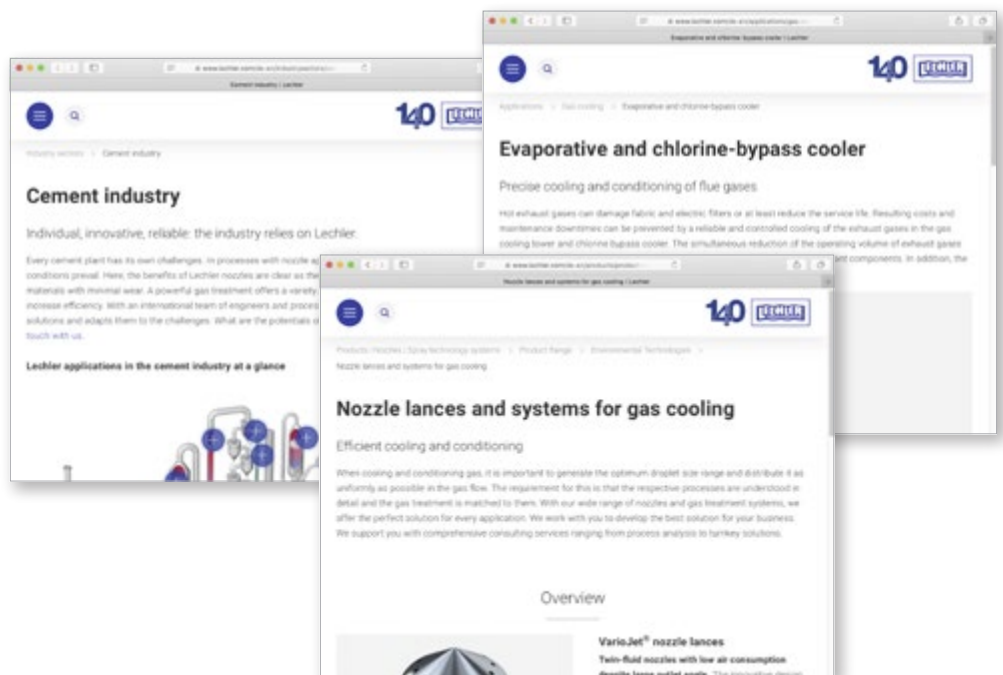

FOR YOUR NOTES





**ENGINEERING
YOUR SPRAY SOLUTION**



Lechler GmbH · Precision Nozzles · Nozzle Systems

Ulmer Strasse 128 · 72555 Metzingen, Germany · Phone +49 7123 962-0 · aqcs@lechler.de · www.lechler.com

ASEAN: Lechler Spray Technology Sdn. Bhd. · 22, Jln. Astaka 4B/KU2 · Bdr. Bukit Raja · 41050 Klang · Malaysia · Phone +603 3359 1118 · info@lechler.com.my

Belgium: Lechler S.A./N.V. · Avenue Newton 4 · 1300 Wavre · Phone +32 10 225022 · info@lechler.be

China: Lechler Nozzle Systems (Changzhou) Co., Ltd. · No.99 Decheng Rd, Jintan, Changzhou, JS 213200, P.R.C · Phone +86 519-6822 8088 · info@lechler.com.cn

Finland: Lechler Oy · Ansatie 6 a C 3 krs · 01740 Vantaa · Phone +358 207 856880 · info@lechler.fi

France: Lechler France SAS · Bât. CAP2 · 66-72 Rue Marceau · 93100 Montreuil · Phone +33 1 49882600 · info@lechler.fr

Great Britain: Lechler Ltd. · 1 Fell Street, Newhall · Sheffield, S9 2TP · Phone +44 114 2492020 · info@lechler.com

India: Lechler (India) Pvt. Ltd. · Plot B-2 · Main Road · Wagle Industrial Estate Thane · 400604 Maharashtra · Phone +91 22 40634444 · lechler@lechlerindia.com

Italy: Lechler Spray Technology S.r.l. · Via Don Dossetti, 2 · 20080 Carpiano (Mi) · Phone +39 2 98859027 · info@lechleritalia.com

Spain: Lechler, S.A. · C / Isla de Hierro, 7 – Oficina 1.3 · 28703 San Sebastián de los Reyes (Madrid) · Phone +34 91 6586346 · info@lechler.es

Sweden: Lechler AB · Kungsängsvägen 31B · 753 23 Uppsala · Phone +46 18 167030 · info@lechler.se

USA: Lechler Inc. · 445 Kautz Road · St. Charles, IL 60174 · Phone +1 630 3776611 · info@lechlerusa.com



Edition 08/22 · EN · www.dgm-kommunikation.de
Subject to technical modifications and mistakes.